



## Features

- RoHS compliant\*
- Low capacitance ~ 2.5 pF
- ESD protection
- Surge protection

## Applications

- Personal Digital Assistants (PDAs)
- Mobile phones & accessories
- Memory card protection
- SIM card port protection
- Portable electronics

# CDSOT23-SLVU2.8 - Surface Mount TVS Diode

## General Information

The CDSOT23-SLVU2.8 device provides ESD, EFT and Surge protection for high speed data ports meeting IEC 61000-4-2 (ESD), IEC 61000-4-4 (EFT) and IEC 61000-4-5 (Surge) requirements. The Transient Voltage Suppressor Array offers a Working Peak Reverse Voltage of 2.8 V and Minimum Breakdown Voltage of 3 V.

The SOT23 packaged device will mount directly onto the industry standard SOT23 footprint. Bourns® Chip Diodes conform to JEDEC standards, are easy to handle with standard pick and place equipment and the flat configuration minimizes roll away.

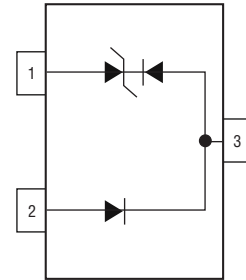

## Electrical Characteristics (@ T<sub>A</sub> = 25 °C Unless Otherwise Noted)

Parameter	Symbol	Value	Unit
Peak Pulse Power (t <sub>p</sub> = 8/20 μs) <sup>1</sup>	P <sub>PK</sub>	600	W
Peak Pulse Current (t <sub>p</sub> = 8/20 μs)	I <sub>PPM</sub>	30	A
Storage Temperature	T <sub>STG</sub>	-55 to +150	°C
Operating Temperature	T <sub>OPR</sub>	-55 to +150	°C
Minimum Breakdown Voltage @ 1 mA	V <sub>BR</sub>	3.0	V
Minimum Snap Back Voltage @ 50 mA	V <sub>BR</sub>	2.8	V
Maximum Working Peak Voltage	V <sub>WM</sub>	2.8	V
Maximum Leakage Current @ V <sub>WM</sub> (Pin 3 to Pin 1) or (Pin 2 to Pin 1)	I <sub>D</sub>	1.0	μA
Maximum Clamping Voltage @ I <sub>p</sub> = 2 A	V <sub>C</sub>	5.5	V
Maximum Clamping Voltage @ I <sub>p</sub> = 5 A (Pin 2 to Pin 1)	V <sub>C</sub>	7.0 8.5	V
Maximum Clamping Voltage @ I <sub>p</sub> = 30 A	V <sub>C</sub>	21.0	V
Typical Junction Capacitance @ 0 V, 1 MHz (Pin 3 to Pin 1 & Pin 2) (Pin 2 to Pin 1 with Pin 3 NC)	C <sub>D</sub>	20 2.5	pF
Maximum Junction Capacitance @ 0 V, 1 MHz	C <sub>D</sub>	3	pF
Maximum Peak Reverse Voltage @ I = 10 μA	V <sub>RRM</sub>	40	V
Maximum Reverse Leakage Current @ V <sub>WM</sub>	I <sub>DR</sub>	0.1	μA
Maximum Forward Voltage @ I <sub>F</sub> = 1 A, 120 μS	V <sub>F</sub>	2	V

Note:

1. See Peak Pulse Power vs. Pulse Time.

\*RoHS Directive 2002/95/EC Jan. 27, 2003 including annex and RoHS Recast 2011/65/EU June 8, 2011.

Specifications are subject to change without notice.

The device characteristics and parameters in this data sheet can and do vary in different applications and actual device performance may vary over time. Users should verify actual device performance in their specific applications.

# CDSOT23-SLVU2.8 - Surface Mount TVS Diode



## Product Dimensions

This is a molded JEDEC SOT-323 package with 100 % Matte Sn plating on the lead frame. It weighs approximately 8 mg and has a flammability rating of UL 94V-0.

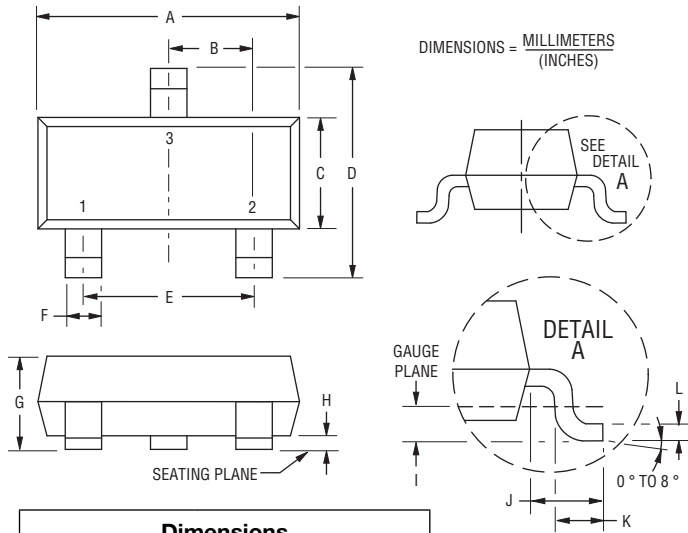

Dimensions	
A	$\frac{2.80 - 3.00}{(0.110 - 0.118)}$
B	$\frac{0.95}{(0.037)}$ BSC
C	$\frac{1.20 - 1.40}{(0.047 - 0.055)}$
D	$\frac{2.10 - 2.49}{(0.083 - 0.098)}$
E	$\frac{1.90}{(0.075)}$ BSC
F	$\frac{0.30 - 0.50}{(0.012 - 0.019)}$
G	$\frac{0.89 - 1.17}{(0.035 - 0.046)}$
H	$\frac{0.05 - 0.015}{(0.002 - 0.006)}$
I	$\frac{0.25}{(0.010)}$ BSC
J	$\frac{0.46 - 0.64}{(0.018 - 0.025)}$
K	$\frac{0.40 - 0.58}{(0.016 - 0.023)}$
L	$\frac{0.08 - 0.20}{(0.003 - 0.008)}$

## Recommended Footprint

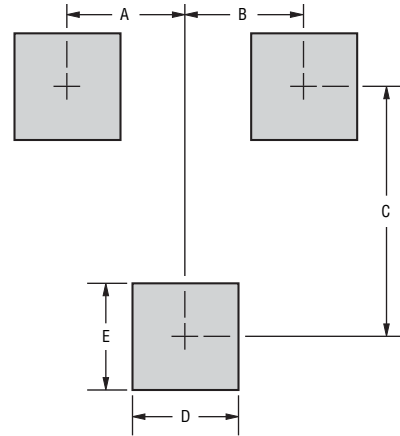

DIMENSIONS = MILLIMETERS (INCHES)

Dimensions	
A	$\frac{0.95}{(0.037)}$
B	$\frac{0.95}{(0.037)}$
C	$\frac{2.00}{(0.079)}$
D	$\frac{0.85}{(0.033)}$
E	$\frac{0.85}{(0.033)}$

## How to Order

**CD SOT23 - SLVU 2.8**

Common Code \_\_\_\_\_  
 Chip Diode \_\_\_\_\_  
 Package \_\_\_\_\_  
 • SOT23 = SOT23 Package  
 Model \_\_\_\_\_  
 SLVU = Special Model  
 Working Peak Reverse Voltage \_\_\_\_\_  
 2.8 = 2.8 V<sub>RWM</sub> (Volts)

## Typical Part Marking

CDSOT23-SLVU2.8 .....SLA

Specifications are subject to change without notice. The device characteristics and parameters in this data sheet can and do vary in different applications and actual device performance may vary over time. Users should verify actual device performance in their specific applications.

# CDSOT23-SLVU2.8 - Surface Mount TVS Diode

**BOURNS®**

## Performance Graphs

### Peak Pulse Power vs. Pulse Time

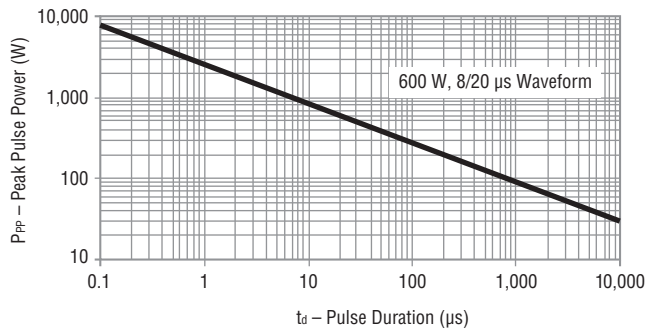

### Pulse Waveform

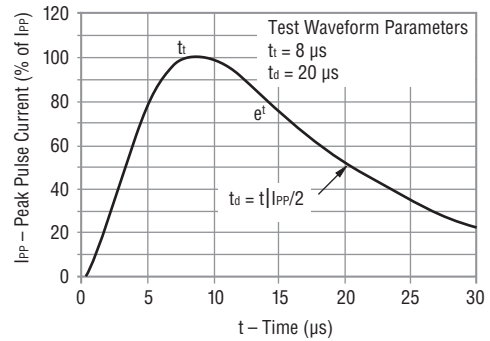

### Overshoot & Clamping Voltage

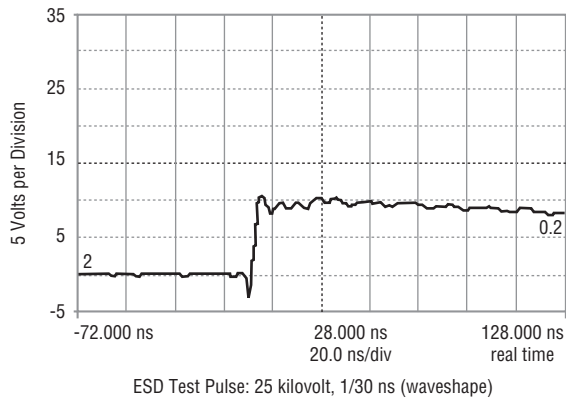

### Power Derating Curve

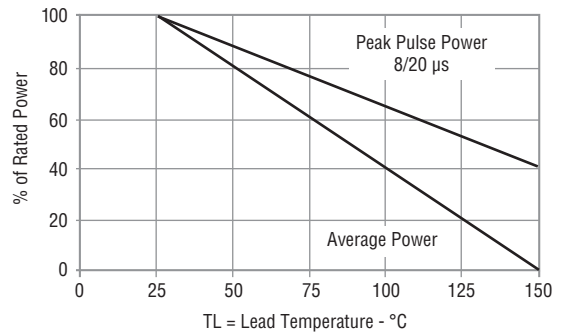

Specifications are subject to change without notice.

The device characteristics and parameters in this data sheet can and do vary in different applications and actual device performance may vary over time. Users should verify actual device performance in their specific applications.

# CDSOT23-SLVU2.8 - Surface Mount TVS Diode

**BOURNS®**

## Packaging Information

The surface mount product is packaged in an 8 mm x 4 mm tape and reel format per EIA-481 standard.

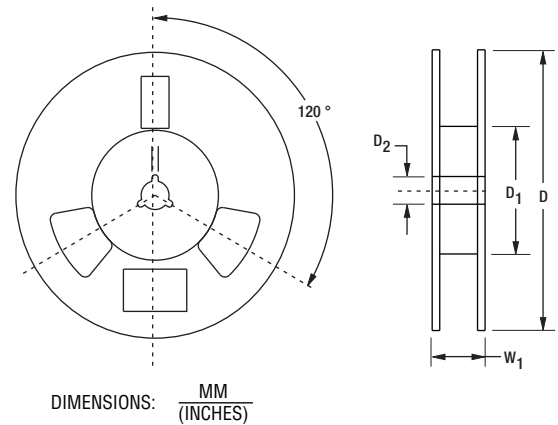
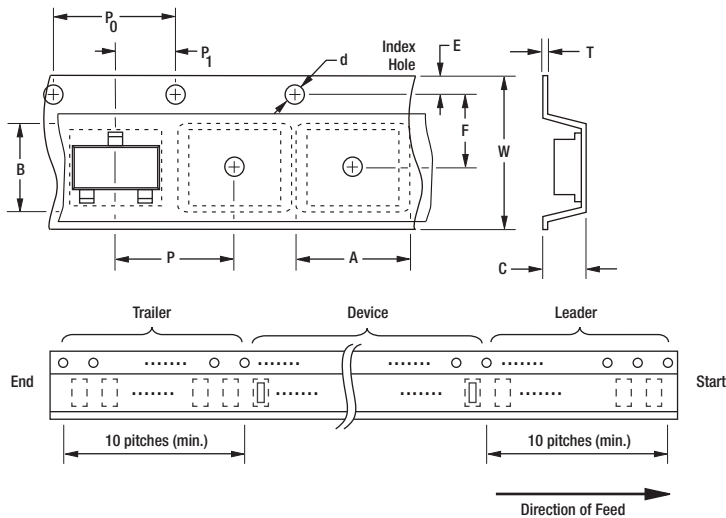

Devices are packed in accordance with EIA standard RS-481-A.

Item	Symbol	SOT23
Carrier Width	A	$\frac{2.25 \pm 0.10}{(0.088 \pm 0.004)}$
Carrier Length	B	$\frac{2.34 \pm 0.10}{(0.092 \pm 0.004)}$
Carrier Depth	C	$\frac{1.22 \pm 0.10}{(0.048 \pm 0.004)}$
Sprocket Hole	d	$\frac{1.55 \pm 0.05}{(0.061 \pm 0.002)}$
Reel Outside Diameter	D	$\frac{178}{(7.008)}$
Reel Inner Diameter	D <sub>1</sub>	$\frac{50.0}{(1.969)}$ MIN.
Feed Hole Diameter	D <sub>2</sub>	$\frac{13.0 \pm 0.20}{(0.512 \pm 0.008)}$
Sprocket Hole Position	E	$\frac{1.75 \pm 0.10}{(0.069 \pm 0.004)}$
Punch Hole Position	F	$\frac{3.50 \pm 0.05}{(0.138 \pm 0.002)}$
Punch Hole Pitch	P	$\frac{4.00 \pm 0.10}{(0.157 \pm 0.004)}$
Sprocket Hole Pitch	P <sub>0</sub>	$\frac{4.00 \pm 0.10}{(0.157 \pm 0.004)}$
Embossment Center	P <sub>1</sub>	$\frac{2.00 \pm 0.05}{(0.079 \pm 0.002)}$
Overall Tape Thickness	T	$\frac{0.20 \pm 0.10}{(0.008 \pm 0.004)}$
Tape Width	W	$\frac{8.00 \pm 0.20}{(0.315 \pm 0.008)}$
Reel Width	W <sub>1</sub>	$\frac{14.4}{(0.567)}$ MAX.
Quantity per Reel	--	3,000

**BOURNS®**

### Asia-Pacific:

Tel: +886-2 2562-4117  
Fax: +886-2 2562-4116

### EMEA:

Tel: +36 88 520 390  
Fax: +36 88 520 211

### The Americas:

Tel: +1-951 781-5500  
Fax: +1-951 781-5700

[www.bourns.com](http://www.bourns.com)

REV. 11/13

Specifications are subject to change without notice. The device characteristics and parameters in this data sheet can and do vary in different applications and actual device performance may vary over time. Users should verify actual device performance in their specific applications.