

Glass Passivated Single-Phase Bridge Rectifiers

FEATURES

- Thin Single in-line low profile package ideal for compact required circuit
- Glass passivated junction
- High surge current capability
- Compliant to RoHS Directive 2011/65/EU and in accordance to WEEE 2002/96/EC
- Halogen-free according to IEC 61249-2-21 definition



MECHANICAL DATA

Case: KBJL

Molding compound, UL flammability classification rating 94V-0

Terminal: Matte tin plated leads, solderable per JESD22-B102
Meet JESD 201 class 1A whisker test

Polarity: As marked

Mounting torque: 0.5N.m is recommended

Weight: 2.6g (approximately)

KBJL

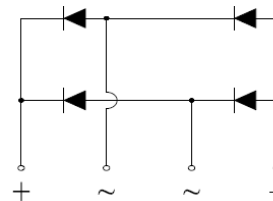

MAXIMUM RATINGS AND ELECTRICAL CHARACTERISTICS (T _J =25°C unless otherwise noted)					
PARAMETER	SYMBOL	TS6KL60	TS6KL80	TS6KL100	UNIT
Maximum repetitive peak reverse voltage	V _{RRM}	600	800	1000	V
Maximum RMS voltage	V _{RMS}	420	560	700	V
Maximum DC blocking voltage	V _{DC}	600	800	1000	V
Maximum average forward rectified current	I _{F(AV)}	6			A
Non-repetitive peak forward surge current 8.3ms single sine-wave	I _{FSM}	150			A
Non-repetitive peak forward surge current 1ms single sine-wave	I _{FSM}	280			A
Rating of fusing (t<8.3ms)	i ² T	93			A ² s
Maximum Instantaneous Forward Voltage (Note 1) IF= 3A	V _F	1.05			V
Maximum reverse current @ rated VR T _J =25 °C T _J =125 °C	I _R	5 150			μA
Typical thermal resistance (Note 2)	R _{θJC}	2			°C/W
	R _{θJA}	7			°C/W
Operating junction temperature range	T _J	- 55 to +150			°C
Storage temperature range	T _{STG}	- 55 to +150			°C

Note 1: Pulse test with PW=300μs, 1% duty cycle

Note 2: Mount on Heatsink size of 4" x 6" x 0.25" Al-Plate

ORDERING INFORMATION			
PART NO.	PACKING CODE	PACKAGE	PACKING
TS6KLXX (Note 1)	D3	KBJL	25 / Tube

Note 1: "xx" defines voltage from 600V (TS6KL60) to 1000V (TS6KL100)

EXAMPLE			
PREFERRED P/N	PART NO.	PACKING CODE	DESCRIPTION
TS6KL80 D3	TS6KL80	D3	

RATINGS AND CHARACTERISTICS CURVES

(TA=25°C unless otherwise noted)

FIG.1 FORWARD CURRENT DERATING CURVE

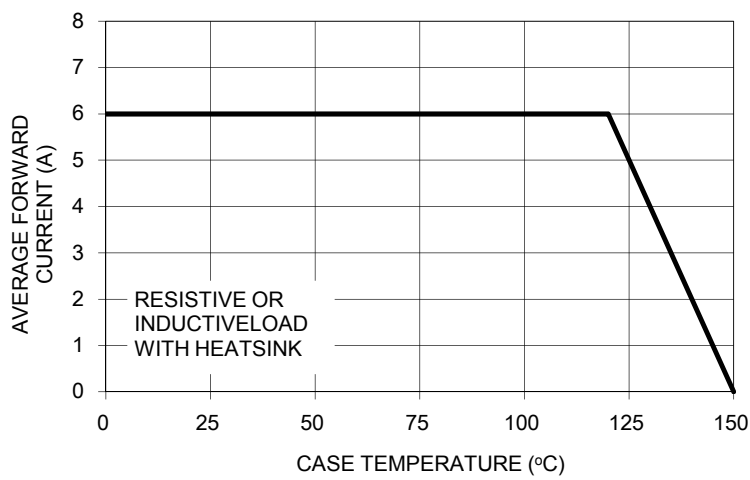

FIG. 2- MAXIMUM NON-REPETITIVE FORWARD SURGE CURRENT

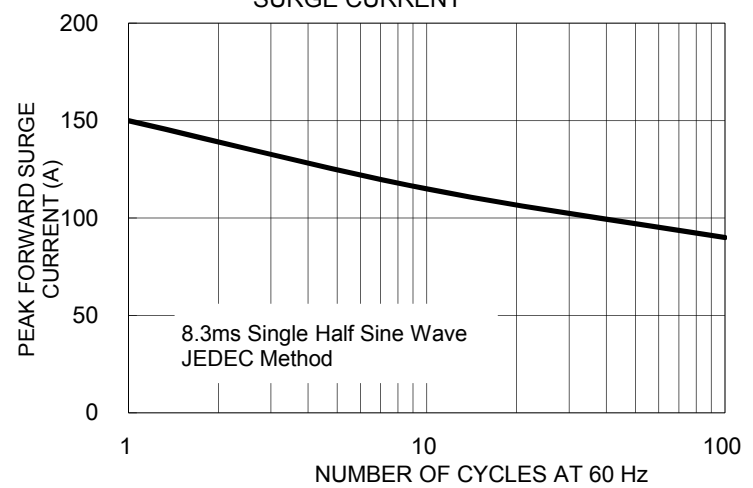

FIG. 3- TYPICAL FORWARD CHARACTERISTICS

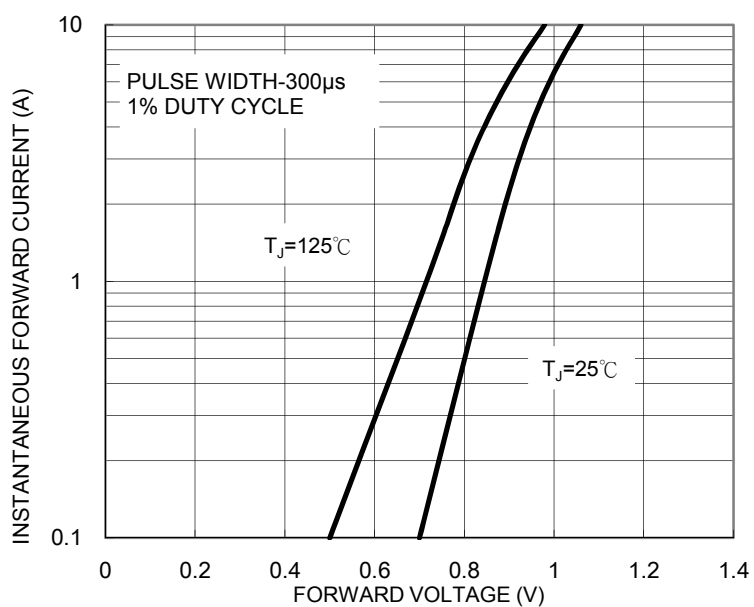

FIG. 4- TYPICAL REVERSE CHARACTERISTICS

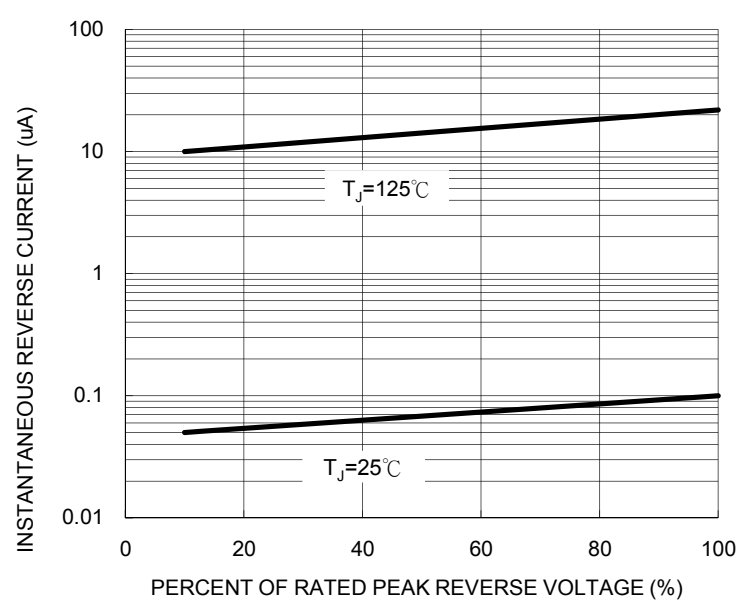
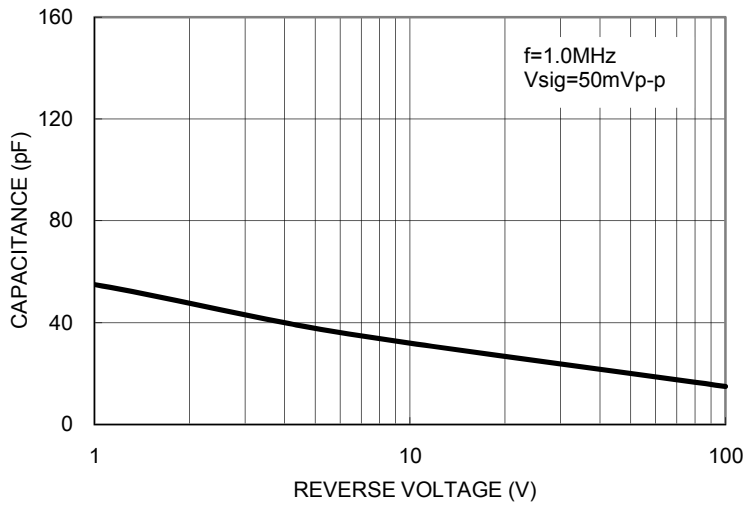
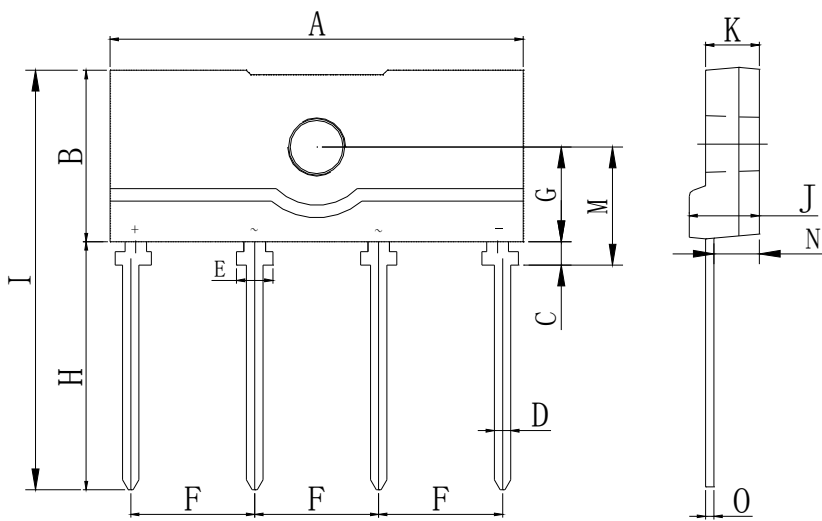

FIG. 5- TYPICAL JUNCTION CAPACITANCE



PACKAGE OUTLINE DIMENSIONS



DIM.	Unit (mm)		Unit (inch)	
	Min	Max	Min	Max
A	24.70	25.30	0.972	0.996
B	10.00	10.60	0.394	0.417
C	1.20	1.60	0.047	0.063
D	0.90	1.10	0.035	0.043
E	2.10	2.30	0.083	0.091
F	7.30	7.70	0.287	0.303
G	5.50	5.90	0.217	0.232
H	14.40	15.40	0.567	0.606
I	24.90	25.50	0.980	1.004
J	4.00	4.40	0.157	0.173
K	3.00	3.40	0.118	0.134
M	6.90	7.30	0.272	0.287
N	2.50	2.90	0.098	0.114
O	0.30	0.70	0.012	0.028

MARKING DIAGRAM

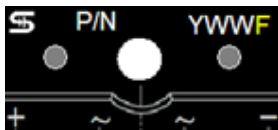

P/N = Specific Device Code
 YWW = Date Code
 F = Factory Code