



# MIC5282

120V<sub>IN</sub>, 50mA, Ultra-Low I<sub>Q</sub>, High-PSRR  
Linear Regulator

## General Description

The MIC5282 high-performance linear regulator offers a very-wide input operating voltage range, up to 120V DC, and supplies an output current of up to 50mA.

Ideal for high input voltage applications such as industrial and telecom, the MIC5282 offers  $\pm 3\%$  initial accuracy, extremely high-power supply rejection ratio (80dB at 10kHz) and ultra-low quiescent current of 6 $\mu$ A. The MIC5282 is optimized for high-voltage line transients, making it ideal for harsh environment applications.

The MIC5282 is offered in both fixed output voltage (3.3V/5.0V) and adjustable output voltage (1.27V to 5.5V) options.

The MIC5282 operates over a  $-40^{\circ}\text{C}$  to  $+125^{\circ}\text{C}$  temperature range and is available in lead-free, RoHS-compliant, 8-pin ePad MSOP and 8-pin MSOP packages.

Data sheet and support documentation are found on the Micrel website: [www.micrel.com](http://www.micrel.com).

## Features

- Wide input voltage range: 6V to 120V DC
- Ultra-low quiescent current: 6 $\mu$ A
- 50mA guaranteed output current
- Adjustable output from 1.27V to 5.5V
- Withstands up to +120V DC at the input
- Stable with ceramic capacitors
- Ultra-high PSRR (80dB at 10kHz)
- Ultra-high line rejection (load dump)
- High output accuracy:
  - $\pm 3\%$  initial accuracy
- Thermal-shutdown and current-limit protection
- Thermally-efficient, 8-pin MSOP and 8-pin ePad MSOP packages

## Applications

- Industrial
- Remote keyless entry power supply
- Telecom
- Off-line power supplies

## Typical Applications

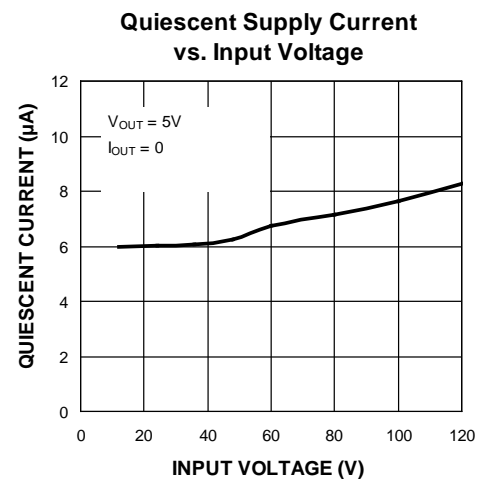
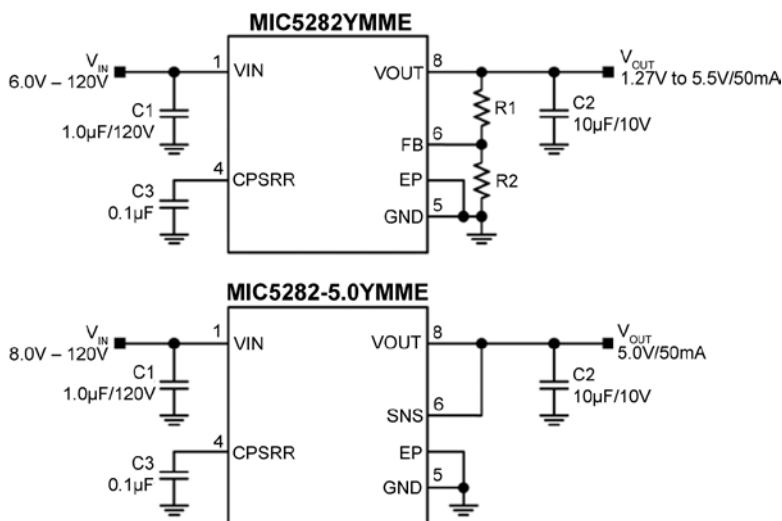

## Ordering Information

| Part Number     | Output Voltage | Top Mark | Temperature Range | Package         | Lead Finish |
|-----------------|----------------|----------|-------------------|-----------------|-------------|
| MIC5282YMME     | Adjustable     | A882     | -40°C to +125°C   | 8-Pin ePad MSOP | Pb-Free     |
| MIC5282-3.3YMME | 3.3V           | 882S     | -40°C to +125°C   | 8-Pin ePad MSOP | Pb-Free     |
| MIC5282-5.0YMME | 5.0V           | 5882     | -40°C to +125°C   | 8-Pin ePad MSOP | Pb-Free     |
| MIC5282YMM      | Adjustable     | -        | -40°C to +125°C   | 8-Pin MSOP      | Pb-Free     |
| MIC5282-3.3YMM  | 3.3V           | -        | -40°C to +125°C   | 8-Pin MSOP      | Pb-Free     |
| MIC5282-5.0YMM  | 5.0V           | -        | -40°C to +125°C   | 8-Pin MSOP      | Pb-Free     |

## Pin Configuration

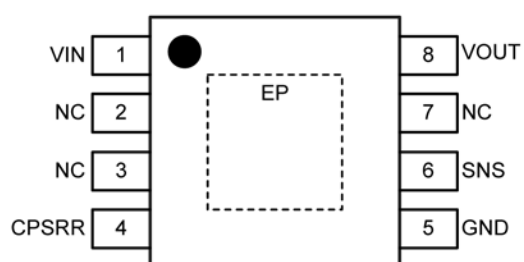

**8-Pin ePAD MSOP  
MIC5282-x.xYMME**

(TOP VIEW)

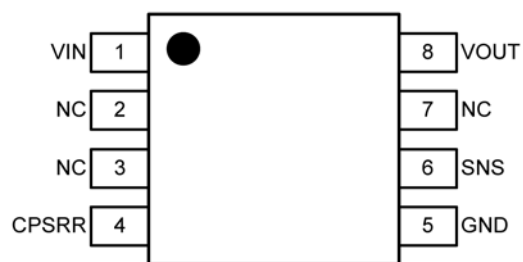

**8-Pin MSOP  
MIC5282-x.xYMM**

(TOP VIEW)

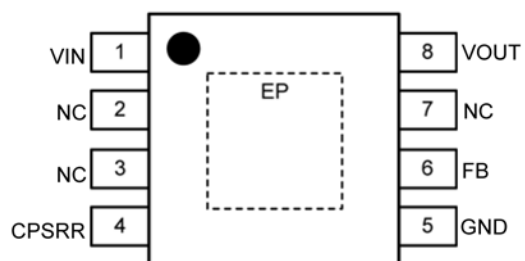

**8-Pin ePAD MSOP  
MIC5282YMME**

(TOP VIEW)

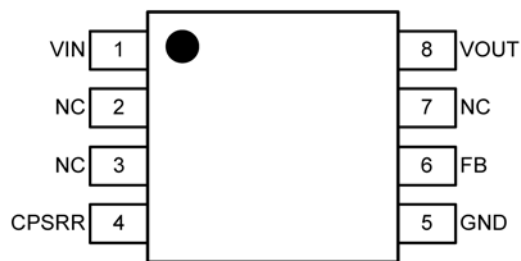

**8-Pin MSOP  
MIC5282YMM**

(TOP VIEW)

## Pin Description

| Pin         |                 |            |                | Name  | Function                                                                      |
|-------------|-----------------|------------|----------------|-------|-------------------------------------------------------------------------------|
| MIC5282YMME | MIC5282-x.xYMME | MIC5282YMM | MIC5282-x.xYMM |       |                                                                               |
| 1           | 1               | 1          | 1              | VIN   | Supply Voltage Input. Connect 1 $\mu$ F capacitor from VIN to GND.            |
| 2, 3, 7     | 2, 3, 7         | 2, 3, 7    | 2, 3, 7        | NC    | Not internally connected. Connect NC to GND or leave unconnected.             |
| 4           | 4               | 4          | 4              | CPSRR | Bypass Capacitor Connection. Connect 0.1 $\mu$ F capacitor from CPSRR to GND. |
| 5           | 5               | 5          | 5              | GND   | Ground.                                                                       |
| 6           | –               | 6          | –              | FB    | Feedback Connection. For external resistor divider to set V <sub>OUT</sub> .  |
| –           | 6               | –          | 6              | SNS   | Sense input. Connect SNS to V <sub>OUT</sub> .                                |
| 8           | 8               | 8          | 8              | VOUT  | Regulator Output. Connect 10 $\mu$ F capacitor from V <sub>OUT</sub> to GND.  |
| EP          | EP              | –          | –              | EP    | Exposed Pad (ePad) for Thermal Relief. Connect EP to GND.                     |

### Absolute Maximum Ratings<sup>(1)</sup>

|                                                                    |                                 |
|--------------------------------------------------------------------|---------------------------------|
| V <sub>IN</sub> to GND.....                                        | -0.3V to +125V                  |
| V <sub>CPSRR</sub> to GND.....                                     | -0.3 to +14V                    |
| V <sub>FB</sub> , V <sub>SNS</sub> , V <sub>OUT</sub> to GND ..... | -0.3V to +6V                    |
| Lead Temperature (soldering, 10s).....                             | +260°C                          |
| Junction Temperature .....                                         | -40°C ≤ T <sub>J</sub> ≤ +125°C |
| Storage Temperature .....                                          | -65°C ≤ T <sub>A</sub> ≤ +150°C |
| ESD Ratings <sup>(4)</sup>                                         |                                 |
| HBM .....                                                          | 2kV                             |
| MM.....                                                            | 200V                            |

### Operating Ratings<sup>(2)</sup>

|                                                |                                   |
|------------------------------------------------|-----------------------------------|
| V <sub>IN</sub> .....                          | +6V to +120V                      |
| V <sub>OUT</sub> Adjust Range .....            | +1.27V to +5.5V                   |
| Junction Temperature .....                     | -40°C ≤ T <sub>J</sub> ≤ +125°C   |
| Power Dissipation (P <sub>D</sub> ).....       | Internally Limited <sup>(3)</sup> |
| Junction Thermal Resistance (θ <sub>JA</sub> ) |                                   |
| 8-pin ePad MSOP.....                           | 64°C/W                            |
| 8-pin MSOP .....                               | 160°C/W                           |

### Electrical Characteristics<sup>(5)</sup>

V<sub>IN</sub> = 12V, C<sub>IN</sub> = 1.0μF, C<sub>PSRR</sub> = 0.1μF, C<sub>OUT</sub> = 10μF, V<sub>OUT</sub> = 5.0V or 3.3V, I<sub>OUT</sub> = 100μA, T<sub>A</sub> = 25°C, **bold** values indicate -40°C ≤ T<sub>J</sub> ≤ +125°C, unless noted.

| Parameter                                   | Condition                               | Min.         | Typ.        | Max.         | Units       |   |
|---------------------------------------------|-----------------------------------------|--------------|-------------|--------------|-------------|---|
| <b>Power Supply Input</b>                   |                                         |              |             |              |             |   |
| Input Voltage Range <sup>(6)</sup>          |                                         | 6            |             | 120          | V           |   |
| Quiescent Supply Current <sup>(7)</sup>     | I <sub>OUT</sub> = 0                    |              | 6           | <b>11</b>    | μA          |   |
| <b>Output Voltage</b>                       |                                         |              |             |              |             |   |
| Output Voltage                              | Adjustable                              | 1.27         |             | 5.5          | V           |   |
|                                             | Fixed 3.3V                              | 3.2          | 3.3         | 3.4          |             |   |
|                                             |                                         | <b>3.13</b>  | 3.3         | <b>3.47</b>  |             |   |
|                                             | Fixed 5.0V                              | 4.85         | 5.0         | 5.15         |             |   |
| <b>4.75</b>                                 |                                         | 5.0          | <b>5.25</b> |              |             |   |
| Output Voltage Accuracy                     | Variation from nominal V <sub>OUT</sub> | -3           |             | +3           | %           |   |
|                                             |                                         | <b>-5</b>    |             | <b>+5</b>    | %           |   |
| Load Regulation                             | I <sub>OUT</sub> = 100μA to 50mA        | ePad         | <b>-1.0</b> | 0.5          | <b>+1.0</b> | % |
|                                             |                                         | non-ePad     | <b>-1.2</b> | 0.6          | <b>+1.2</b> |   |
| Line Regulation <sup>(8)</sup>              | V <sub>IN</sub> = 10V to 120V           | <b>-0.5</b>  | 0.04        | <b>+0.5</b>  | %/V         |   |
| <b>Feedback Input (Adjustable)</b>          |                                         |              |             |              |             |   |
| FB Voltage                                  |                                         | 1.232        | 1.270       | 1.308        | V           |   |
|                                             |                                         | <b>1.206</b> | 1.270       | <b>1.333</b> |             |   |
| FB Current                                  | V <sub>FB</sub> = 1.27V                 |              | 3.2         |              | nA          |   |
| <b>Current Limit</b>                        |                                         |              |             |              |             |   |
| Current Limit                               | V <sub>OUT</sub> = 0V                   | <b>60</b>    | 125         | <b>260</b>   | mA          |   |
| <b>Ripple Rejection</b>                     |                                         |              |             |              |             |   |
| Power Supply Rejection Ratio <sup>(9)</sup> | 100Hz ≤ f ≤ 1kHz                        |              | 65          |              | dB          |   |
|                                             | 1kHz ≤ f ≤ 5kHz                         |              | 75          |              | dB          |   |
|                                             | 5kHz ≤ f ≤ 40kHz                        |              | 80          |              | dB          |   |
|                                             | 40kHz ≤ f ≤ 1MHz                        |              | 90          |              | dB          |   |

## Electrical Characteristics<sup>(5)</sup> (Continued)

$V_{IN} = 12V$ ,  $C_{IN} = 1.0\mu F$ ,  $C_{PSRR} = 0.1\mu F$ ,  $C_{OUT} = 10\mu F$ ,  $V_{OUT} = 5.0V$  or  $3.3V$ ,  $I_{OUT} = 100\mu A$ ,  $T_A = 25^\circ C$ , **bold** values indicate  $-40^\circ C \leq T_J \leq +125^\circ C$ , unless noted.

| Parameter                    | Condition        | Min. | Typ. | Max.     | Units      |
|------------------------------|------------------|------|------|----------|------------|
| <b>Power Dropout Voltage</b> |                  |      |      |          |            |
| Dropout Voltage              | $I_{OUT} = 50mA$ |      | 2    | <b>3</b> | V          |
| <b>Thermal Protection</b>    |                  |      |      |          |            |
| Thermal-Shutdown Temperature | $T_J$ rising     |      | 157  |          | $^\circ C$ |
| Thermal-Shutdown Hysteresis  |                  |      | 15   |          | $^\circ C$ |

### Notes:

1. Exceeding an absolute maximum rating may damage the device.
2. The device is not guaranteed to function outside its operating rating.
3. The maximum allowable power dissipation at any  $T_A$  (ambient temperature) is  $P_{D(max)} = (T_{J(max)} - T_A) / \theta_{JA}$ . Exceeding the maximum allowable power dissipation results in excessive die temperature, and causes the regulator to enter thermal shutdown.
4. Devices are ESD sensitive; use proper handling precautions.
5. Specifications are for packaged products only.
6. Assure that  $V_{IN} \geq (V_{OUT} + 3V)$  and  $V_{IN} \geq 6V$ .
7. Quiescent current is specified for the adjustable option. The fixed options will add approximately  $1\mu A$  due to the internal feedback resistors.
8. Line regulation is a percentage of  $V_{OUT}$ .
9. See Typical Characteristics Curve on Pg. 8

# Typical Characteristics

**Quiescent Supply Current vs. Input Voltage**

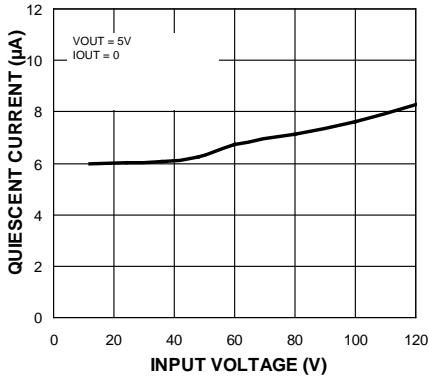

**Quiescent Supply Current vs. Temperature**

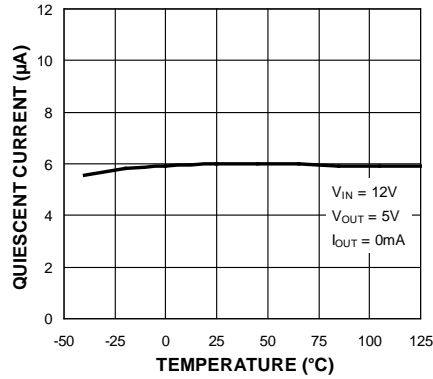

**Output Voltage vs. Input Voltage**

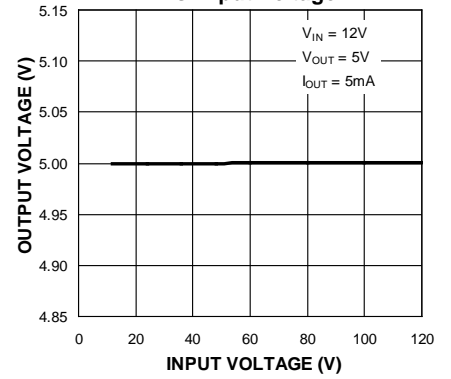

**Output Voltage vs. Output Current**

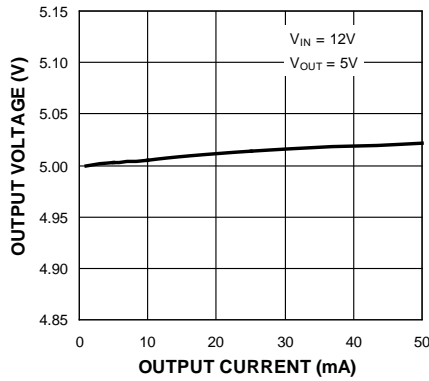

**Output Voltage vs. Temperature**

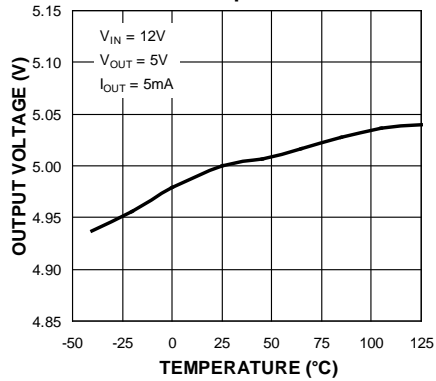

**Dropout Voltage vs. Output Current**

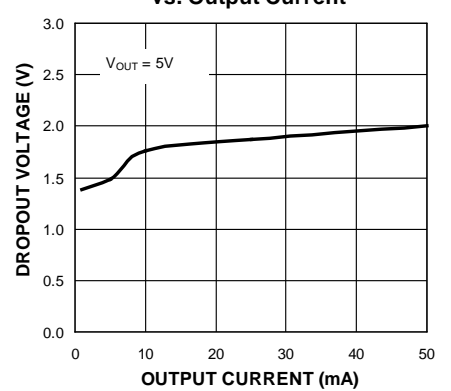

**Dropout Voltage vs. Temperature**

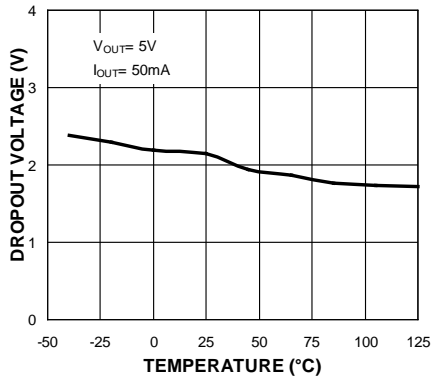

**Feedback Pin Voltage vs. Input Voltage**

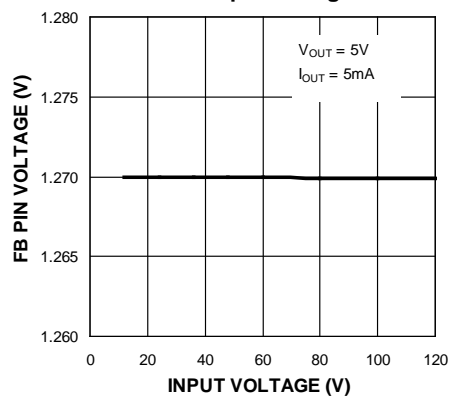

**Feedback Pin Current vs. Input Voltage**

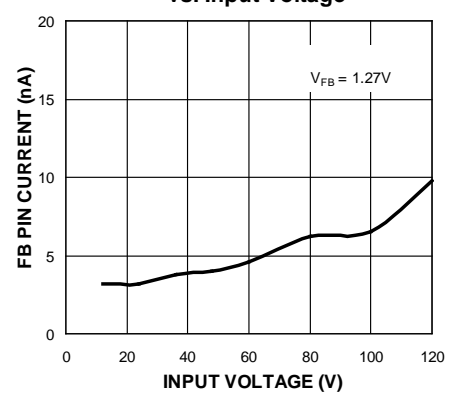

## Typical Characteristics (Continued)

**Feedback Pin Voltage vs. Temperature**

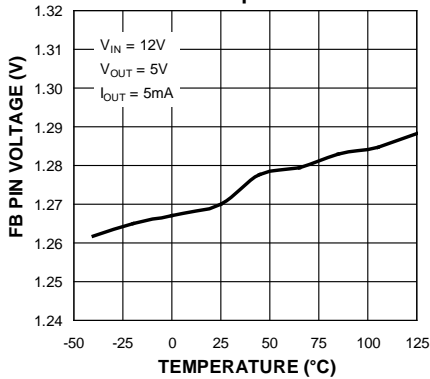

**Feedback Pin Current vs. Temperature**

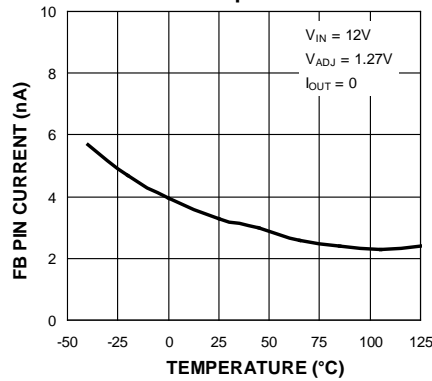

**Feedback Pin Voltage vs. Output Current**

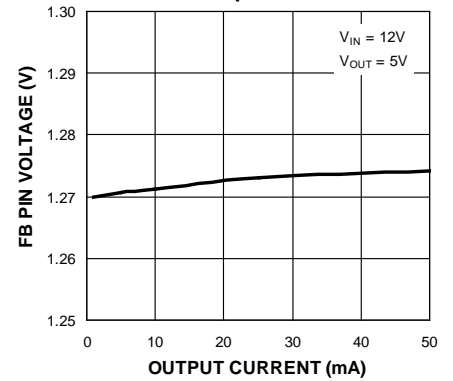

**Current Limit vs. Temperature**

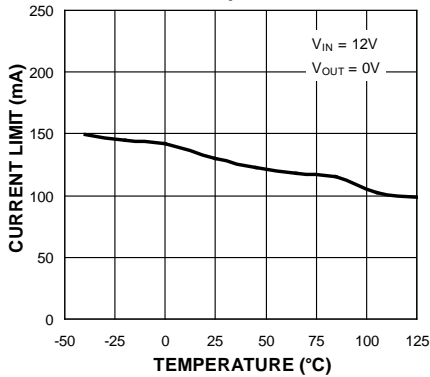

**Line Regulation vs. Temperature**

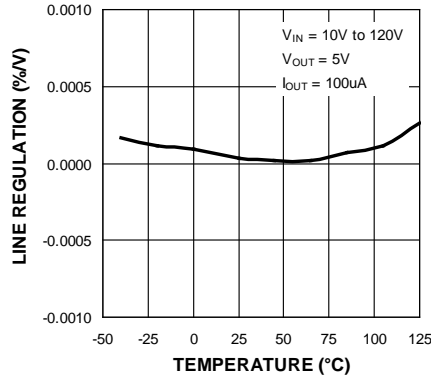

**Load Regulation vs. Temperature**

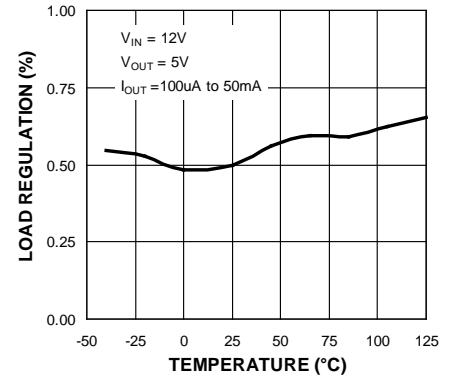

**Power Dissipation vs. Output Current**

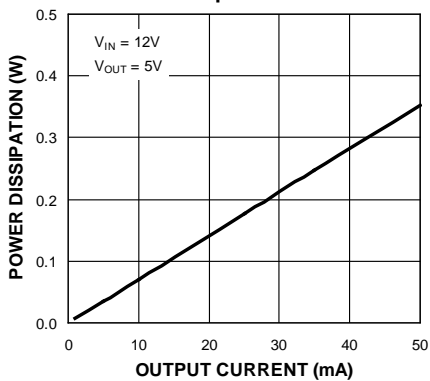

**Case Temperature\* (MME) vs. Output Current**

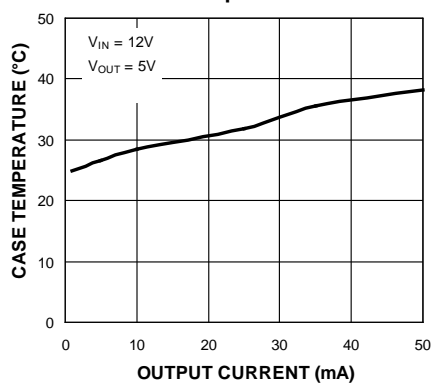

**PSRR vs. Frequency**

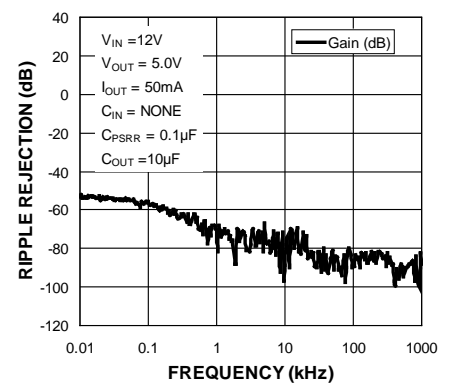

**Case Temperature\*:** The temperature measurement was taken at the hottest point on the MIC5282 case mounted on a 2.25 square inch PCB at an ambient temperature of 25°C; see “Thermal Measurement” section. Actual results will depend upon the size of the PCB, ambient temperature and proximity to other heat emitting components.

## Functional Characteristics

**Soft Turn-On into Full Load**

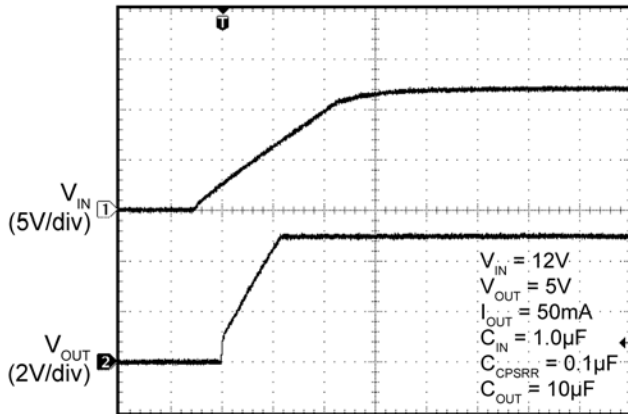

Time (4.00ms/div)

**Soft Turn-Off**

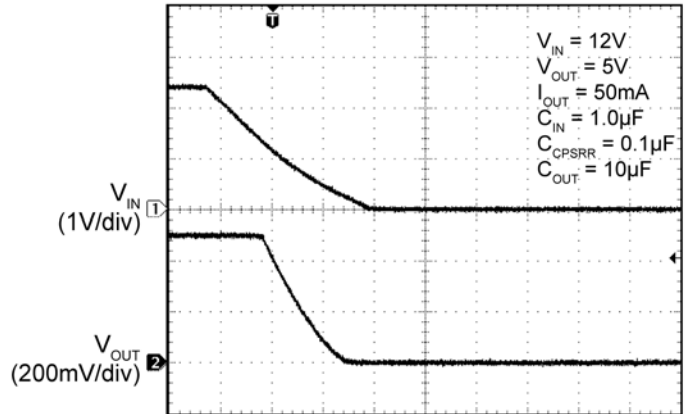

Time (20ms/div)

**Hot Plug**

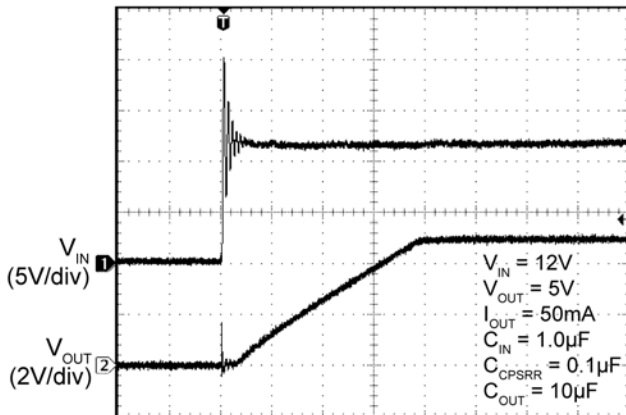

Time (100µs/div)

**Hot Un-Plug**

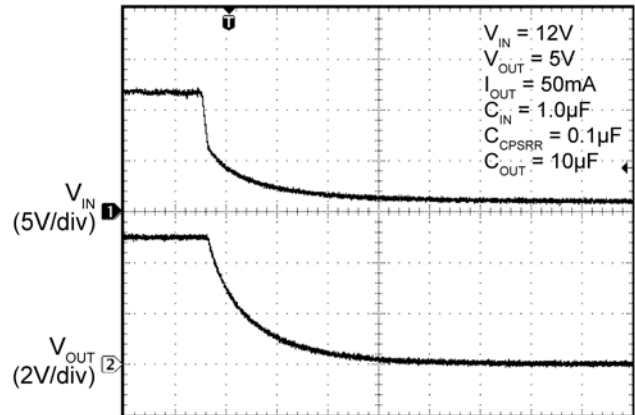

Time (1.00ms/div)

**$V_{IN}$  UVLO Threshold**

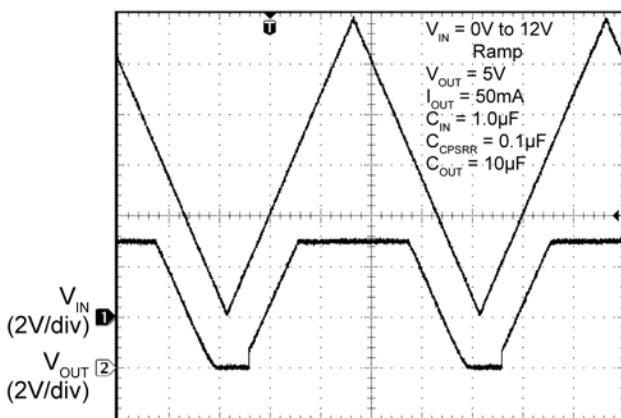

Time (200ms/div)

**Current Limit**

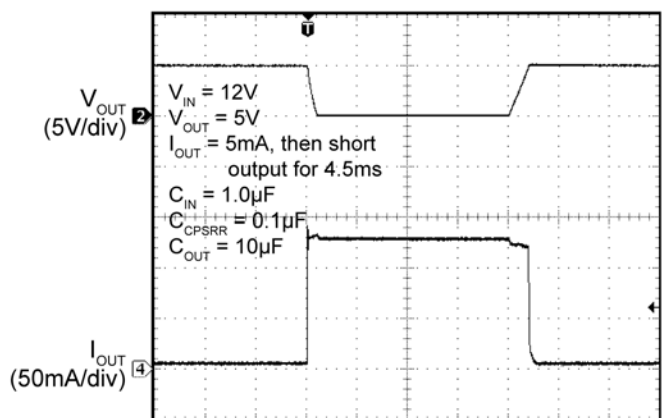

Time (1.00ms/div)



Functional Characteristics (Continued)

Thermal-Shutdown Response

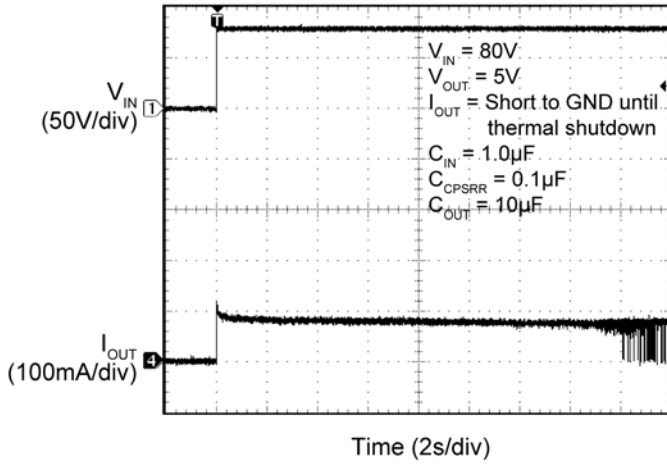

$V_{OUT}$  Recovery from Thermal Shutdown

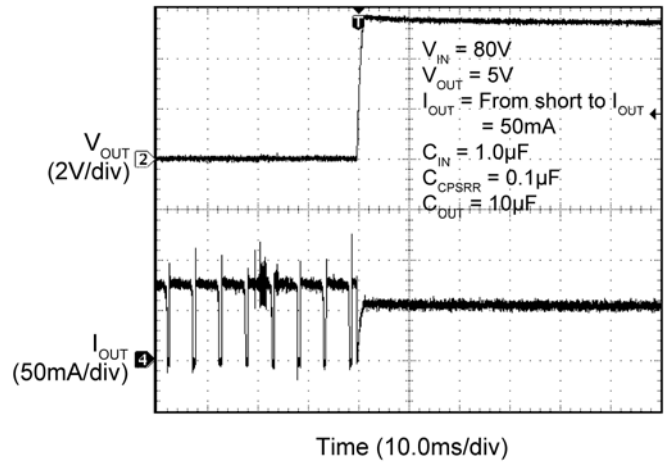

Turn-On into Short Circuit

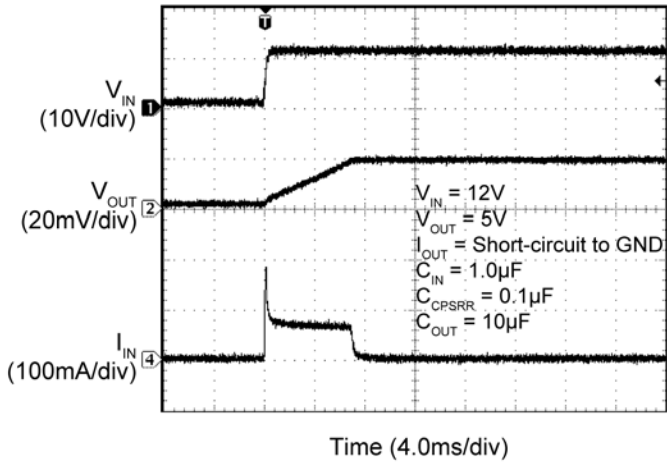

Inrush Current Response

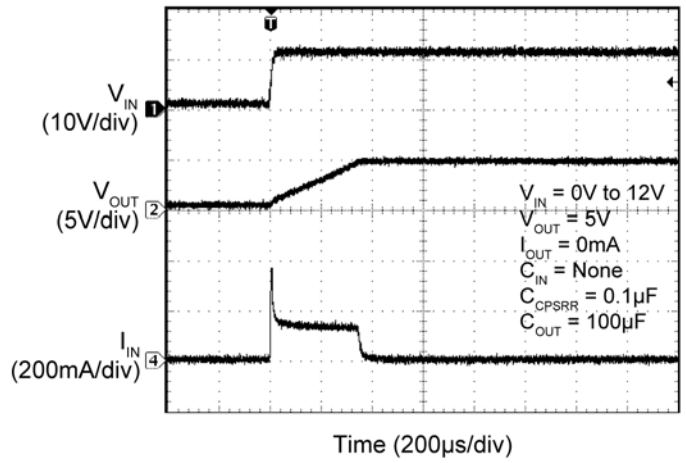

Load Transient Response

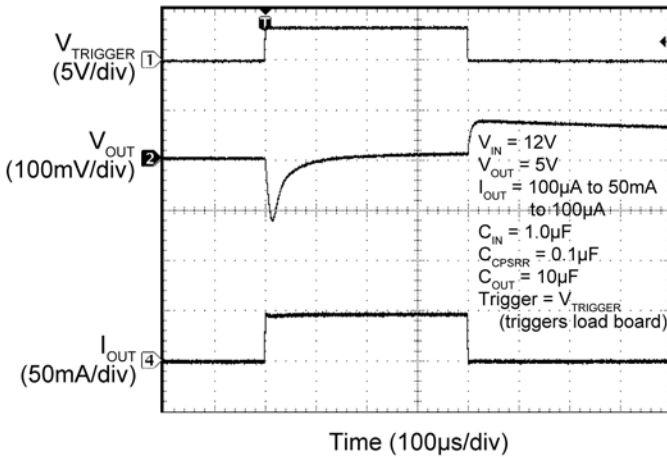

Line Transient Response

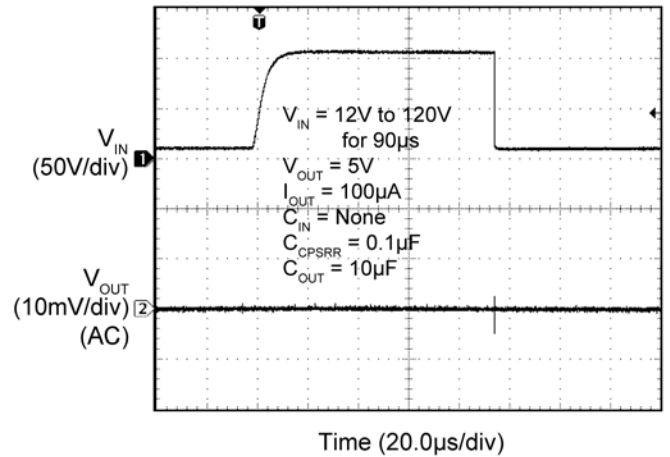

## Detailed Description

The MIC5282 voltage regulator accepts a 6V to 120V input and has an ultra-low 6 $\mu$ A typical quiescent current while offering an excellent line transient response and PSRR. These features make it ideal for harsh, noisy environments. All options of the device offer 50mA of output current. The MIC5282YMM and MIC5282YMME offer an adjustable output voltage from 1.27V to 5.5V. The MIC5282-3.3YMME and MIC5282-3.3YMM offer fixed 3.3V outputs and the MIC5282-5.0YMME and MIC5282-5.0YMM offer fixed 5.0V outputs. The YMME packaged devices feature a heat slug to more effectively remove heat from the die.

## Applications Information

### Thermal Protection

MIC5282 has internal thermal shutdown to protect it from excessive heating of the die. When the junction temperature exceeds approximately +155°C, the output is disabled and the device begins to cool down. The device turns back on when the junction temperature cools by 15°C. This will result in a cycled output during continuous thermal-overload conditions.

### Current Limit

MIC5282 features output current-limit protection. The output sustains a continuous short circuit to GND without damage to the device, but thermal shutdown often results.

### Input Capacitor

Connect a 1.0 $\mu$ F capacitor from VIN to GND. Micrel recommends the C5750X7R2E105M, 1.0 $\mu$ F, 250V capacitor made by TDK. When using a different capacitor, assure that the voltage rating of the capacitor exceeds any potential transient.

### CPSRR Capacitor

Connect a 0.1 $\mu$ F capacitor from CPSRR to GND to maintain high power supply rejection. The voltage rating of the capacitor must be at least 14V.

### Output Capacitor

Connect a 10 $\mu$ F capacitor from VOUT to GND. Assure that the voltage rating of the capacitor exceeds the designed output voltage of the MIC5282.

## Output Voltage Setting

For the MIC5282YMME and MIC5282YMM,  $V_{OUT}$  is programmed from 1.27V to 5.5V using:

$$V_{OUT} = V_{REF} \times \left( \frac{R1}{R2} + 1 \right)$$

where  $V_{REF} = 1.27V$ , and R1 and R2 are shown in the Typical Applications circuit.

## Thermal Measurements

It is always wise to measure an IC's case temperature to make sure that it is within operating limits, but it is easy to get erroneous results. The standard thermal couple that comes with many voltage meters uses a large wire gauge that behaves like a heat-sink, resulting in artificially low case temperature measurements. Use a thermocouple of 36-gauge wire or smaller, such as the Omega (5SC-TT-K-36-36), to minimize the heat-sinking effect. Also, apply thermal compound to maximize heat transfer between the IC and the thermocouple.

An infrared thermometer is a recommended alternative. The IR thermometer from Optris has a 1mm spot size, ideal for monitoring small surface mount packages. Also, the optional stand makes it easy to keep the beam on the IC for long periods of time.

# Functional Diagram

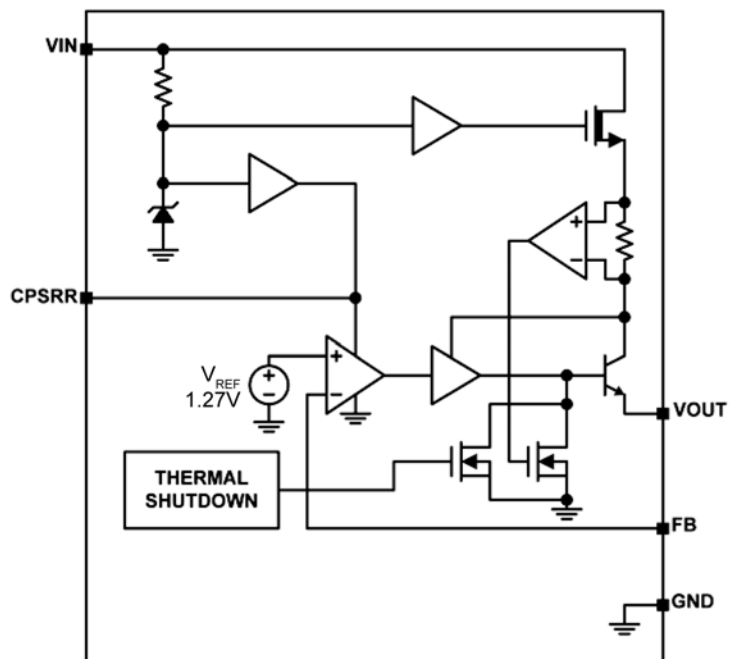

MIC5282 Adjustable Version

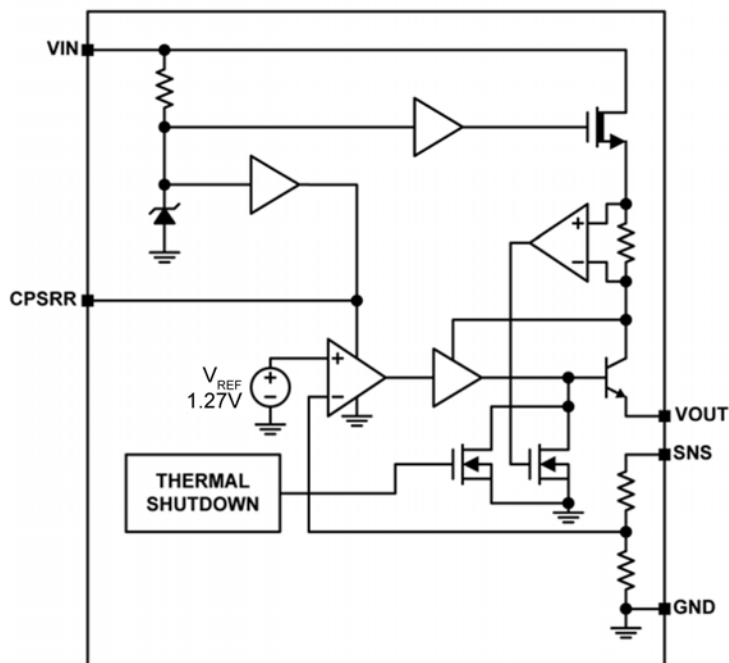

MIC5282 Fixed Version

### MIC5282 Evaluation Board Schematic

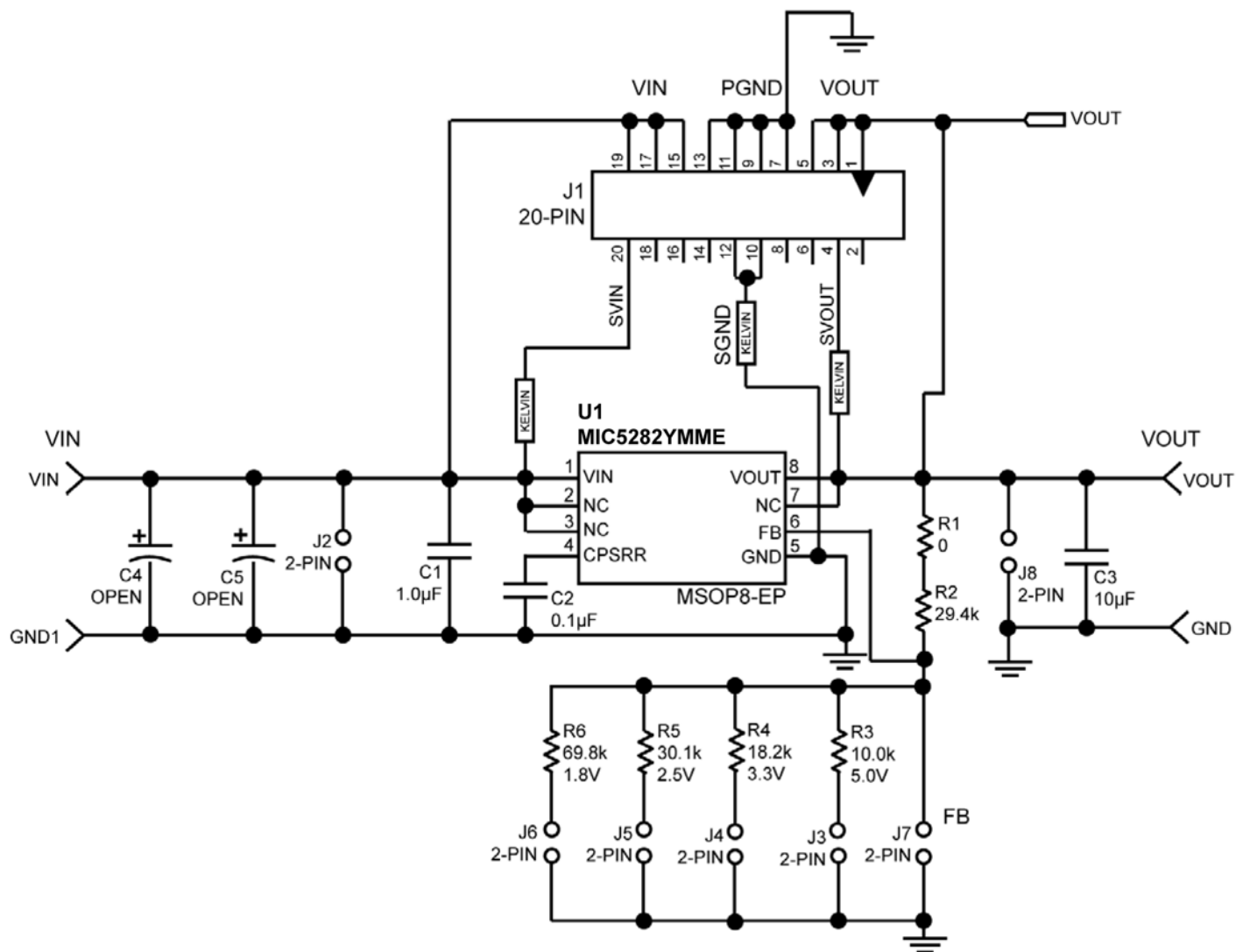

MIC5282 Evaluation Board Schematic

**Bill of Materials**

| Item      | Part Number        | Manufacturer                | Description                                                                                         | Qty.     |
|-----------|--------------------|-----------------------------|-----------------------------------------------------------------------------------------------------|----------|
| C1        | C5750X7R2E105M     | TDK <sup>(1)</sup>          | 1.0 $\mu$ F, 250V, 20%, X7R capacitor (2220)                                                        | 1        |
| C2        | 08053C104KAT2A     | AVX <sup>(2)</sup>          | 0.1 $\mu$ F 25V 20%, X7R capacitor (0805)                                                           | 1        |
| C3        | 0805ZD106KAT2A     | AVX                         | 10 $\mu$ F, 10V, 20%, X5R, capacitor (0805)                                                         | 1        |
| C4        | OPEN               | Panasonic <sup>(3)</sup>    | 100 $\mu$ F, 160V, 20% capacitor (ALU, 0.492" diameter can 0.197" lead spacing - Part # ECA-2CM101) | 0        |
| C5        | OPEN               | ANY                         | Capacitor                                                                                           | 0        |
| R1        | CRCW06030000F      | Vishay/Dale <sup>(4)</sup>  | 0 $\Omega$ , 1% resistor, 0603                                                                      | 1        |
| R2        | CRCW06032942F      | Vishay/Dale                 | 29.4k $\Omega$ , 1% resistor, 0603                                                                  | 1        |
| R3        | CRCW06031002F      | Vishay/Dale                 | 10.0k $\Omega$ , 1% resistor, 0603                                                                  | 1        |
| R4        | CRCW06031822F      | Vishay/Dale                 | 18.2k $\Omega$ , 1%, resistor, 0603                                                                 | 1        |
| R5        | CRCW06033012F      | Vishay/Dale                 | 30.1k $\Omega$ , 1% resistor chip, 0603                                                             | 1        |
| R6        | CRCW06036982F      | Vishay/Dale                 | 69.8k $\Omega$ , 1%, resistor, 0603                                                                 | 1        |
| <b>U1</b> | <b>MIC5282YMME</b> | <b>Micrel<sup>(5)</sup></b> | <b>120V<sub>IN</sub>, 50mA, Ultra-Low I<sub>Q</sub>, High-PSRR Linear Regulator</b>                 | <b>1</b> |

**Notes:**

1. TDK: [www.tdk.com](http://www.tdk.com).
2. AVX: [www.avx.com](http://www.avx.com).
3. Panasonic: [www.panasonic.com](http://www.panasonic.com).
4. Vishay Tel: [www.vishay.com](http://www.vishay.com).
5. **Micrel, Inc.:** [www.micrel.com](http://www.micrel.com).

# PCB Evaluation Board Layout

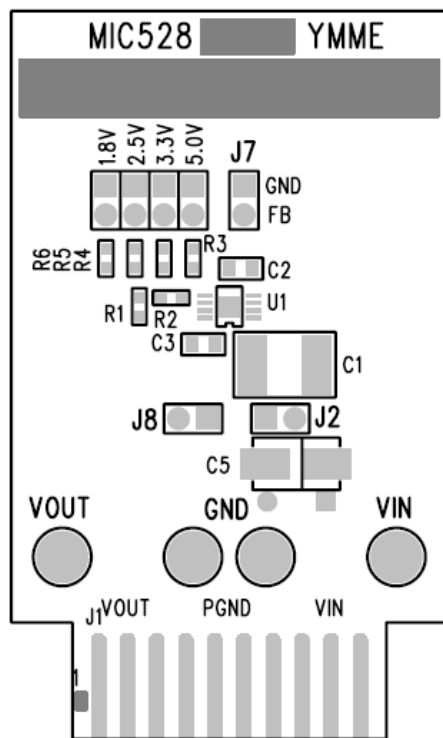

Top Layer Silk Screen

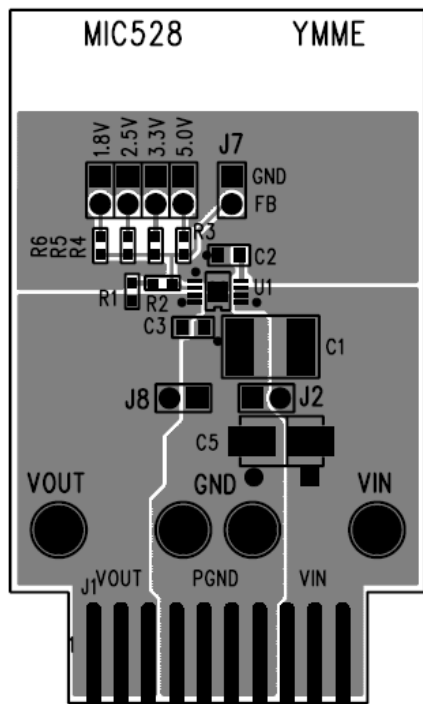

Top Layer Traces

### PCB Evaluation Board Layout (Continued)

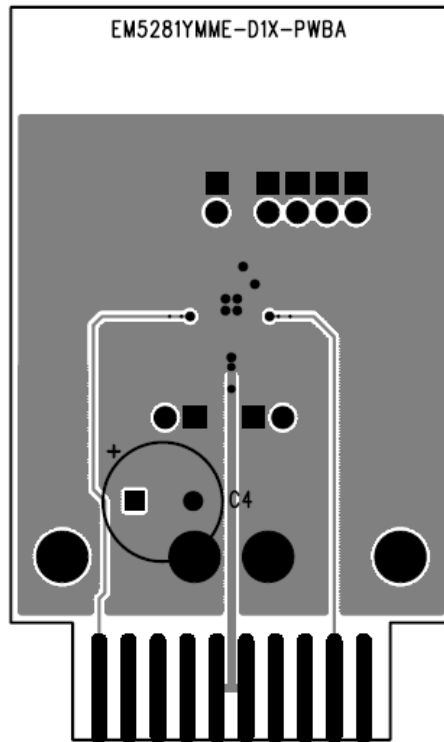

Bottom Layer Traces

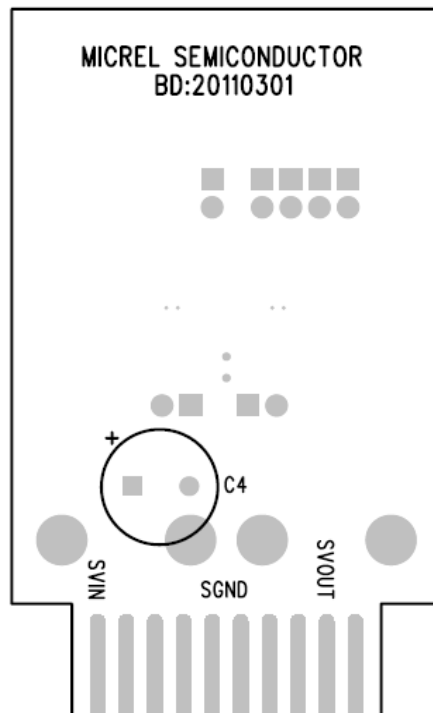

Bottom Layer Silk Screen

### PCB Evaluation Board Layout (Continued)

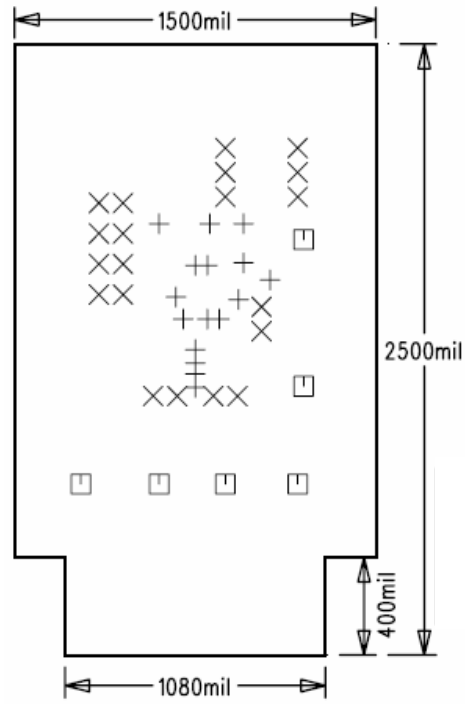

**EV Board Dimensions**



# Package Information and Recommended Landing Pattern<sup>(1)</sup>

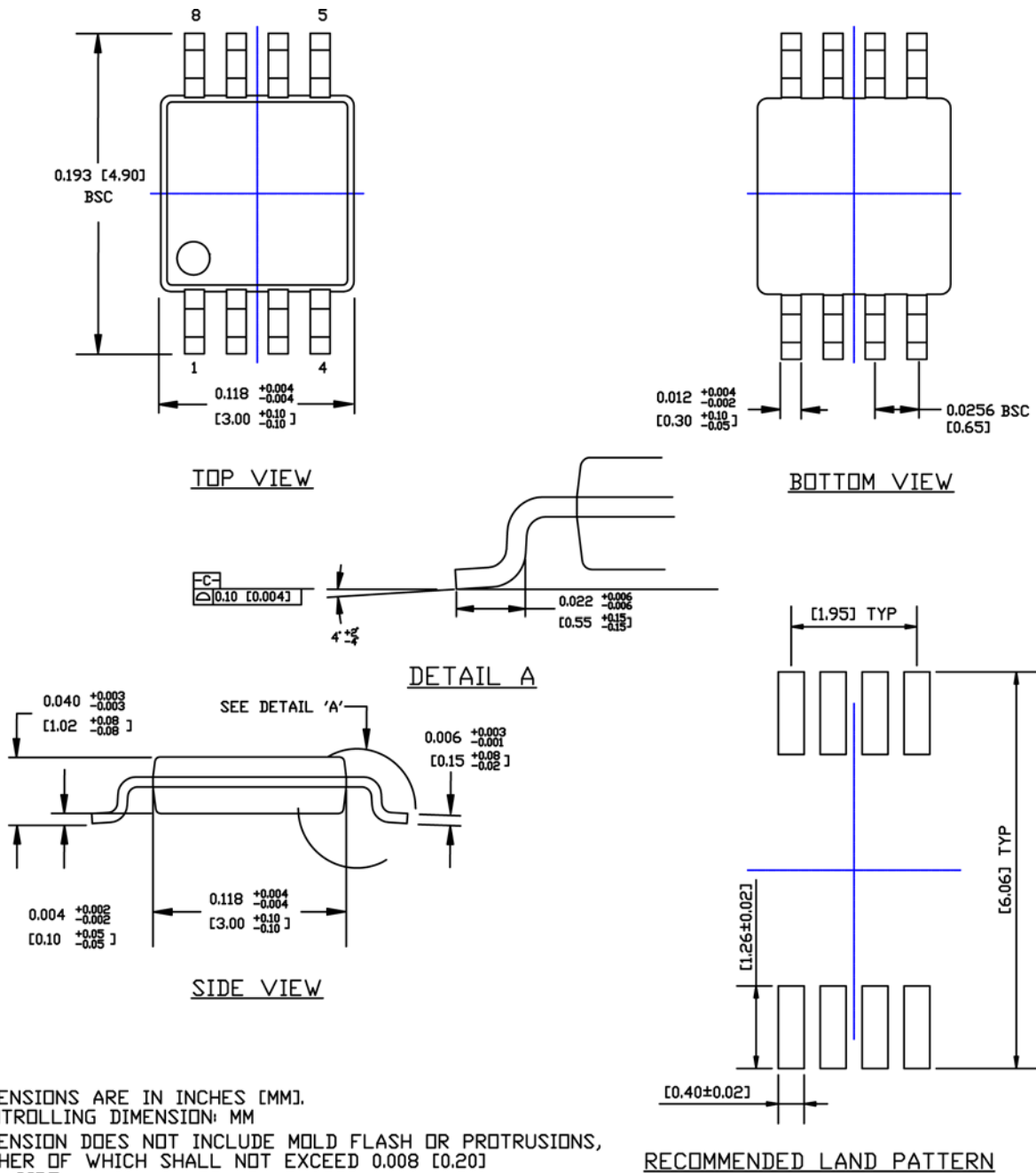

## 8-Pin MSOP

**Note:**

1. Package information is correct as of the publication date. For updates and most current information, go to [www.micrel.com](http://www.micrel.com).

Package Information and Recommended Landing Pattern<sup>(1)</sup> (Continued)

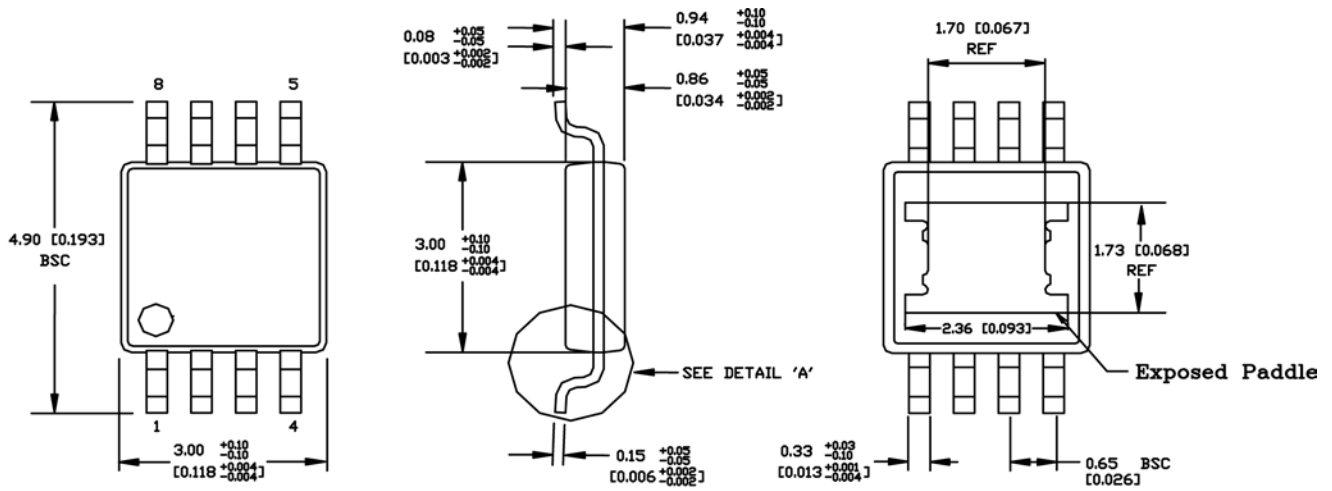

TOP VIEW

END VIEW

BOTTOM VIEW

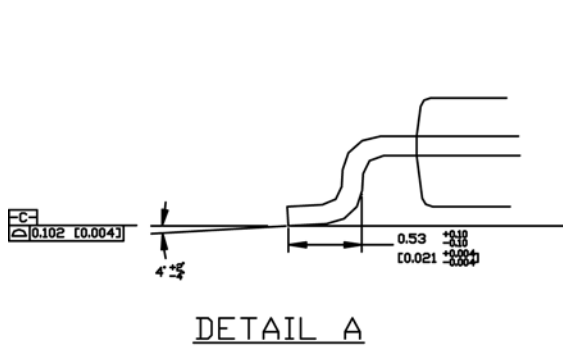

DETAIL A

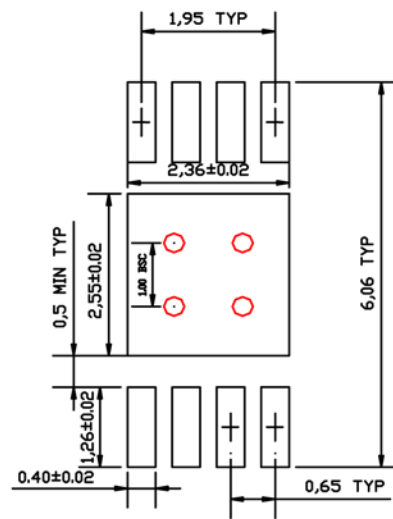

RECOMMENDED LAND PATTERN

NOTE:

1. DIMENSION DOES NOT INCLUDE MOLD FLASH OR PROTRUSIONS, EITHER OF WHICH SHALL NOT EXCEED 0.20 [0.008] PER SIDE
2. RED CIRCLES IN LAND PATTERN REPRESENT THERMAL VIAS. RECOMMENDED SIZE IS 0.30-0.35MM IN DIAMETER, 1.00 PITCH AND SHOULD BE CONNECTED TO GND FOR MAXIMUM PERFORMANCE

8-Pin Exposed Pad (ePad) MSOP

---

**MICREL, INC. 2180 FORTUNE DRIVE SAN JOSE, CA 95131 USA**  
TEL +1 (408) 944-0800 FAX +1 (408) 474-1000 WEB <http://www.micrel.com>

Micrel makes no representations or warranties with respect to the accuracy or completeness of the information furnished in this data sheet. This information is not intended as a warranty and Micrel does not assume responsibility for its use. Micrel reserves the right to change circuitry, specifications and descriptions at any time without notice. No license, whether express, implied, arising by estoppel or otherwise, to any intellectual property rights is granted by this document. Except as provided in Micrel's terms and conditions of sale for such products, Micrel assumes no liability whatsoever, and Micrel disclaims any express or implied warranty relating to the sale and/or use of Micrel products including liability or warranties relating to fitness for a particular purpose, merchantability, or infringement of any patent, copyright or other intellectual property right.

Micrel Products are not designed or authorized for use as components in life support appliances, devices or systems where malfunction of a product can reasonably be expected to result in personal injury. Life support devices or systems are devices or systems that (a) are intended for surgical implant into the body or (b) support or sustain life, and whose failure to perform can be reasonably expected to result in a significant injury to the user. A Purchaser's use or sale of Micrel Products for use in life support appliances, devices or systems is a Purchaser's own risk and Purchaser agrees to fully indemnify Micrel for any damages resulting from such use or sale.

© 2011 Micrel, Incorporated.