

# NJL6145L

New JRC NJL6145L is a side on type PIN photodiode with a visible light rejective epoxy dome which operate as a radiation collector at the same time. Big chip gives high sensitivity and small junction capacitance make it possible to operate at high frequency. These features meet applications such as remote controls of TVs, audio sets, air-conditioners, projectors and so on.

Most suitable combination for these applications is obtained by using NJL1120L or NJL1103L as an infrared emitter.

■ **Absolute Maximum Ratings** ( $T_a=25^\circ\text{C}$ )

Forward Current	$I_F$	100mA
Reverse Voltage	$V_R$	30V
Power Dissipation	$P_D$	150mW
Operating Temperature	$T_{opr}$	$-30^\circ\text{C}$ to $+90^\circ\text{C}$
Storage Temperature	$T_{stg}$	$-40^\circ\text{C}$ to $+100^\circ\text{C}$

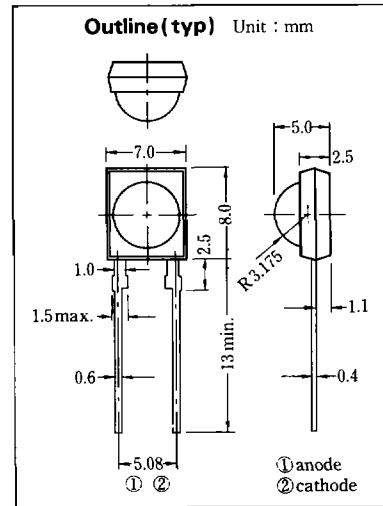

■ **Electro-Optical Characteristics** ( $T_a=25^\circ\text{C}$ )

Parameter	Symbol	Test Condition	Min.	Typ.	Max.	Unit
Dark Current	$I_D$	$V_R=10\text{V}$	—	—	50	nA
Sensitivity	S	$V_R=5\text{V}$ , $E_c=1\text{mW/cm}^2$	30	60	90	nA/lx
Capacitance	$C_{10}$	$V_R=0\text{V}$ , $f=1\text{MHz}$	—	70	—	pF
	$C_{13}$	$V_R=3\text{V}$ , $f=1\text{MHz}$	—	25	—	pF
Open-Circuit Voltage	$V_{oc}$	$E_c=100\text{lx}$ (note 1)	—	350	—	mV
Short-Circuit Current	$I_{sc}$	$E_c=100\text{lx}$ (note 1)	—	6	—	$\mu\text{A}$
Rise Time	$t_r$	$V_R=10\text{V}$ , $R_L=1\text{k}\Omega$ , $\lambda=940\text{nm}$	—	50	—	ns
Fall Time	$t_f$	$V_R=10\text{V}$ , $R_L=1\text{k}\Omega$ , $\lambda=940\text{nm}$	—	50	—	ns
Peak Wavelength	$\lambda_p$	$V_R=5\text{V}$	—	940	—	nm

(note 1) light source temperature 2854°K

## ■ Typical Characteristics

2

### Capacitance v.s. Reverse Voltage

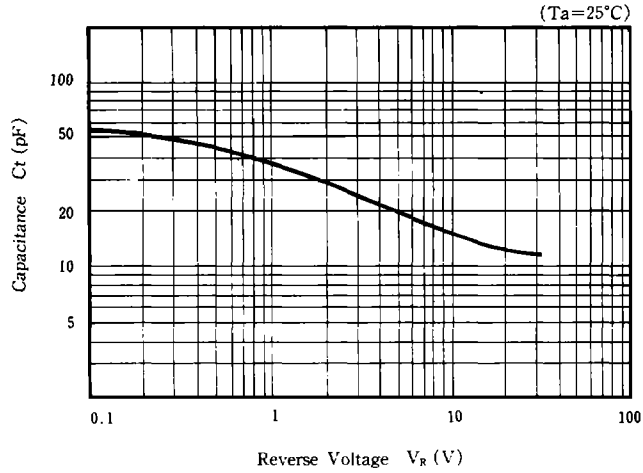

### Dark Current v.s. Temperature

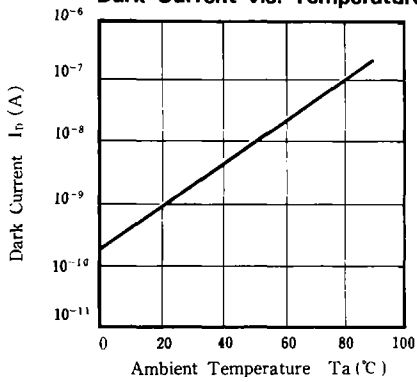

### Dark Current v.s. Reverse Voltage

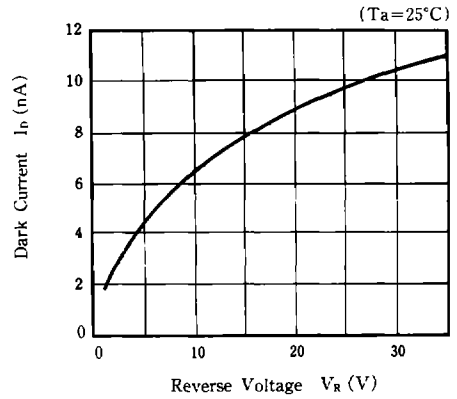

### Relative Angular Response ( $T_a = 25^\circ\text{C}$ )

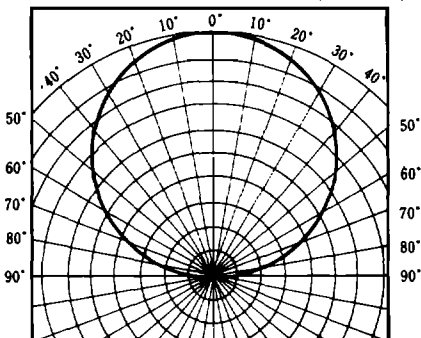

### Spectral Response ( $T_a = 25^\circ\text{C}$ )

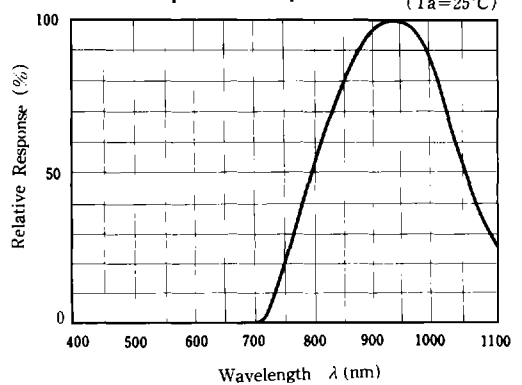

**Relative Sensitivity v.s. Temperature**

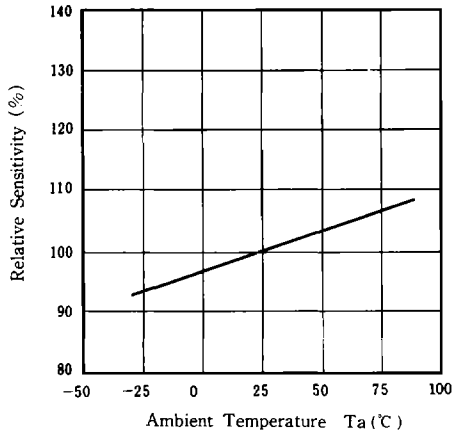

**Power Dissipation v.s. Temperature**

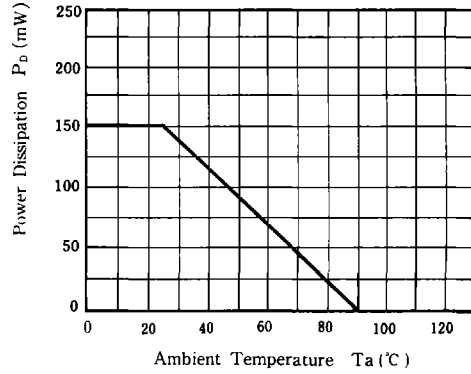

**Light Current v.s. Illuminance ( $T_a=25^\circ\text{C}$ )**

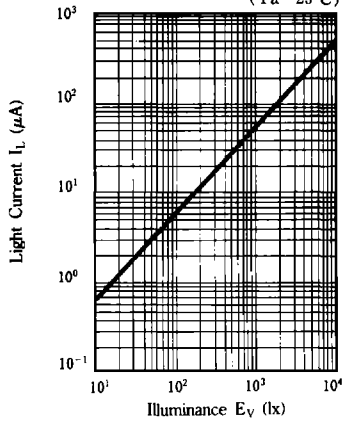

2