

2-WAY POWER DIVIDER

FLAT-PACK MODEL: DSF-105

WIDE BANDWIDTH

50 - 2000 MHz

FEATURES:

- ▶ Excellent Performance
- ▶ Wide Bandwidth
- ▶ Moderate Power

APPLICATIONS:

- ▶ Signal Splitting & Low Power Combining

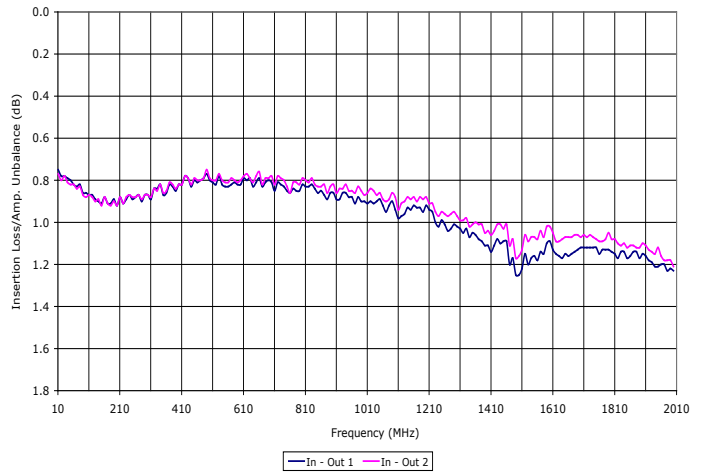
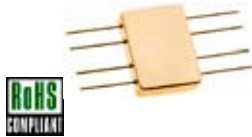

SPECIFICATIONS (Rev. A 10/26/10)

Frequency	10 - 2000 MHz		
Insertion Loss (dB) *	Freq. (MHz)	Typ.	Max.
	10 - 100	0.9	1.2
	100 - 1000	0.9	1.5
	1000 - 2000	1.2	1.7
Isolation (dB)	Freq. (MHz)	Typ.	Min.
	10 - 100	25	20
	100 - 1000	23	18
	1000 - 2000	23	18
Phase Unbalance	Freq. (MHz)	Typ.	Max.
	10 - 100	0.1°	2.0°
	100 - 1000	0.5°	4.0°
	1000 - 2000	1.5°	6.0°
Amplitude Unbalance (dB)	Freq. (MHz)	Typ.	Max.
	10 - 100	0.01	0.2
	100 - 1000	0.04	0.4
	1000 - 2000	0.10	0.6
Input Power **	3 Watt (Max.)		
VSWR	Input	Output	
	1.28:1 (Typ.)	1.28:1 (Typ.)	
Impedance	50 Ohms (Nom.)		
Operating Temperature Range	-55 to +85 °C		
* Above 3.0 dB theoretical split loss.			
** Handling power applies to splitter mode and assumes ideal 50 Ohms impedance matching on all ports.			

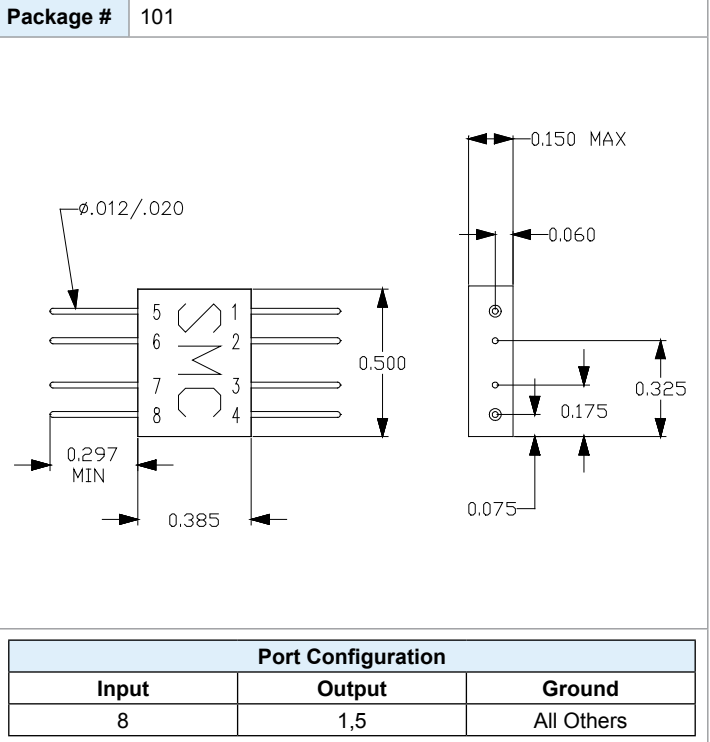

2-WAY POWER DIVIDER

FLAT-PACK MODEL: DSF-105

WIDE BANDWIDTH

50 - 2000 MHz

Data @ 25°C

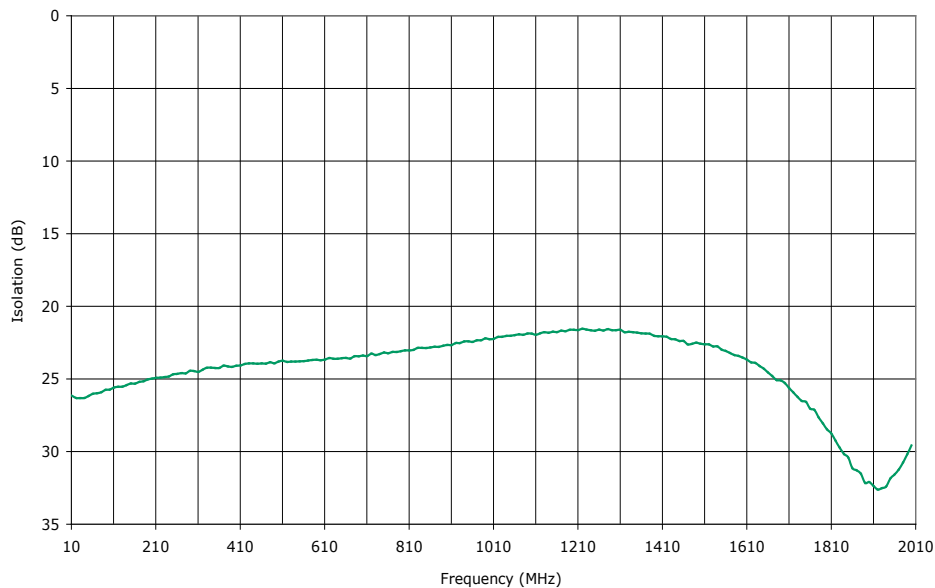
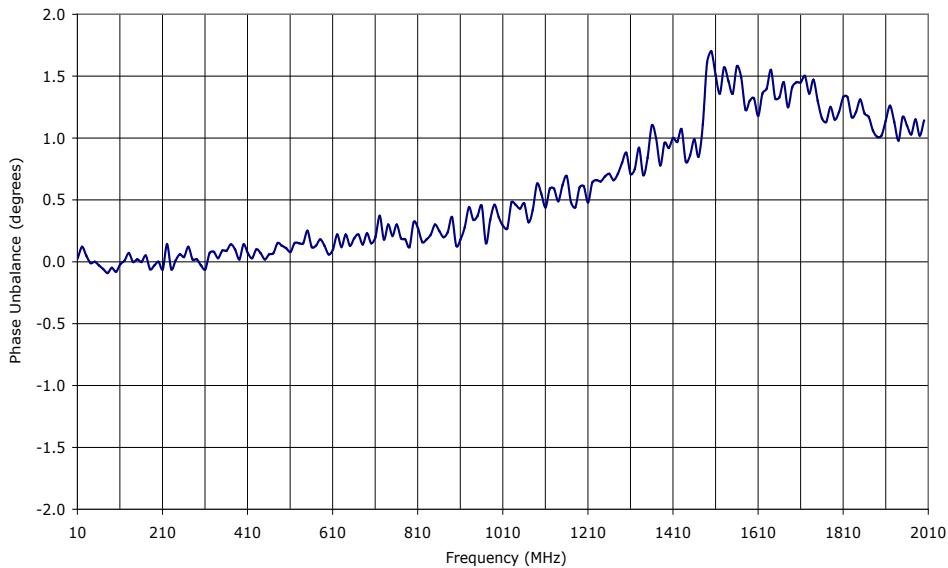

PERFORMANCE PLOTS

2-WAY POWER DIVIDER

FLAT-PACK MODEL: DSF-105

WIDE BANDWIDTH

50 - 2000 MHz

Data @ 25°C

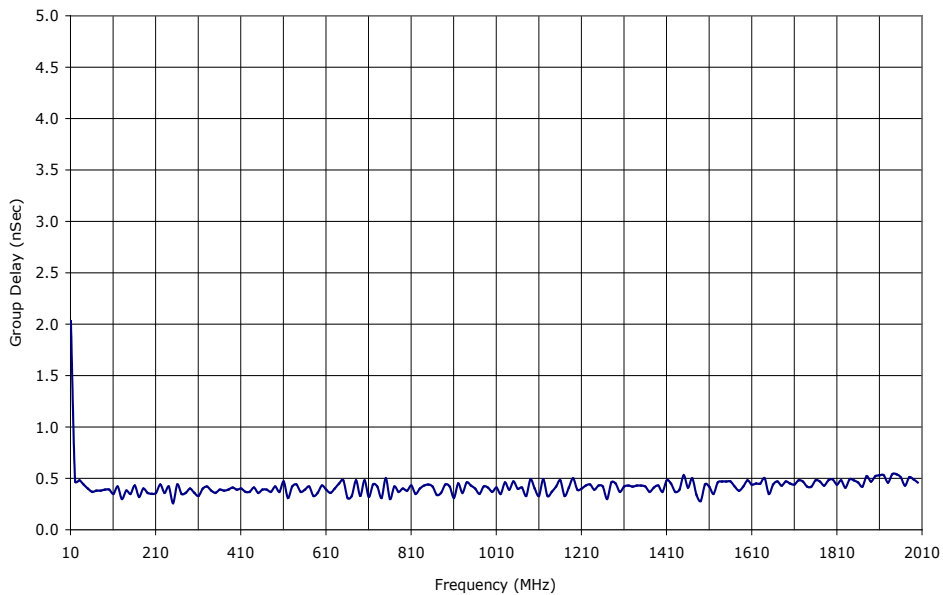
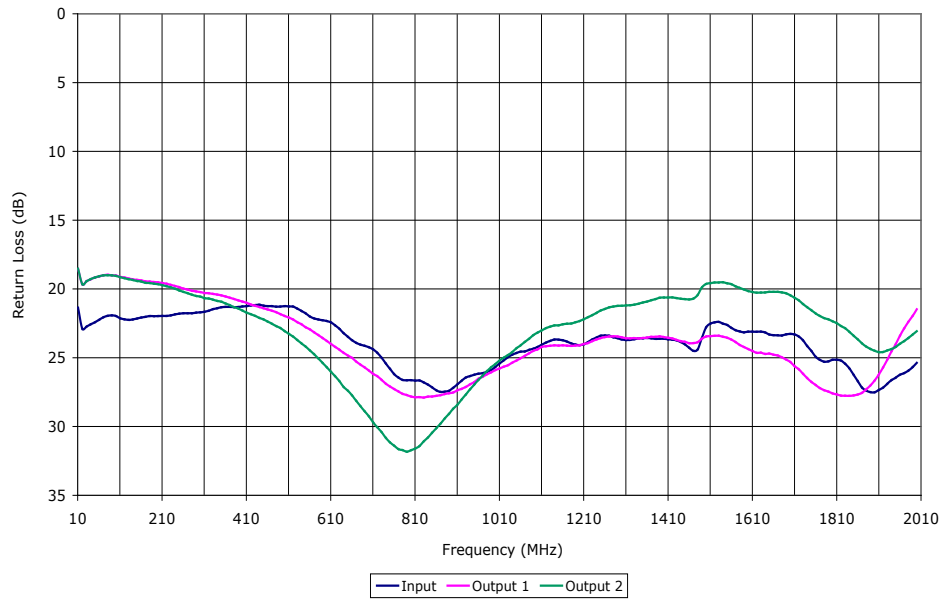

PERFORMANCE PLOTS