

## Clock Display

### Description

Four digit Display, with 10 mm digit charactersize. Designed as clock Display with active colon between digit two and three.

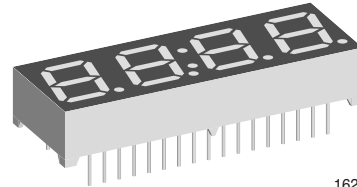

16294

### Features

- High efficient AlInGAP technology
- Dark surface, white segments
- Common anode  
(TDCG1050, TDCR1050, TDCY1050)
- Common cathode  
(TDCG1060, TDCR1060, TDCY1060)
- Recommended viewing distance up to 7 meter
- Lead-free device

### Applications

Clock modules for Video/Audioequipment, Instrumentation, Set Top Boxes

### Parts Table

Part	Color, Luminous Intensity	Circuitry
TDCG1050	Green, $I_V = (2.8 \text{ to } 4.0) \text{ mcd}$	Common anode
TDCG1060	Green, $I_V = (2.8 \text{ to } 4.0) \text{ mcd}$	Common cathode
TDCR1050	Red, $I_V = (4.0 \text{ to } 6.0) \text{ mcd}$	Common anode
TDCR1060	Red, $I_V = (4.0 \text{ to } 6.0) \text{ mcd}$	Common cathode
TDCY1050	Super Yellow, $I_V = (4.0 \text{ to } 6.0) \text{ mcd}$	Common anode
TDCY1060	Super Yellow, $I_V = (4.0 \text{ to } 6.0) \text{ mcd}$	Common cathode

### Absolute Maximum Ratings

$T_{amb} = 25^\circ\text{C}$ , unless otherwise specified

**TDCG1050/ TDCG1060, TDCR1050/ TDCR1060, TDCY1050/ TDCY1060,**

Parameter	Test condition	Symbol	Value	Unit
Reverse voltage		$V_R$	5	V
Forward current		$I_F$	25	mA
Operating temperature range		$T_{amb}$	-40 to + 85	$^\circ\text{C}$
Storage temperature range		$T_{stg}$	-40 to + 100	$^\circ\text{C}$
Soldering temperature		$T_{sd}$	$260 \pm 5$	$^\circ\text{C}$
Electrostatic discharge		ESD	2000	V
Power dissipation		$P_V$	60	mW
Peak forward current	(Duty 1/10 @ 1kHz)	$I_F(\text{Peak})$	160	mA

### Optical and Electrical Characteristics

$T_{amb} = 25\text{ }^{\circ}\text{C}$ , unless otherwise specified

#### Red

##### TDCR1050/TDCR1060

Parameter	Test condition	Part	Symbol	Min	Typ.	Max	Unit
Luminous intensity per segment <sup>1)</sup>	$I_F = 2\text{ mA}$	TDCR1050	$I_V$		1.5		mcd
		TDCR1060	$I_V$		1.5		mcd
	$I_F = 10\text{ mA}$	TDCR1050	$I_V$	4.0	6.0		mcd
		TDCR1060	$I_V$	4.0	6.0		mcd
Luminous intensity of colon	$I_F = 2\text{ mA}$	TDCR1050	$I_V$		0.4		mcd
		TDCR1060	$I_V$		0.4		mcd
	$I_F = 10\text{ mA}$	TDCR1050	$I_V$	0.5	0.8		mcd
		TDCR1060	$I_V$	0.5	0.8		mcd
Dominant wavelength	$I_F = 20\text{ mA}$		$\lambda_d$		631		nm
Peak wavelength	$I_F = 20\text{ mA}$		$\lambda_p$		639		nm
Spectral bandwidth	$I_F = 20\text{ mA}$		$\Delta\lambda$		20		nm
Forward voltage	$I_F = 20\text{ mA}$		$V_F$		2.0	2.4	V
Reverse current	$V_R = 5\text{ V}$		$I_R$			10	$\mu\text{A}$

Note<sup>1)</sup>  $I_{Vmin}$  and  $I_V$  groups are mean values of all segments (a to g, D1 to D4), matching factor within segments is  $\geq 0.5$ , excluding decimal points and colon.

#### Yellow

##### TDCY1050/TDCY1060

Parameter	Test condition	Part	Symbol	Min	Typ.	Max	Unit
Luminous intensity per segment <sup>1)</sup>	$I_F = 2\text{ mA}$	TDCY1050	$I_V$		1.5		mcd
		TDCY1060	$I_V$		1.5		mcd
	$I_F = 10\text{ mA}$	TDCY1050	$I_V$	4.0	6.0		mcd
		TDCY1060	$I_V$	4.0	6.0		mcd
Luminous intensity of colon	$I_F = 2\text{ mA}$	TDCY1050	$I_V$		0.4		mcd
		TDCY1060	$I_V$		0.4		mcd
	$I_F = 10\text{ mA}$	TDCY1050	$I_V$	0.5	0.8		mcd
		TDCY1060	$I_V$	0.5	0.8		mcd
Dominant wavelength	$I_F = 20\text{ mA}$		$\lambda_d$		589		nm
Peak wavelength	$I_F = 20\text{ mA}$		$\lambda_p$		591		nm
Spectral bandwidth	$I_F = 20\text{ mA}$		$\Delta\lambda$		15		nm
Forward voltage	$I_F = 20\text{ mA}$		$V_F$		2.0	2.4	V
Reverse current	$V_R = 5\text{ V}$		$I_R$			10	$\mu\text{A}$

Note<sup>1)</sup>  $I_{Vmin}$  and  $I_V$  groups are mean values of all segments (a to g, D1 to D4), matching factor within segments is  $\geq 0.5$ , excluding decimal points and colon.

## Green

### TDCG1050/TDCG1060

Parameter	Test condition	Part	Symbol	Min	Typ.	Max	Unit
Luminous intensity per segment <sup>1)</sup>	$I_F = 2 \text{ mA}$	TDCG1050	$I_V$		1.0		mcd
		TDCG1060	$I_V$		1.0		mcd
	$I_F = 10 \text{ mA}$	TDCG1050	$I_V$	2.8	4.0		mcd
		TDCG1060	$I_V$	2.8	4.0		mcd
Luminous intensity of colon	$I_F = 2 \text{ mA}$	TDCG1050	$I_V$		0.2		mcd
		TDCG1060	$I_V$		0.2		mcd
	$I_F = 10 \text{ mA}$	TDCG1050	$I_V$	0.5	1.2		mcd
		TDCG1060	$I_V$	0.5	1.2		mcd
Dominant wavelength	$I_F = 20 \text{ mA}$		$\lambda_d$		573		nm
Peak wavelength	$I_F = 20 \text{ mA}$		$\lambda_p$		575		nm
Spectral bandwidth	$I_F = 20 \text{ mA}$		$\Delta\lambda$		20		nm
Forward voltage	$I_F = 20 \text{ mA}$		$V_F$		2.0	2.4	V
Reverse current	$V_R = 5 \text{ V}$		$I_R$			10	$\mu\text{A}$

Note<sup>1)</sup>  $I_{Vmin}$  and  $I_V$  groups are mean values of all segments (a to g, D1 to D4), matching factor within segments is  $\geq 0.5$ , excluding decimal points and colon.

### Typical Characteristics ( $T_{amb} = 25 \text{ }^\circ\text{C}$ unless otherwise specified)

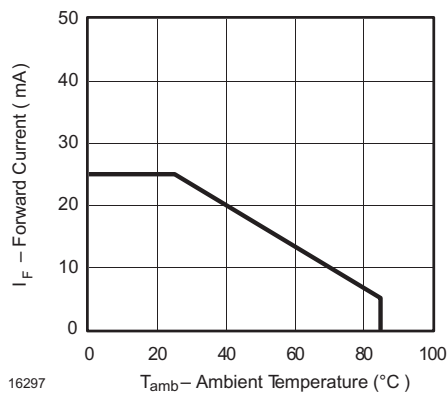

Figure 1. Forward Current vs. Ambient Temperature

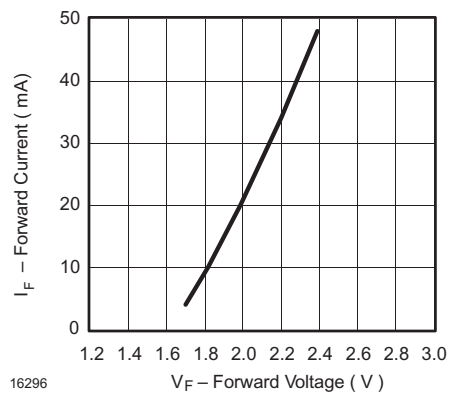

Figure 2. Forward Current vs. Forward Voltage

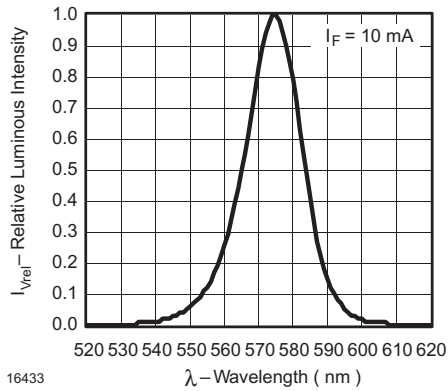

Figure 3. Relative Intensity vs. Wavelength

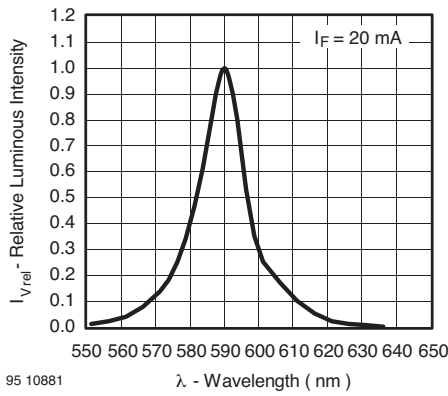

Figure 4. Relative Intensity vs. Wavelength

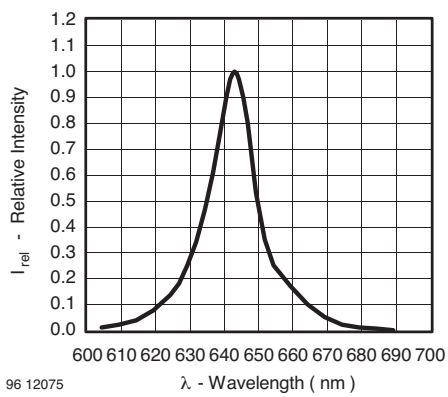
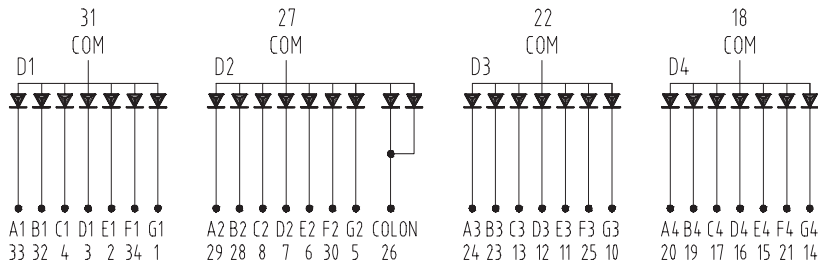
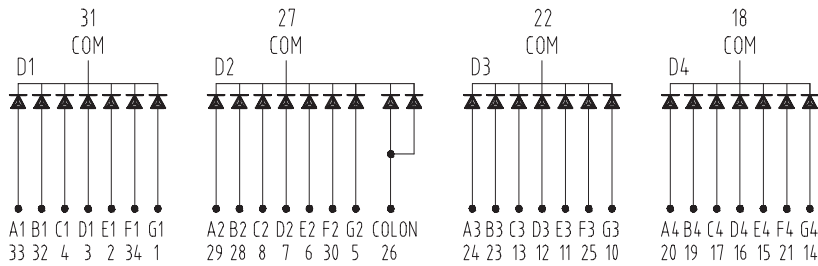

Figure 5. Relative Intensity vs. Wavelength



Common Anode

- |                 |                    |                     |
|-----------------|--------------------|---------------------|
| 1 Cathode D1 G  | 13 Cathode D3 C    | 25 Cathode D3 F     |
| 2 Cathode D1 E  | 14 Cathode D4 G    | 26 Cathode D2 Colon |
| 3 Cathode D1 D  | 15 Cathode D4 E    | 27 Common Anode D2  |
| 4 Cathode D1 C  | 16 Cathode D4 D    | 28 Cathode D2 B     |
| 5 Cathode D2 G  | 17 Cathode D4 C    | 29 Cathode D2 A     |
| 6 Cathode D2 E  | 18 Common Anode D4 | 30 Cathode D2 F     |
| 7 Cathode D2 D  | 19 Cathode D4 B    | 31 Common Anode D1  |
| 8 Cathode D2 C  | 20 Cathode D4 A    | 32 Cathode D1 B     |
| 9 no Pin        | 21 Cathode D4 F    | 33 Cathode D1 A     |
| 10 Cathode D3 G | 22 Common Anode D3 | 34 Cathode D1 F     |
| 11 Cathode D3 E | 23 Cathode D3 B    |                     |
| 12 Cathode D3 D | 24 Cathode D3 A    |                     |



Common Cathode

- |               |                      |                      |
|---------------|----------------------|----------------------|
| 1 Anode D1 G  | 13 Anode D3 C        | 25 Anode D3 F        |
| 2 Anode D1 E  | 14 Anode D4 G        | 26 Anode D2 Colon    |
| 3 Anode D1 D  | 15 Anode D4 E        | 27 Common Cathode D2 |
| 4 Anode D1 C  | 16 Anode D4 D        | 28 Anode D2 B        |
| 5 Anode D2 G  | 17 Anode D4 C        | 29 Anode D2 A        |
| 6 Anode D2 E  | 18 Common Cathode D4 | 30 Anode D2 F        |
| 7 Anode D2 D  | 19 Anode D4 B        | 31 Common Cathode D1 |
| 8 Anode D2 C  | 20 Anode D4 A        | 32 Anode D1 B        |
| 9 no Pin      | 21 Anode D4 F        | 33 Anode D1 A        |
| 10 Anode D3 G | 22 Common Cathode D3 | 34 Anode D1 F        |
| 11 Anode D3 E | 23 Anode D3 B        |                      |
| 12 Anode D3 D | 24 Anode D3 A        |                      |

Drawing-No.: 6.544-5334.01-4 Bl. 2  
Issue: 1; 20.02.02

16714

### Package Dimensions in mm

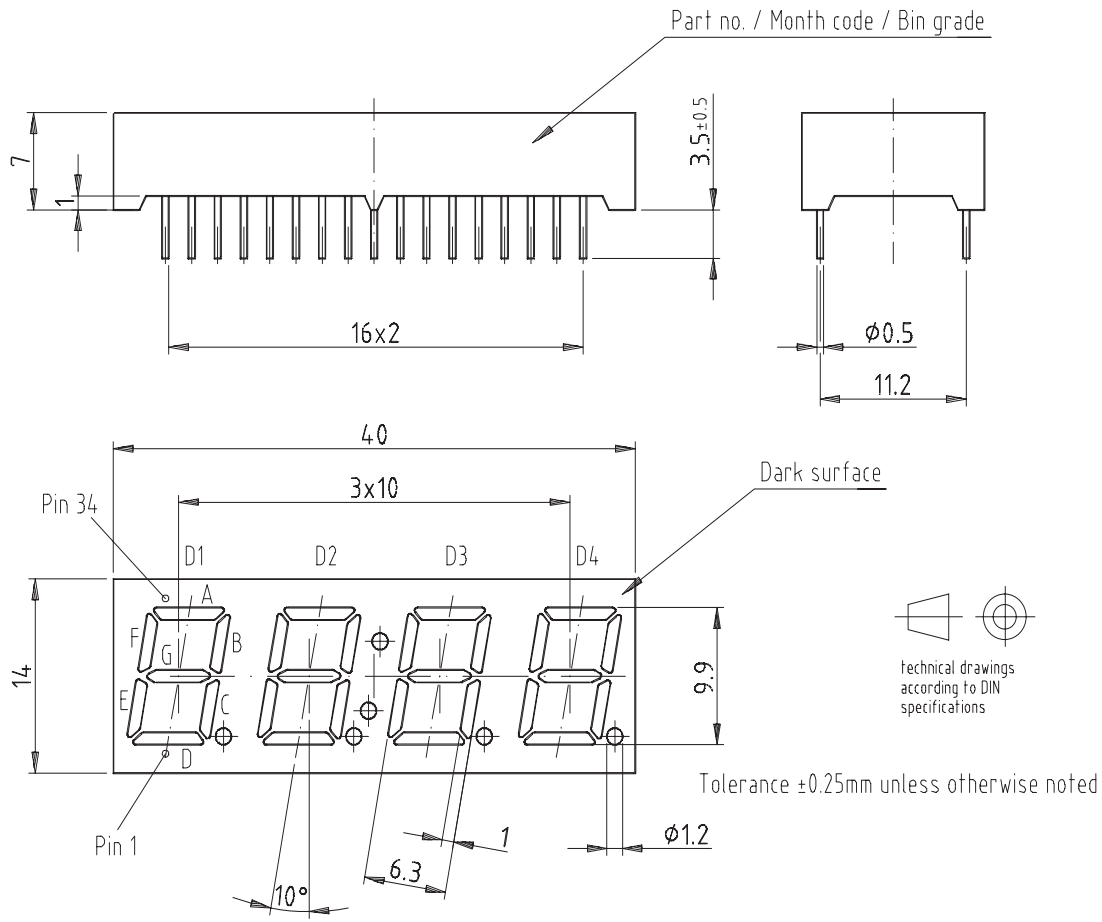

Drawing-No.: 6.544-5334.01-4 Bl. 1  
 Issue: 4; 27.02.02



## **Ozone Depleting Substances Policy Statement**

It is the policy of **Vishay Semiconductor GmbH** to

1. Meet all present and future national and international statutory requirements.
2. Regularly and continuously improve the performance of our products, processes, distribution and operating systems with respect to their impact on the health and safety of our employees and the public, as well as their impact on the environment.

It is particular concern to control or eliminate releases of those substances into the atmosphere which are known as ozone depleting substances (ODSs).

The Montreal Protocol (1987) and its London Amendments (1990) intend to severely restrict the use of ODSs and forbid their use within the next ten years. Various national and international initiatives are pressing for an earlier ban on these substances.

**Vishay Semiconductor GmbH** has been able to use its policy of continuous improvements to eliminate the use of ODSs listed in the following documents.

1. Annex A, B and list of transitional substances of the Montreal Protocol and the London Amendments respectively
2. Class I and II ozone depleting substances in the Clean Air Act Amendments of 1990 by the Environmental Protection Agency (EPA) in the USA
3. Council Decision 88/540/EEC and 91/690/EEC Annex A, B and C (transitional substances) respectively.

**Vishay Semiconductor GmbH** can certify that our semiconductors are not manufactured with ozone depleting substances and do not contain such substances.

### **We reserve the right to make changes to improve technical design and may do so without further notice.**

Parameters can vary in different applications. All operating parameters must be validated for each customer application by the customer. Should the buyer use Vishay Semiconductors products for any unintended or unauthorized application, the buyer shall indemnify Vishay Semiconductors against all claims, costs, damages, and expenses, arising out of, directly or indirectly, any claim of personal damage, injury or death associated with such unintended or unauthorized use.

Vishay Semiconductor GmbH, P.O.B. 3535, D-74025 Heilbronn, Germany  
Telephone: 49 (0)7131 67 2831, Fax number: 49 (0)7131 67 2423



## Disclaimer

All product specifications and data are subject to change without notice.

Vishay Intertechnology, Inc., its affiliates, agents, and employees, and all persons acting on its or their behalf (collectively, "Vishay"), disclaim any and all liability for any errors, inaccuracies or incompleteness contained herein or in any other disclosure relating to any product.

Vishay disclaims any and all liability arising out of the use or application of any product described herein or of any information provided herein to the maximum extent permitted by law. The product specifications do not expand or otherwise modify Vishay's terms and conditions of purchase, including but not limited to the warranty expressed therein, which apply to these products.

No license, express or implied, by estoppel or otherwise, to any intellectual property rights is granted by this document or by any conduct of Vishay.

The products shown herein are not designed for use in medical, life-saving, or life-sustaining applications unless otherwise expressly indicated. Customers using or selling Vishay products not expressly indicated for use in such applications do so entirely at their own risk and agree to fully indemnify Vishay for any damages arising or resulting from such use or sale. Please contact authorized Vishay personnel to obtain written terms and conditions regarding products designed for such applications.

Product names and markings noted herein may be trademarks of their respective owners.