

Umgebungslicht und Näherungssensor
Ambient Light and Proximity Sensor
Lead (Pb) Free Product - RoHS Compliant

SFH 7770



not for new design in industrial and automotive application

Wesentliche Merkmale

- Näherungssensor
 - Detektionsbereich bis 100mm
 - Gestenerkennung
 - Ausgänge zum Betrieb von bis zu drei IR Emittern
 - Optimiert für 850nm Emitter
 - Umgebungslicht-Unterdrückung
- Umgebungslichtsensor
 - 3lx - 65000lx
 - Gute Linearität
 - Spektrale Empfindlichkeit ähnlich dem menschlichen Auge
- I²C interface
 - 100kHz / 400kHz und 3.4MHz Mode
 - verschiedene Messmoden programmierbar (STAND-BY, TRIGGERED, FREE-RUNNING)
- < 5 µA Stromverbrauch im STAND-BY
- Geringe Abmessungen, 2.8 x 2.8 x 0.9 mm³

Features

- Proximity Sensor (PS)
 - Detection-range up to 100mm
 - Gesture recognition possible
 - Outputs to drive up to three IR emitters
 - Optimized for 850nm emitters
 - Suppression of ambient light
- Ambient Light Sensor (ALS)
 - 3lx - 65000lx
 - High linearity
 - Spectral sensitivity well matched to the human eye
- I²C interface
 - 100kHz / 400kHz and 3.4MHz mode
 - Measurement modes programmable (STAND-BY, TRIGGERED, FREE-RUNNING)
- Current consumption < 5µA in STAND-BY
- Small package size, 2.8 x 2.8 x 0.9 mm³

Anwendungen

- Mobiltelefone
- PDA's und Notebooks
- Kameras
- Consumer Produkte

Applications

- Mobile phones
- PDAs and notebooks
- Cameras
- Consumer products

Typ Type	Bestellnummer Ordering Code
SFH 7770	Q65110A9565

Application diagram and basic informations



- **The inductivity of the wire from the LED pin (1,2 or 3) to the cathode of the LED needs to be <math><20\text{nH}</math> at The cable length may be increased for lower currents inversely proportional to forward current: cable length $\sim 1/\text{forward current}$ (e.g. max 8 - 12cm at $I_f=50\text{mA}$).**
- Proposed size for the pull-up resistor is 560 Ohm
- Short evaluation program

Address	Command	Action
0x80	Write 03	Ambient Light Sensor in FREE-RUNNING mode
0x81	Write 03	Proximity Sensor in FREE-RUNNING mode
Wait 110 ms		
0x8C	Read data	read LSByte data from ambient light measurement
0x8D	Read data	read MSByte data from ambient light measurement
0x8F	Read data	read data from proximity measurement LED 1

I²C interface

- 1.8V IO-logic level for SDA and SCL
- I/O-pins are open drain type and logic high level is set with external pull-up resistor
- SFH 7770 operates always as slave, address is 0x38.
- Designed for the I²C-modes: Standard (100kHz), Fast (400kHz) and High Speed (3.4MHz)
- Combined format (see I²C Bus specification UM10204 from NXP) for data reading
- Block READ and WRITE modes are available. In these modes several registers can be read or written during single I²C traffic period. The register values are provided in a cyclic manner until master sends the stop condition. E.g. if master uses block read and starts from register 0x8C, the slave returns following register values: 0x8C, 0x8D, 0x8E, 0x8F, 0x90, 0x91, 0x92, 0x93, 0x94 and so on until the master sends stop condition.
- Interrupt pin (INT): open-drain output (like SDA and SCL)

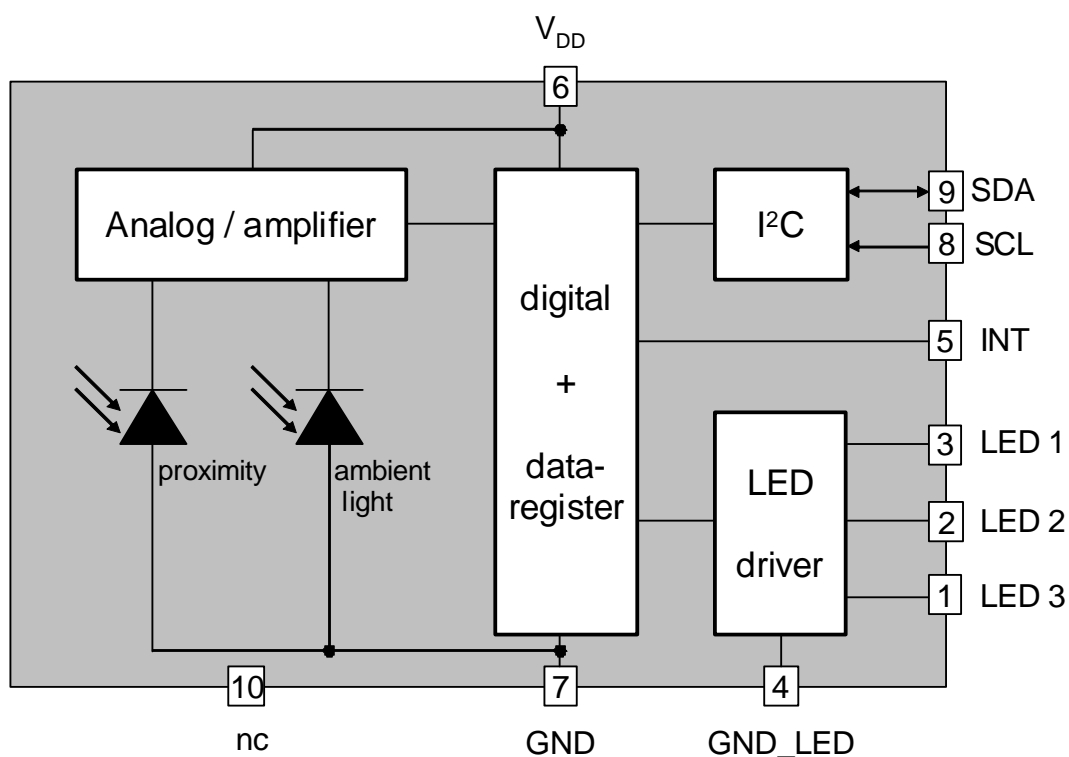

Measurement modes

OFF	I_{DD} is below $2\mu\text{A}$ and the device is inactive. Other units may use the I ² C bus without any restrictions; I/O pins and INT are in a high Z state. There is no sink current through the LEDs.
STAND-BY	This is the initial mode after power-up. I_{DD} is below $5\mu\text{A}$. No measurement is performed. Device can be activated by I ² C bus communication. Data registers can be read and written. The data will be stored in the registers when the device goes from TRIGGERED or FREE-RUNNING to STAND-BY.
TRIGGERED	Every measurement is separately initiated by MCU. This mode can be used for Ambient Light Sensor and Proximity Sensor. Measurement data are available in the registers after a defined delay time.
FREE-RUNNING	Measurements are triggered internally by SFH7770. This mode can also be used for Ambient Light Sensor and Proximity Sensor. Measurement repetition rate and current through the LEDs are defined by the MCU. Measurement results can be read from the data register, the status from the interrupt register.

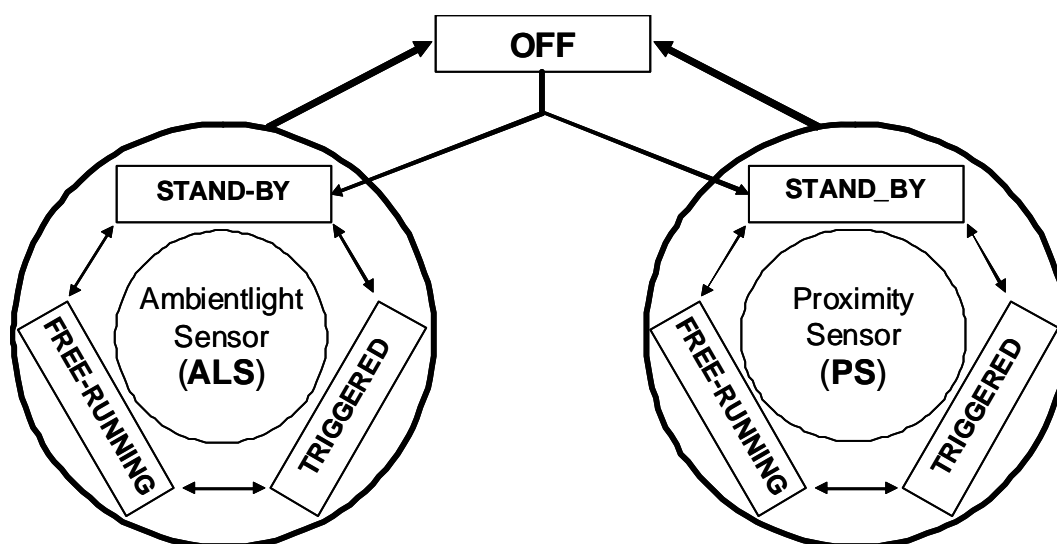

If V_{DD} exceeds the threshold-voltage, the sensor will switch from OFF to STAND-BY mode. As shown in the transition diagram above it is possible to switch between all modes without any restriction. The transition time between modes (t_{trans}) is $< 10\text{ms}$. The delay time between STAND-BY and start of measurement is max. 10ms for the Ambient Light Sensor.

Maximum limits

Parameter	Symbol	Value			Unit
		min.	typ.	max.	
Storage temperature	T_{stg}	- 40		+ 85	°C
Supply voltage (between V_{DD} and GND)	V_{DD}	- 0.3		+ 4.5	V
Maximum Voltage of SDA, SCL and INT to GND	V_{dig}	- 0.3		+ 3.6	V
Maximum Voltage of LED1 ... LED3 to GND_LED	V_{LED}	- 0.3		+ 5.5	V
Maximum Voltage between GND and GND_LED	V_{LED}	-500		+500	mV
Electrostatic discharge - Human Body Model (according to JESD22-A114-E; Class2)	ESD	2			kV

Operating conditions

Parameter	Symbol	Value			Unit
		min.	typ.	max.	
Operation temperature	T_{op}	- 20		+ 85	°C
Supply Voltage	V_{DD}	2.3		3.1	V
Ripple on Supply Voltage ($V_{DD} = 2.35 - 3.05V$, DC ... 100MHz)	$V_{DD,rip}$			10	mV
Voltage for I/O (SDA, SCL, INT) ¹⁾	V_{IO}	1.6		2.0	V
extended Voltage range for I/O (SDA, SCL, INT) ²⁾	$V_{IO,ext}$	1.6		3.1	V
Supply Voltage LED	V_{LED}	2.3		4.25	V
Ripple V_{LED}	$V_{LED,rip}$			500 200	mV mV
					DC... 30kHz 30kHz ... 100MHz

¹⁾ The limits for the logic levels of SCL and SDA pins are in accordance with the I²C bus specification from NXP (UM10204 „I²C bus specification and user manual“, Rev. 03 - 19 June 2007). The same limits are valid for the logic levels of the interrupt pin (INT): the maximum level for logic „LOW“ level is 30% of the I/O voltage V_{IO} , the minimum level for logic „HIGH“ level is 70% of the I/O voltage V_{IO} .

²⁾ Extended voltage range for I²C bus communication is only valid for standard- and fast-mode. Input levels are internally referenced to 1.8V. So „LOW“ level threshold is 30% of 1.8V and „HIGH“ level threshold is 70% of 1.8V regardless of the external I/O voltage V_{IO} . This fixed internal reference voltage can also lead to minor timing violations to the I²C bus specification from NXP concerning the minimum/maximum hold time requirement.

Characteristics (Ta = 25°C)

Parameter	Symbol	Value			Unit
		min.	typ.	max.	

General

Conditions for OFF mode ¹⁾	$V_{DD,off}$			1.4	V
On-time (from OFF to STAND-BY) ¹⁾	t_{on}			0.2	s
Threshold level for STAND-BY mode ¹⁾	$V_{DD,on}$	2.0			V
Transition time between modes (STAND-BY ...TRIGGERED ...FREE-RUNNING)	t_{trans}			10	ms
STAND-BY mode current consumption	$I_{DD,stby}$			5	μ A
OFF mode current consumption	$I_{DD,off}$			2	μ A

1) Start-up sequence

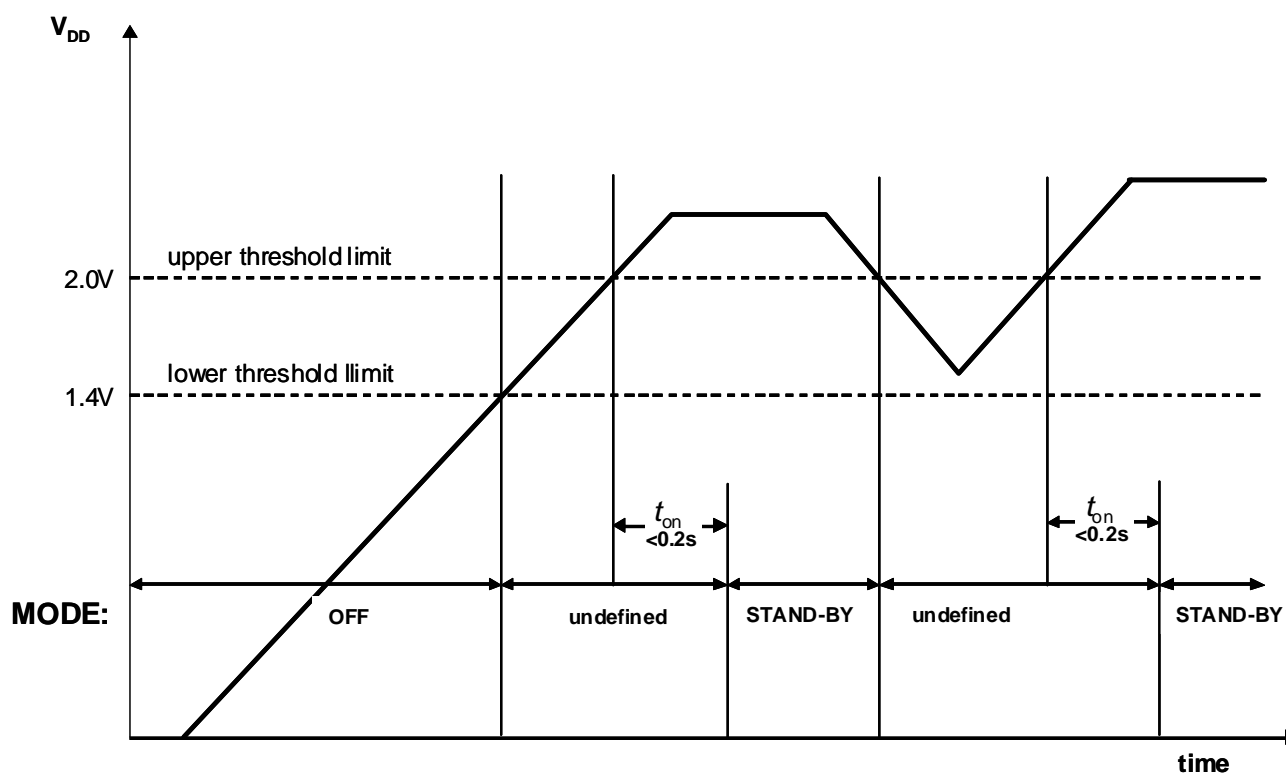

The threshold limit where the device switches from OFF to STAND-BY is between $V_{DD}=1.4V$ and $V_{DD}=2.0V$. Within 0.2s after exceeding the threshold voltage the device will switch from OFF to STAND-BY mode.

Characteristics ($T_a = 25^\circ\text{C}$)

Parameter	Symbol	Value			Unit
		min.	typ.	max.	
Proximity Sensor (PS)					
Wavelength of max. sensitivity	$\lambda_{S,max}$		850		nm
Spectral range of sensitivity (50% of S_{max})	$\lambda_{S,50\%}$		750 ... 1000		nm
Sensitivity range, $\lambda = 850\text{nm}$ ²⁾	E_e		0.09 ... 1.6		mW/cm ²
Sensor signal (logarithmic) ²⁾			0 ... 254		counts
Measurement accuracy for irradiance E_e , $\lambda=850\text{nm}$ at $E_e=500\mu\text{W}/\text{cm}^2$		- 6		+ 6	dB
LED pulse current, programmable, (only when $V_{LED} - V_{f1, f2, f3} > 0.4\text{V}$) ¹⁾	$I_{LED,PP}$	5		200	mA
Accuracy of LED pulse current	$\Delta I_{LED,PP}$	-20		+20	%
Mean current consumption, FREE-RUNNING (one LED „ON“, $I_f=100\text{mA}$, $t_{rep} = 100\text{ms}$)	I_{act}			300	μA
Modulation frequency of LED current	f_{mod}		667		kHz
Repeat frequency in FREE-RUNNING mode (programmable)	t_{rep}		10 ... 2000		ms
Length of a single LED burst	t_{burst}		300		μs
Length of a measurement cycle for 3 LEDs	t		1		ms
Update of register data after MCU request	t		10		ms
Sunlight suppression		50			klx

¹⁾ DC-offset of 0.5mA has to be added to LED current consumption during LED burst

²⁾ Output signal of the Proximity Sensor

The sensitivity range of the Proximity Sensor is typ. $100 \mu\text{W}/\text{cm}^2$ to $1.0 \text{mW}/\text{cm}^2$. Within this range, the data in the SFH 7770 output register are available in an approximately logarithmic scale. The advantage of the logarithmic scale is the possibility to cover a large range of distance without changing the sensitivity settings of the sensor. In addition the data are then approximately proportional to the distance of an object.

When the irradiation is below $100 \mu\text{W}/\text{cm}^2$, the PS output signal exhibits noise which is typically below 80 output counts (see the dashed line in the graph below).

For irradiation higher than typ. $100\mu\text{W}/\text{cm}^2$, the PS output signal increases monotonically up to a value of typ. 163.

When the irradiation is higher than 1 mW/cm², the PS output signal steps up to a value of 254 output counts.

The proximity signal is converted to a 8 bit signal. When the irradiation is 500 μW/cm² the output is typically 137 (1010 0011). More details on the characteristics of the Proximity Sensor can be seen below.

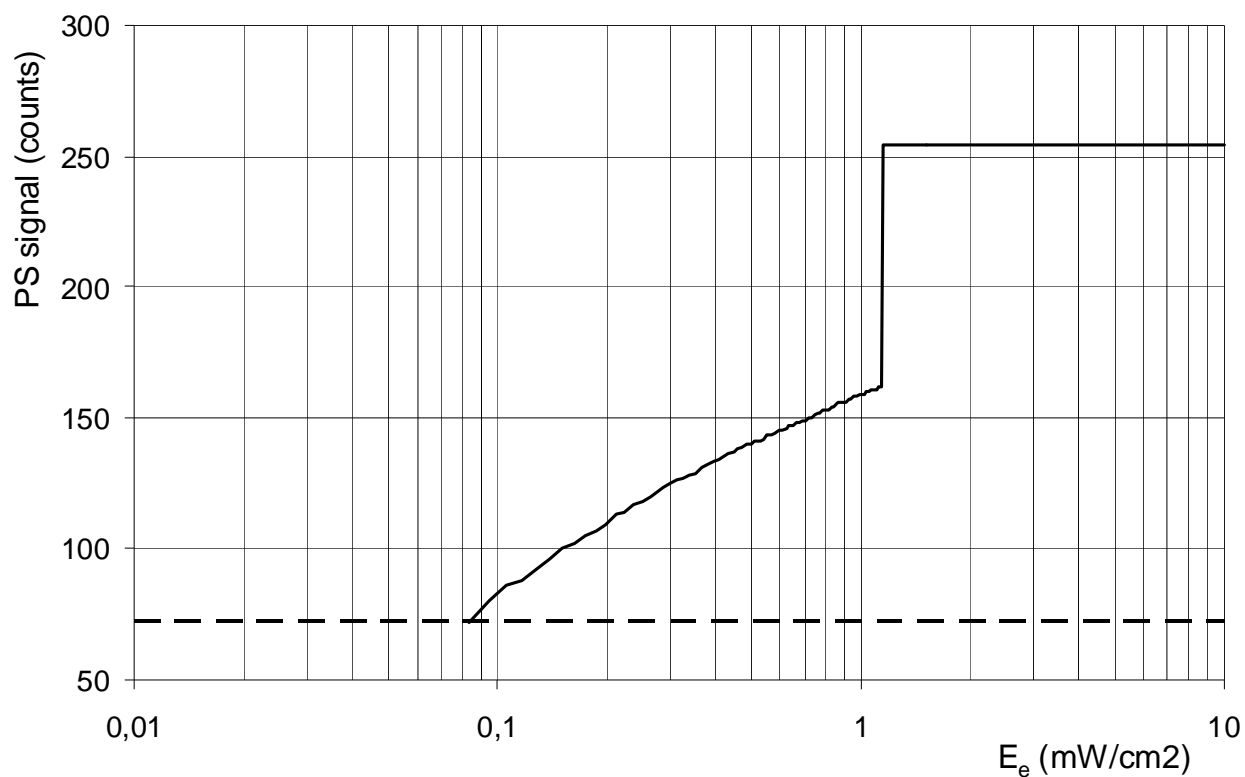

Characteristics (Ta = 25°C)

Parameter	Symbol	Value			Unit
		min.	typ.	max.	

Ambient Light Sensor (ALS)

Wavelength of max. sensitivity	$\lambda_{S \max}$		555		nm
Spectral range of sensitivity (10% of S_{\max})	$\lambda_{S10\%}$		480-660		nm
Measurement range		3		65000	counts
Sensitivity (1000lx)	<i>Out</i>	0.6	1	1.5	count/lx
Deviation from linear output characteristics ¹⁾ X = 100-65000lx X = 10-100lx X = 3-10lx	f_{lin}		±5 ±10 ±30		%
Temperature coefficient for E_V measurement 0°C ... 50°C -15°C ... 70°C	T_{cEv}	- 0.20 - 0.25		+ 0.20 + 0.25	%/K %/K
Update of register data after MCU request	<i>t</i>			100	ms
Measurement repetition rate in FREE-RUNNING mode, programmable	t_{rep}		100 ... 2000		ms
Mean current consumption in FREE-RUNNING mode, $t_{rep} = 500ms$	I_{act}			200	µA
Current consumption in STAND-BY mode	I_{stby}			5	µA
Error by Flicker noise (caused by bulbs or fluorescent lamps) (f = 50 or 60Hz, 100% modulation)		-5		+5	%

¹⁾ The deviation of the linear output characteristic is referenced to 1000lx and follows the formula:

$$f_{lin} = \left(\frac{Y_X}{Y_{1000lx}} \times \frac{1000lx}{X} - 1 \right) \times 100\%$$

X: sensor illumination level in lux

Y_X : sensor output / measurement value at illumination level X

Y_{1000lx} : sensor output / measurement value at illumination level 1000lx

Software reset and control of the Ambient Light Sensor

R/W-Register 0x80										
Bit	7	6	5	4	3	2		1	0	
	not used					complete SW reset		mode of Ambient Light Sensor		
default	00000					0		00 STAND-BY		
						1 SW reset		00 STAND-BY		
								01 STAND-BY		
								10 TRIGGERED (by MCU)		
								11 FREE-RUNNING (internally triggered)		

SW reset (Bit 3 „H“) starts sets all registers to default (same as POWER UP). Set back to „L“ by SFH7770 automatically.

Control of the Proximity Sensor

R/W-Register 0x81									
Bit	7	6	5	4	3	2	1		0
	not used						mode of Proximity Sensor		
default	XXXXXX						00 STAND-BY		
							00 STAND-BY		
							01 STAND-BY		
							10 TRIGGERED by MCU		
							11 FREE-RUNNING (internally triggered)		

Emitter current setting

R/W-Register 0x82								
Bit	7	6	5	4	3	2	1	0
	activation of LEDs		setting LED2 pulse current			setting LED1 pulse current		
default	00		011 50 mA			011 50 mA		
	00 LED1 active		000 5 mA			000 5 mA		
	01 LED1 and 2 active		001 10 mA			001 10 mA		
	10 LED1 and 3 active		010 20 mA			010 20 mA		
	11 all LEDs active		011 50 mA			011 50 mA		
			100 100 mA			100 100 mA		
			101 150 mA			101 150 mA		
			110 200 mA			110 200 mA		

Emitter current setting

R/W-Register 0x83								
Bit	7	6	5	4	3	2	1	0
	not used					setting LED3 pulse current		
default	XXXXX					011 50 mA		
						000 5 mA		
						001 10 mA		
						010 20 mA		
						011 50 mA		
						100 100 mA		
						101 150 mA		
						110 200 mA		

MCU-triggered measurement (for Ambient Light Sensor and Proximity Sensor)

R/W-Register 0x84									
Bit	7	6	5	4	3	2	1		0
	not used					trigger ambient light		trigger proximity	
default	XXXXXX					1		1	

If „1“ is set, a new measurement will start after the I²C stop command from the MCU. As soon as the measurement is finished, the corresponding bit of the register will be set to „0“ automatically by the SFH7770.

Proximity measurement: time interval settings (repetition time) for FREE-RUNNING mode

R/W-Register 0x85								
Bit	7	6	5	4	3	2	1	0
	not used				time-interval			
default	XXXX				0101	100 ms		
					0000	10 ms		
					0001	20 ms		
					0010	30 ms		
					0011	50 ms		
					0100	70 ms		
					0101	100 ms		
					0110	200 ms		
					0111	500 ms		
					1000	1000 ms		
					1001	2000 ms		

Ambient light measurement: time interval settings (repetition time) for FREE-RUNNING mode

R/W-Register 0x86								
Bit	7	6	5	4	3	2	1	0
	not used					time-interval		
default	XXXXX					010	500 ms	
						000	100 ms	
						001	200 ms	
						010	500 ms	
						011	1000 ms	
						100	2000 ms	

Part number and revision Identification

R-Register 0x8A								
Bit	7	6	5	4	3	2	1	0
	Part number ID				Revision ID			
	1001				XXXX (start with 0000)			

Manufacturer Identification

R-Register 0x8B								
Bit	7	6	5	4	3	2	1	0
	Manufacturer Identification							
	0000				0011			

Ambient Light measurement data (0x8C: LSB , 0x8D: MSB)

R-Register 0x8C								
Bit	7	6	5	4	3	2	1	0
	LSB data							
default	00000000							

R-Register 0x8D								
Bit	7	6	5	4	3	2	1	0
	MSB data							
default	00000000							

The result of the Ambient Light Sensor is a 16bit word with MSB and LSB and is stored in two registers.. The binary data can be converted directly to decimal „lx“ values (max. 65535lx)

Status of measurement data for Ambient Light Sensor (ALS) and Proximity Sensor (PS)

R-Register 0x8E								
Bit	7	6	5	4	3	2	1	0
	ALS threshold	ALS data	PS LED3 threshold	PS LED3 data	PS LED2 threshold	PS LED2 data	PS LED1 threshold	PS LED1 data
default	00000000							

When the measurement data are available in the register, the corresponding status bit (bit 6 for ambient-light; bit 4, 2 and 0 for proximity) in register 0x8E is set to „1“. When the measurement data have been read by the MCU, the status bit is automatically set back to „0“.

Bit 7 is set „1“ when the measured ALS value is outside the threshold level settings (register 0x96... 0x99). Bit 1, 3 and 5 are set when the measured PS value is above the threshold level (register 0x93... 0x95).

The status of register 0x8E will always be updated when a new measurement is available.

Proximity measurement data (LED 1 , 8bit, logarithmic)

R-Register 0x8F								
Bit	7	6	5	4	3	2	1	0
	data							
default	00000000							

Proximity measurement data (LED 2 , 8bit, logarithmic)

R-Register 0x90								
Bit	7	6	5	4	3	2	1	0
	data							
default	00000000							

Proximity measurement data (LED 3 , 8bit, logarithmic)

R-Register 0x91								
Bit	7	6	5	4	3	2	1	0
	data							
default	00000000							

Interrupt register / INT output.

R/W-Register 0x92								
Bit	7	6	5	4	3	2	1	0
	not used	Interrupt trigger source		not used	Output mode	Output polarity	Interrupt mode (triggered by..)	
R/W	not used	R only		not used	R/W	R/W	R/W	
default	X	00		X	1	0	00	
		00 ALS			0 latched	0 active L	00 Z state	
		01 PS (LED 1)			1 not latched	1 active H	01 only PS	
		10 PS (LED 2)					10 only ALS	
		11 PS (LED 3)					11 PS and ALS	

In Bit6/5 the source which triggers the interrupt is noted. Data from the status register (0x8E) are used. In latched mode (set by bit3) this remains unchanged until the Interrupt register has been read by the MCU, afterwards it is set to 0 automatically. In unlatched mode it is updated after every measurement. The output polarity (pin 5 of the SFH7770) can be changed by bit 2.

The interrupt can be triggered by the Ambient Light Sensor and / or by the Proximity Sensor; this can be set by the Interrupt mode (bit 1/bit 0). When bit 1 and bit 0 is set to 0, the INT output is in the high Z state (high impedance).

Threshold level for Proximity Sensor (LED 1)

RW-Register 0x93								
Bit	7	6	5	4	3	2	1	0
	data							
default	11111111							

Threshold level for Proximity Sensor (LED 2)

RW-Register 0x94								
Bit	7	6	5	4	3	2	1	0
	data							
default	11111111							

Threshold level for Proximity Sensor (LED 3)

RW-Register 0x95								
Bit	7	6	5	4	3	2	1	0
	data							
default	11111111							

Upper threshold level for Ambient Light Sensor (LSB)

RW-Register 0x96								
Bit	7	6	5	4	3	2	1	0
	LSB data (upper threshold)							
default	11111111							

Upper threshold level for Ambient Light Sensor (MSB)

RW-Register 0x97								
Bit	7	6	5	4	3	2	1	0
	MSB data (upper threshold)							
default	11111111							

Lower threshold level for Ambient Light Sensor (LSB)

RW-Register 0x98								
Bit	7	6	5	4	3	2	1	0
	LSB data (upper threshold)							
default	11111111							

Lower threshold level for Ambient Light Sensor (MSB)

RW-Register 0x99								
Bit	7	6	5	4	3	2	1	0
	LSB data (upper threshold)							
default	11111111							

Package Outlines

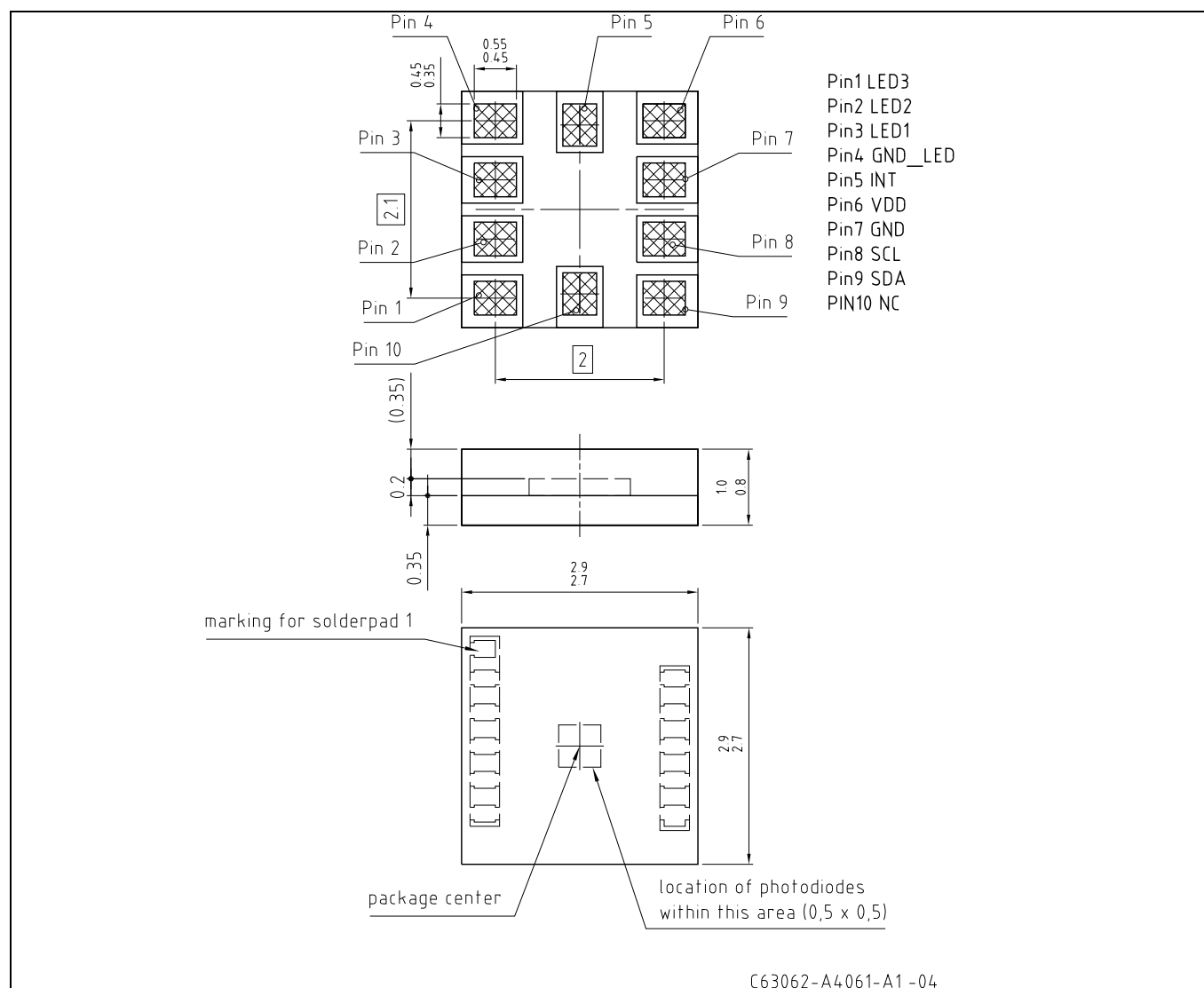

Maße in mm/ Dimensions in mm

Pin 1 identifier: one additional yellow pad in the edge, visible in front view

Gurtung / Polarität und Lage

Verpackungseinheit 3000/Rolle, ø180 mm

Method of Taping / Polarity and Orientation

Packing unit 3000/reel, ø180 mm

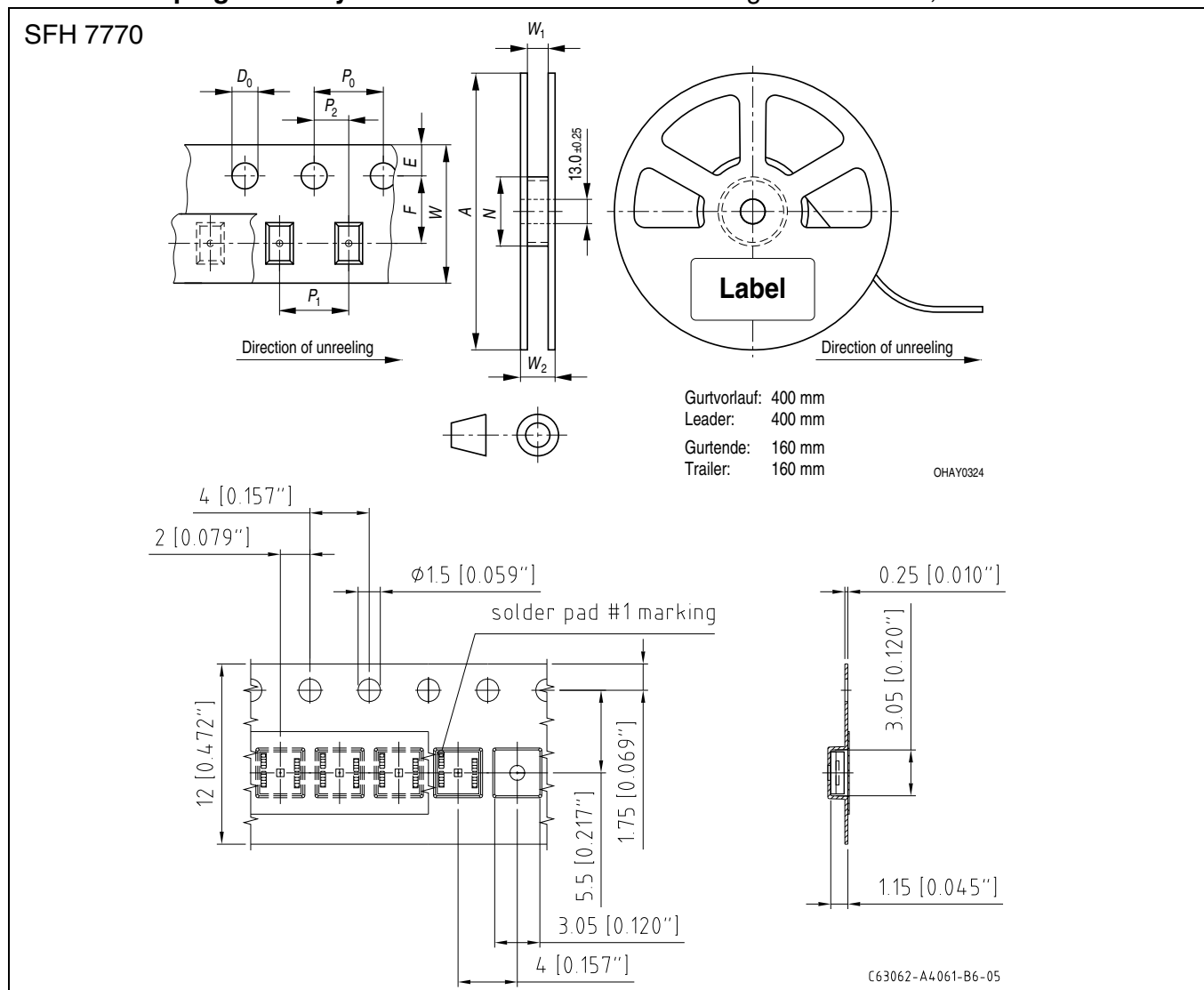

Maße in mm (inch) / Dimensions in mm (inch).

Tape dimensions in mm (inch)

W	P ₀	P ₁	P ₂	D ₀	E	F
8 +0.3 / -0.1	4 ± 0.1 (0.157 ± 0.004)	4 ± 0.1 (0.157 ± 0.004)	2 ± 0.05 (0.079 ± 0.002)	1.5 + 0.1 (0.059 + 0.004)	1.75 ± 0.1 (0.069 ± 0.004)	3.5 ± 0.05 (0.138 ± 0.002)

Reel dimensions in mm (inch)

A	W	N _{min}	W ₁	W _{2 max}
180 (7)	8 (0.315)	60 (2.362)	8.4 + 2 (0.331 + 0.079)	14.4 (0.567)

Recommended solderpad design

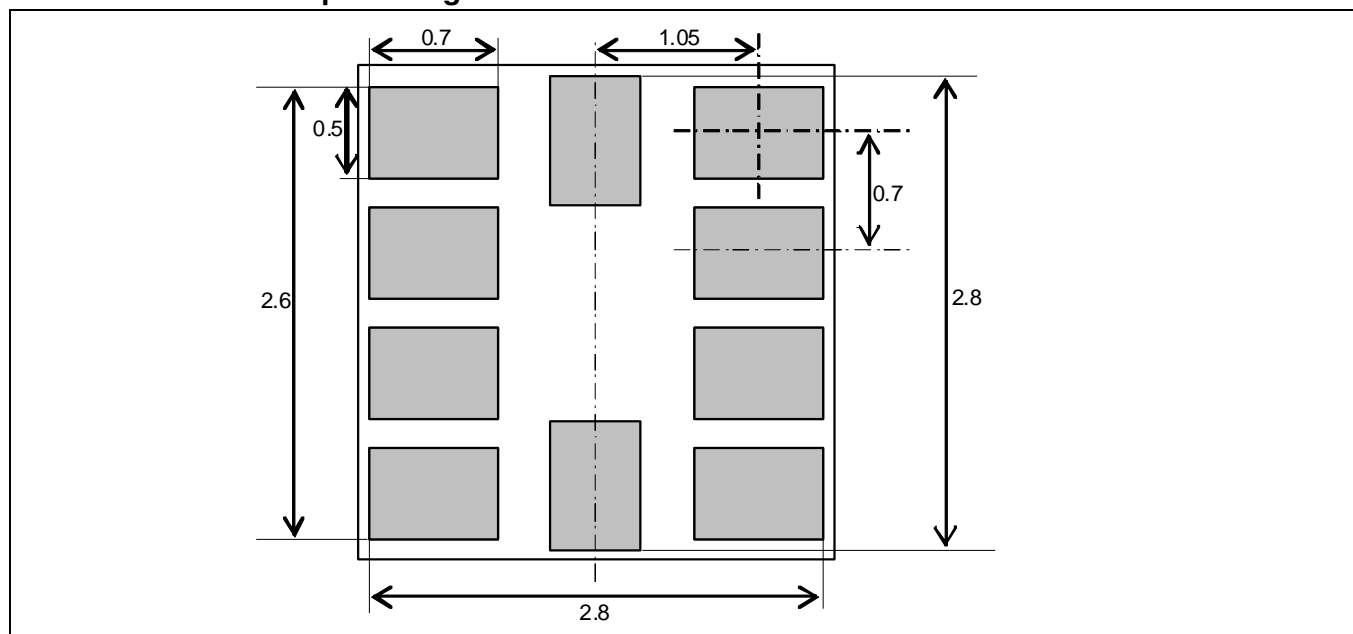

Maße in mm/ Dimensions in mm

Lötbedingungen**Soldering Conditions****Reflow Lötprofil für bleifreies Löt****Reflow Soldering Profile for lead free soldering**

Vorbehandlung nach JEDEC Level 4

Preconditioning acc. to JEDEC Level 4

(nach J-STD-020-D.01)

(acc. to J-STD-020-D.01)

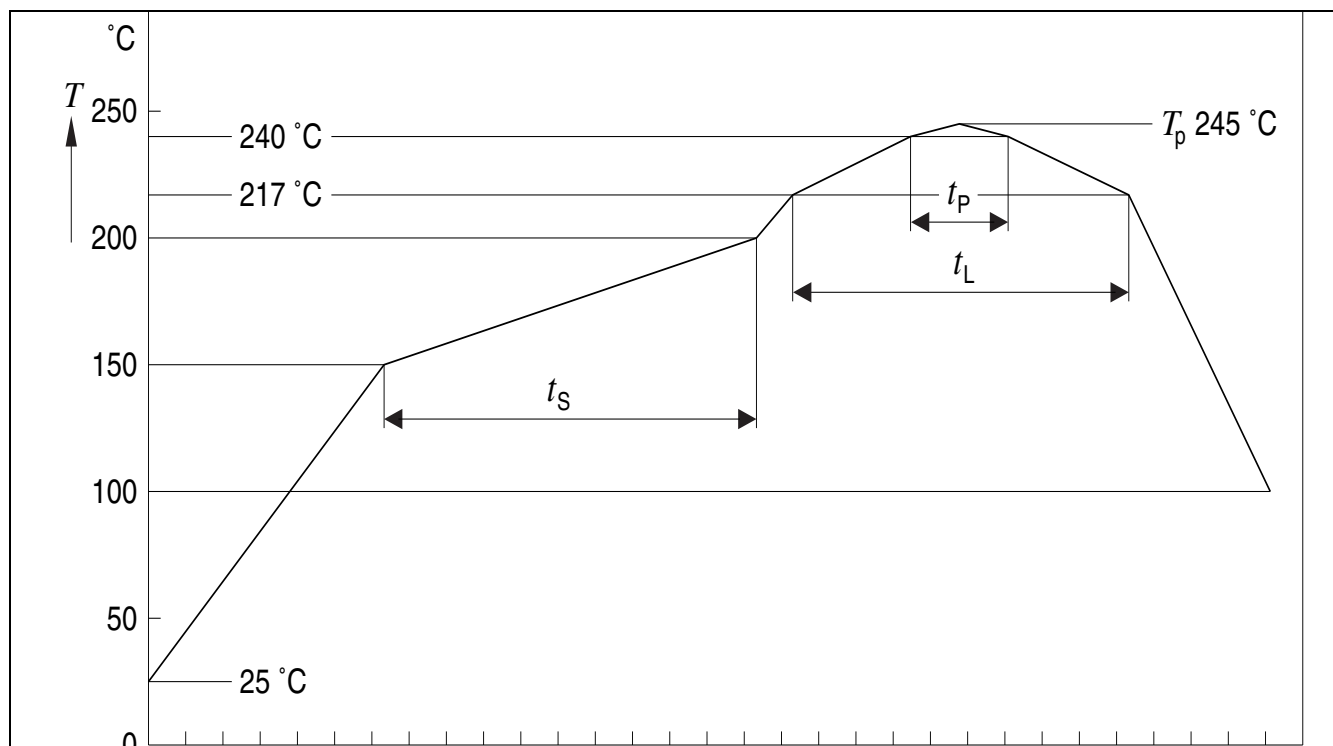

2011-08-30

20

Pb-Free (SnAgCu) Assembly		
Profile Feature	Recommendation	Max. Ratings
Ramp-up Rate to Preheat*) 25°C to 150°C	2°C / sec	3°C / sec
Time t_s from T_{Smin} to T_{Smax} (150°C to 200°C)	100s	min. 60sec max. 120sec
Ramp-up Rate to Peak*) T_{Smax} to T_P	2°C / sec	3°C / sec
Liquidus Temperture T_L	217°C	
Time t_L above T_L	80sec	max. 100sec
Peak Temperature T_P	245°C	max. 260°C
Time t_p within 5°C of the specified peak temperature $T_P - 5K$	20sec	min. 10sec max. 30sec
Ramp-down Rate* T_P to 100°C	3°C / sec	6°C / sec maximum
Time 25°C to Peak temperature		max. 8 min.

All temperatures refer to the center of the package, measured on the top of the component

* slope calculation $\Delta T/\Delta t$: Δt max. 5 sec; fulfillment for the whole T-range

Published by
OSRAM Opto Semiconductors GmbH

Leibnizstr. 4, D-93055 Regensburg

www.osram-os.com

© All Rights Reserved.

The information describes the type of component and shall not be considered as assured characteristics. Due to the special conditions of the manufacturing processes of Sensor, the typical data or calculated correlations of technical parameters can only reflect statistical figures. These do not necessarily correspond to the actual parameters of each single product, which could differ from the typical data and calculated correlations or the typical characteristic line. If requested, e.g. because of technical improvements, these typ. data will be changed without any further notice.

Terms of delivery and rights to change design reserved. Due to technical requirements components may contain dangerous substances. For information on the types in question please contact our Sales Organization.

Packing

Please use the recycling operators known to you. We can also help you – get in touch with your nearest sales office. By agreement we will take packing material back, if it is sorted. You must bear the costs of transport. For packing material that is returned to us unsorted or which we are not obliged to accept, we shall have to invoice you for any costs incurred.

Components used in life-support devices or systems must be expressly authorized for such purpose! Critical components ¹, may only be used in life-support devices or systems ² with the express written approval of OSRAM OS.

¹ A critical component is a component used in a life-support device or system whose failure can reasonably be expected to cause the failure of that life-support device or system, or to affect its safety or effectiveness of that device or system.

² Life support devices or systems are intended (a) to be implanted in the human body, or (b) to support and/or maintain and sustain human life. If they fail, it is reasonable to assume that the health of the user may be endangered.