



# Frontier Electronics Corp.

667 E. COCHRAN STREET, SIMI VALLEY, CA 93065

TEL: (805) 522-9998 FAX: (805) 522-9989

E-mail: [frontiersales@frontierusa.com](mailto:frontiersales@frontierusa.com)

Web: <http://www.frontierusa.com>

## 3A ULTRA FAST RECOVERY RECTIFIER

### BYT56A THRU BYT56M

#### FEATURES

- FAST RECOVERY TIMES
- UL 94V0 FLAME RETARDANT EPOXY MOLDING COMPOUND
- DIFFUSED JUNCTION
- LOW COST
- HIGH SURGE CURRENT CAPABILITY
- BEVEL ROUND CHIP, AVALANCHE OPERATION

#### MECHANICAL DATA

- CASE: TRANSFER MOLDED, DO201AD, DIMENSIONS IN INCHES AND (MILLIMETERS)
- LEADS: SOLDERABLE PER MIL-STD-202, METHOD 208
- POLARITY: CATHODE INDICATED BY COLOR BAND
- WEIGHT: 1.2 GRAMS

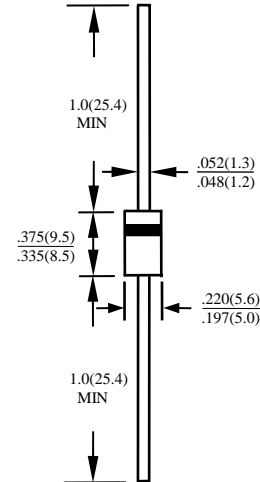

MAXIMUM RATINGS AND ELECTRICAL CHARACTERISTICS RATINGS AT 25°C AMBIENT TEMPERATURE UNLESS OTHERWISE SPECIFIED SINGLE PHASE, HALF WAVE, 60 HZ, RESISTIVE OR INDUCTIVE LOAD. FOR CAPACITIVE LOAD, DERATE CURRENT BY 20%

RATINGS	SYMBOL	BYT56A	BYT56B	BYT56D	BYT56G	BYT56J	BYT56K	BYT56M	UNITS
MAXIMUM RECURRENT PEAK REVERSE VOLTAGE	$V_{RRM}$	50	100	200	400	600	800	1000	V
MAXIMUM RMS VOLTAGE	$V_{RMS}$	35	70	140	280	420	560	700	V
MAXIMUM DC BLOCKING VOLTAGE	$V_{DC}$	50	100	200	400	600	800	1000	V
MAXIMUM AVERAGE FORWARD RECTIFIED CURRENT 0.375"(9.5mm) LEAD LENGTH AT $T_A=55^\circ\text{C}$	$I_O$	3.0							A
PEAK FORWARD SURGE CURRENT, 8.3ms SINGLE HALF SINE-WAVE SUPERIMPOSED ON RATED LOAD	$I_{FSM}$	150							A
TYPICAL JUNCTION CAPACITANCE (NOTE 1)	$C_j$	75				50			PF
TYPICAL THERMAL RESISTANCE (NOTE 2)	$R_{\theta ja}$	20							$^\circ\text{C/W}$
STORAGE TEMPERATURE RANGE	$T_{STG}$	-55 TO + 150							$^\circ\text{C}$
OPERATING TEMPERATURE RANGE	$T_{OP}$	-55 TO + 150							$^\circ\text{C}$

#### ELECTRICAL CHARACTERISTICS ( $A_T T_A = 25^\circ\text{C}$ UNLESS OTHERWISE NOTED)

CHARACTERISTICS	SYMBOL	BYT56A	BYT56B	BYT56D	BYT56G	BYT56J	BYT56K	BYT56M	UNITS
MAXIMUM FORWARD VOLTAGE AT $I_O$ DC	$V_F$	1.4							V
MAXIMUM REVERSE CURRENT AT 25°C	$I_R$	5							$\mu\text{A}$
MAXIMUM REVERSE CURRENT AT 100°C	$I_R$	50							$\mu\text{A}$
MAXIMUM REVERSE RECOVERY TIME (NOTE3)	$T_{RR}$	100							nS

- NOTE:
1. MEASURED AT 1 MHZ AND APPLIED REVERSE VOLTAGE OF 4.0 VOLTS
  2. BOTH LEADS ATTACHED TO HEAT SINK 63.5x63.5x1t(mm) COPPER PLATE AT LEAD LENGTH 5mm
  3. REVERSE RECOVERY TEST CONDITIONS:  $I_F=0.5\text{A}, I_R=1.0\text{A}, I_{RR}=0.25\text{A}$

# RATINGS AND CHARACTERISTIC CURVE BYT56A THRU BYT56M

FIG. 1-TEST CIRCUIT DIAGRAM AND REVERSE RECOVERY TIME CHARACTERISTIC

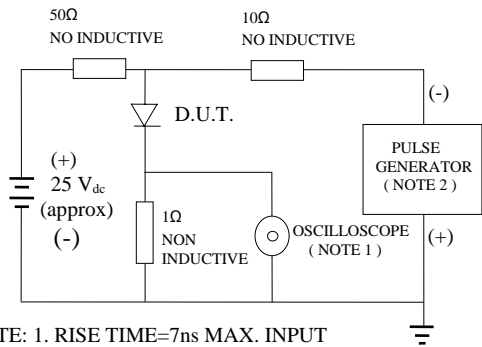

NOTE: 1. RISE TIME=7ns MAX. INPUT IMPEDANCE=1 MOhms 22PF  
 2. RISE TIME =10ns MAX. SOURCE IMPEDANCE=50OHMS

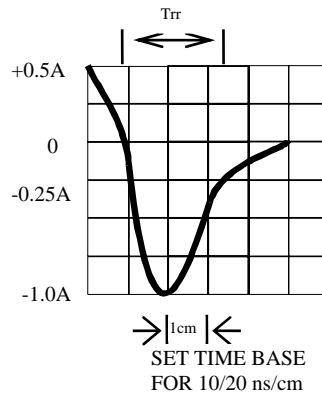

FIG. 2 -TYPICAL FORWARD CURRENT DERATING CURVE

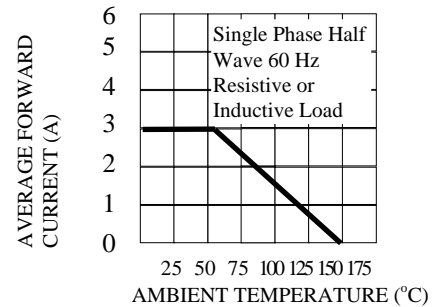

FIG. 3 -TYPICAL REVERSE CHARACTERISTICS

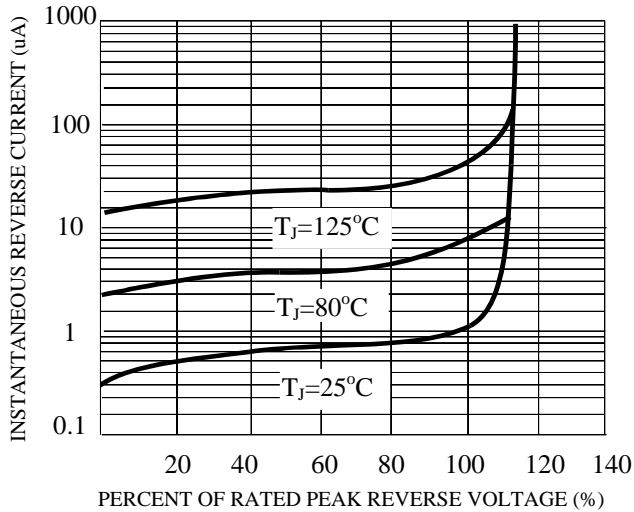

FIG. 4 -TYPICAL INSTANTANEOUS FORWARD CHARACTERISTICS

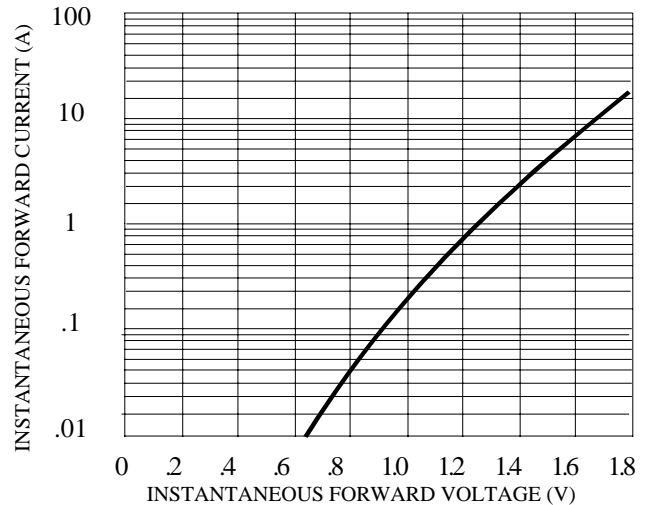

FIG. 5 -MAXIMUM NON-REPETITIVE FORWARD SURGE CURRENT

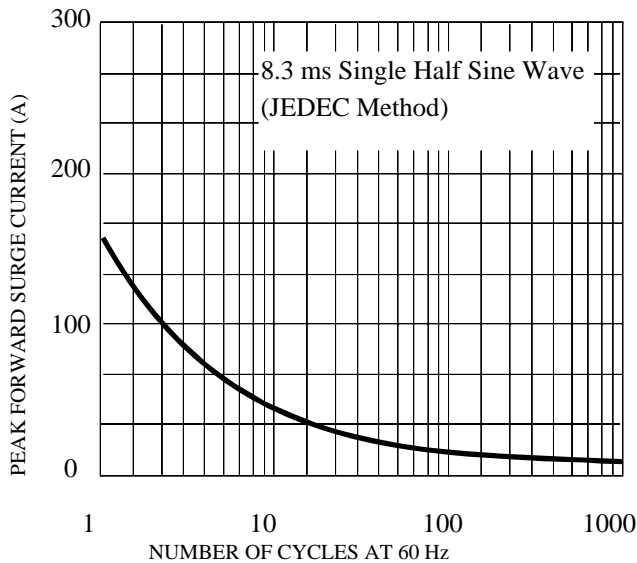

FIG. 6 -TYPICAL JUNCTION CAPACITANCE

