



Dual N-Channel Enhancement Mode Field Effect Transistor

PRODUCT SUMMARY		
V _{DSS}	I _D	R _{DS(ON)} (mΩ) Max
20V	11A	7.2 @ V _{GS} =4.5V
		7.5 @ V _{GS} =4.0V
		8.2 @ V _{GS} =3.7V
		9.0 @ V _{GS} =3.1V
		10.2 @ V _{GS} =2.5V

FEATURES

- Super high dense cell design for low R_{DS(ON)}.
- Rugged and reliable.
- Surface Mount Package.
- ESD Protected.

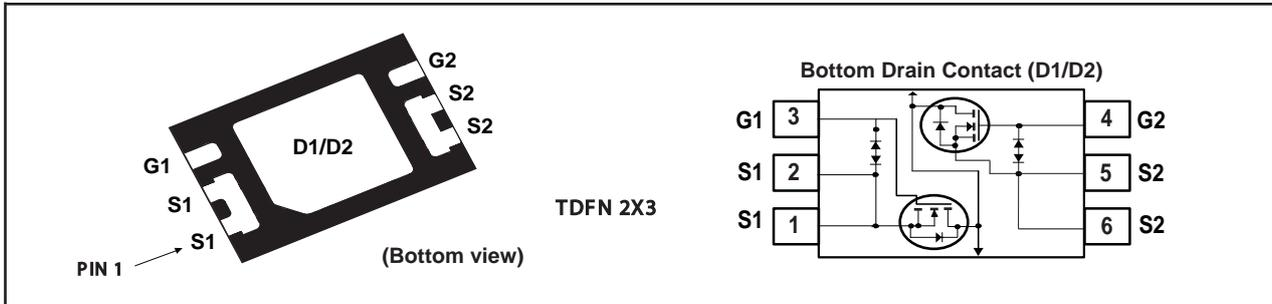

ABSOLUTE MAXIMUM RATINGS (T_A=25°C unless otherwise noted)

Symbol	Parameter	Limit	Units
V _{DS}	Drain-Source Voltage	20	V
V _{GS}	Gate-Source Voltage	±12	V
I _D	Drain Current-Continuous ^a	T _A =25°C	11
		T _A =70°C	8.8
I _{DM}	-Pulsed ^b	70	A
P _D	Maximum Power Dissipation ^a	T _A =25°C	1.56
		T _A =70°C	1.00
T _J , T _{STG}	Operating Junction and Storage Temperature Range	-55 to 150	°C

THERMAL CHARACTERISTICS

R _{θJA}	Thermal Resistance, Junction-to-Ambient ^a	80	°C/W
------------------	--	----	------

STF8233

Ver 2.1

ELECTRICAL CHARACTERISTICS (T_A=25°C unless otherwise noted)

Symbol	Parameter	Conditions	Min	Typ	Max	Units
OFF CHARACTERISTICS						
BV _{DSS}	Drain-Source Breakdown Voltage	V _{GS} =0V , I _D =250uA	20			V
I _{DSS}	Zero Gate Voltage Drain Current	V _{DS} =18V , V _{GS} =0V			1	uA
I _{GSS}	Gate-Body Leakage Current	V _{GS} = ±12V , V _{DS} =0V			±10	uA
ON CHARACTERISTICS						
V _{GS(th)}	Gate Threshold Voltage	V _{DS} =V _{GS} , I _D =1.0mA	0.5	0.85	1.5	V
R _{DS(ON)}	Drain-Source On-State Resistance	V _{GS} =4.5V , I _D =5.5A	4.5	6.0	7.2	m ohm
		V _{GS} =4.0V , I _D =5.5A	4.8	6.2	7.5	m ohm
		V _{GS} =3.7V , I _D =5.5A	5.0	6.5	8.2	m ohm
		V _{GS} =3.1V , I _D =5.5A	5.3	7.0	9.0	m ohm
		V _{GS} =2.5V , I _D =5.5A	6.0	8.2	10.2	m ohm
g _{FS}	Forward Transconductance	V _{DS} =5V , I _D =5.5A		38		S
DYNAMIC CHARACTERISTICS ^c						
C _{ISS}	Input Capacitance	V _{DS} =10V, V _{GS} =0V f=1.0MHz		1310		pF
C _{OSS}	Output Capacitance			264		pF
C _{RSS}	Reverse Transfer Capacitance			235		pF
SWITCHING CHARACTERISTICS ^c						
t _{D(ON)}	Turn-On Delay Time	V _{DD} =16V I _D =5.5A		31		ns
t _r	Rise Time			87		ns
t _{D(OFF)}	Turn-Off Delay Time	V _{GS} =4.5V R _{GEN} = 6 ohm		69		ns
t _f	Fall Time			37		ns
Q _g	Total Gate Charge	V _{DS} =16V, I _D =11A, V _{GS} =4.5V		15		nC
Q _{gs}	Gate-Source Charge			3		nC
Q _{gd}	Gate-Drain Charge			7		nC
DRAIN-SOURCE DIODE CHARACTERISTICS AND MAXIMUM RATINGS						
V _{SD}	Diode Forward Voltage	V _{GS} =0V, I _S =11A		0.87	1.2	V
Notes						
a.Surface Mounted on FR4 Board, t ≤ 10sec.						
b.Pulse Test:Pulse Width < 10us, Duty Cycle < 1%.						
c.Guaranteed by design, not subject to production testing.						

Oct,22,2013

STF8233

Ver 2.1

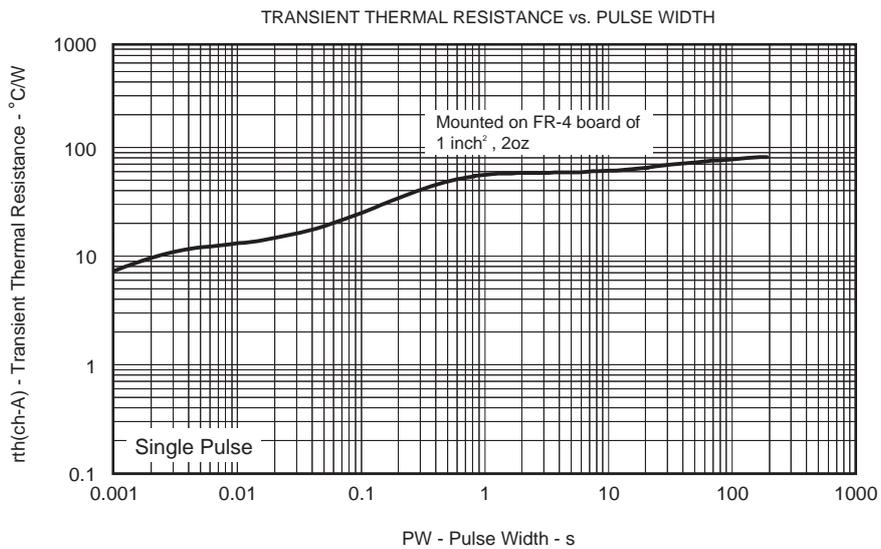
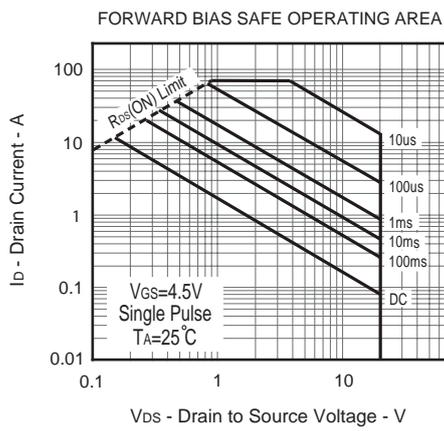
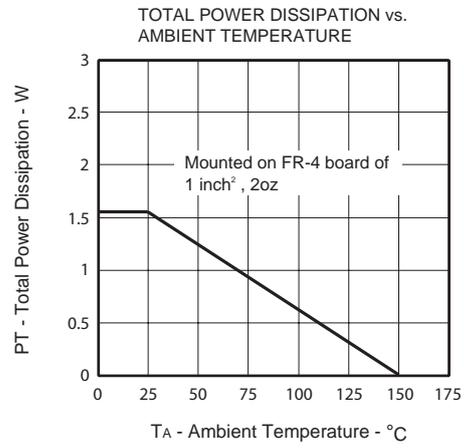
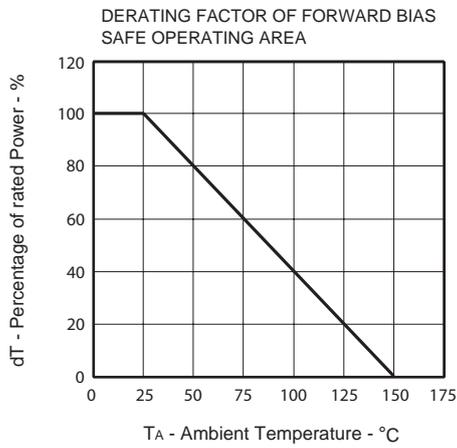

Oct,22,2013

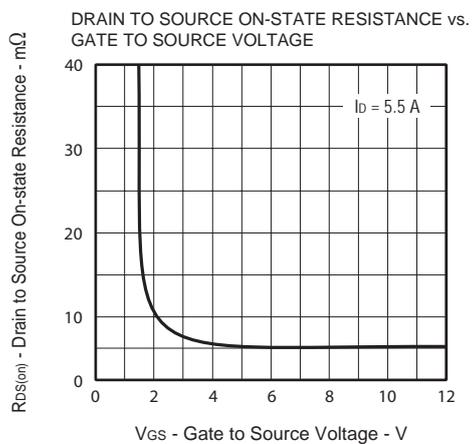
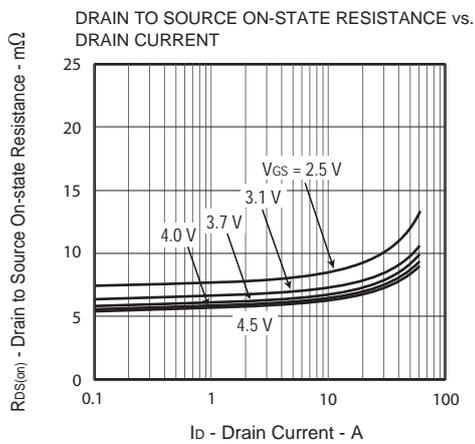
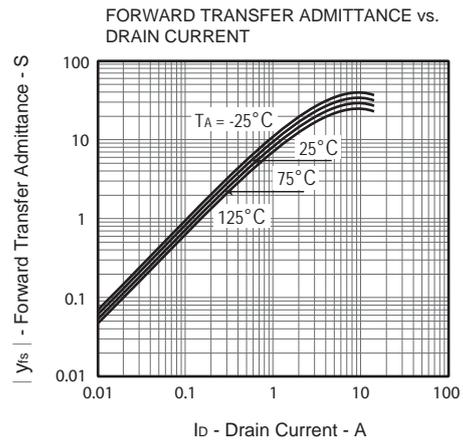
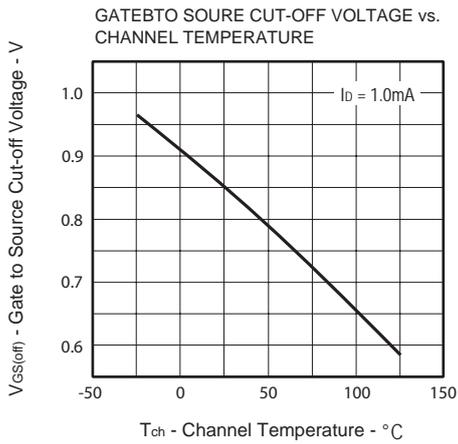
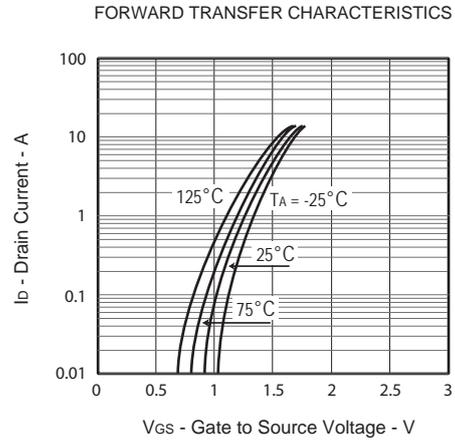
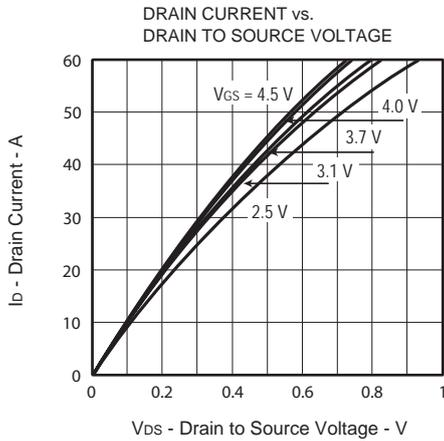

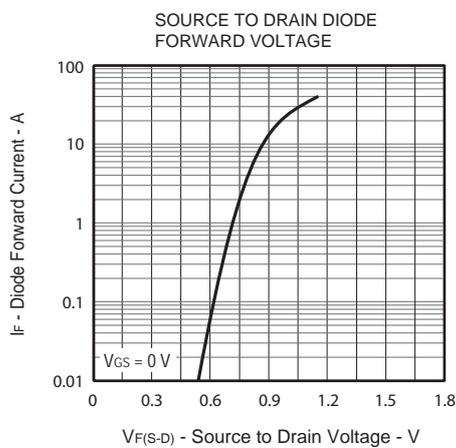
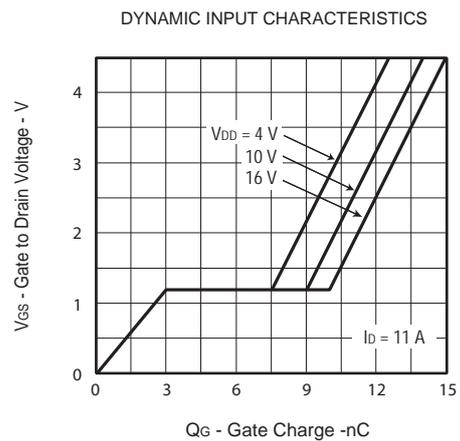
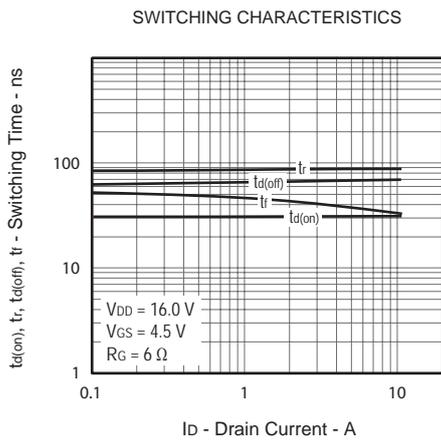
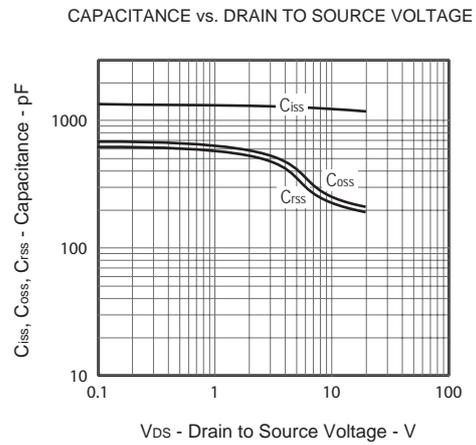
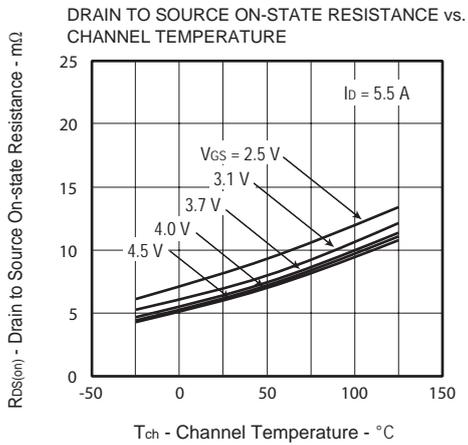

PACKAGE OUTLINE DIMENSIONS

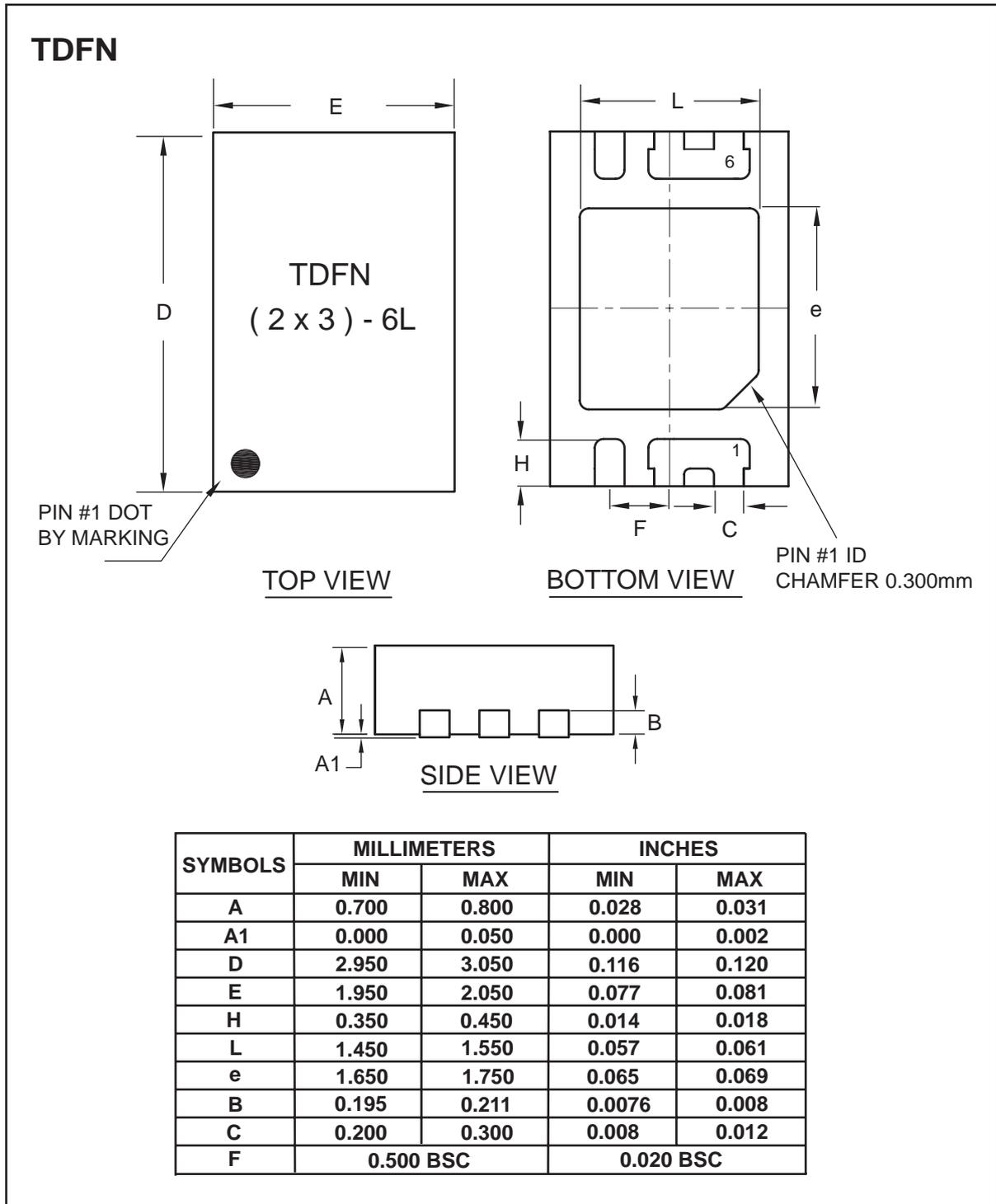

TOP MARKING DEFINITION

