



SF2098H

**915 MHz
SAW Filter**

- **Low Insertion Loss**
- **Direct Match to 50 ohms**
- **2.0 x 1.6 mm Surface-mount Case**
- **Complies with Directive 2002/95/EC (RoHS)** 

Absolute Maximum Ratings

Rating	Value	Units
Maximum Incident Power in Passband	+15	dBm
Maximum DC Voltage on any Non-ground Terminal	3	VDC
Operating Temperature Range	-40 to +85	°C
Storage Temperature Range in Tape and Reel	-40 to +85	°C
Maximum Soldering Profile (5 cycles maximum)	265°C for 10 s	

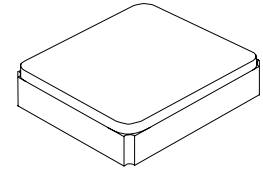

SM2016-4

Electrical Characteristics

Characteristic	Sym	Notes	Min	Typ	Max	Units
Center Frequency	f_c		915			MHz
Insertion Loss, 902 to 928 MHz	IL			2.0	3.0	dB
Amplitude Ripple, Peak-to-Peak, 902 to 928 MHz				0.8	1.5	
Input/Output Return Loss, 902 to 928 MHz				9.5	8.0	
Group Delay Ripple, Peak-to-Peak, 902 to 928 MHz				35	50	ns
Attenuation Referenced to 0 dB:						dB
10 to 857.5 MHz			40	55		
857.5 to 882.5 MHz			35	48		
970 to 1005 MHz			35	48		
1005 to 1110 MHz			45	52		
1110 to 3000 MHz			30	35		
Source impedance	Z_S			50		Ω
Load impedance	Z_L			50		Ω
Single-ended Input / Output Impedance Match	No matching network required for operation at 50 ohms					
Case Style	SM2016-4					
Lid Symbolization (Y=year, W=week)	3H, YW					



CAUTION: Electrostatic Sensitive Device. Observe precautions for handling.

Notes:

1. US and international patents may apply.
2. RFM, stylized RFM logo, and RF Monolithics, Inc. are registered trademarks of RF Monolithics, Inc.

Filter Response Plots

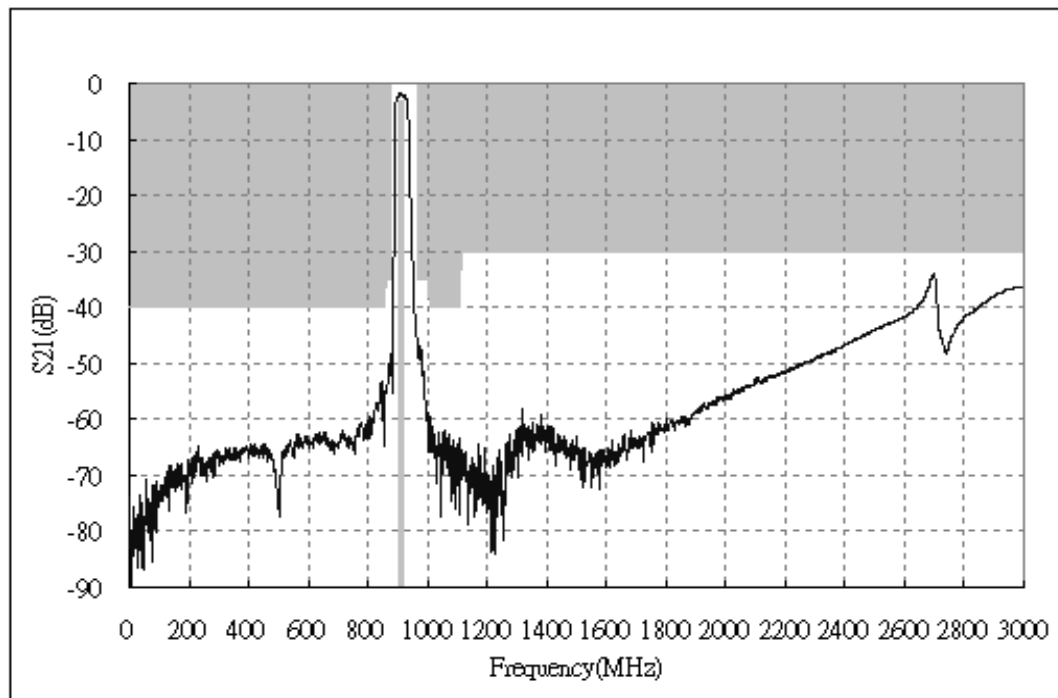
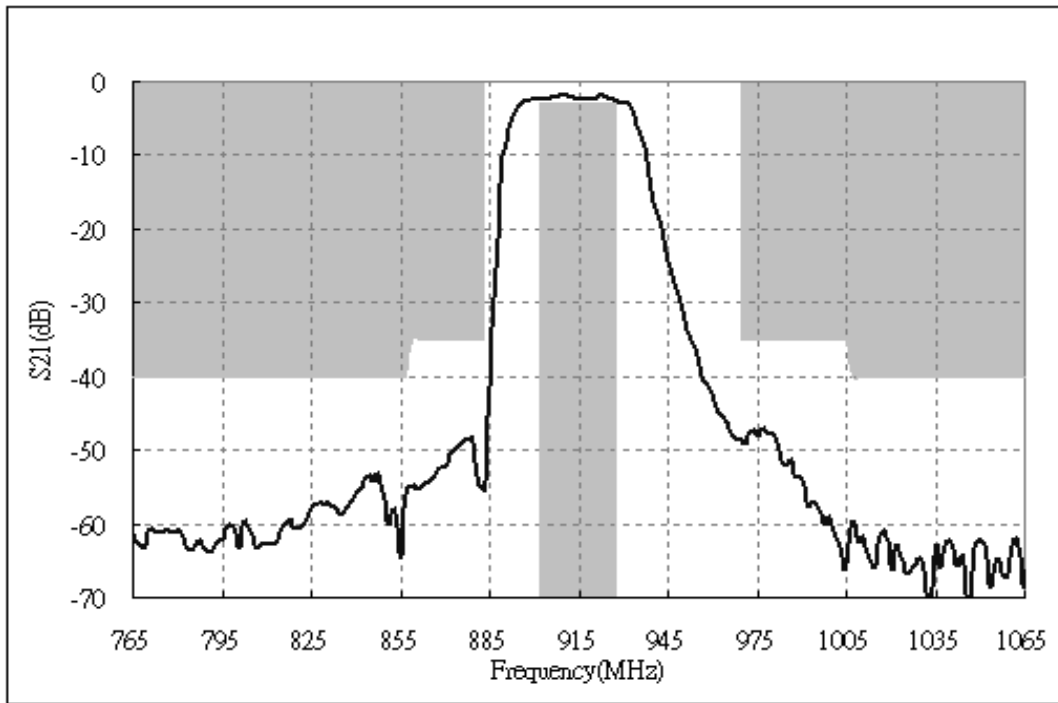

Passband Amplitude Plot

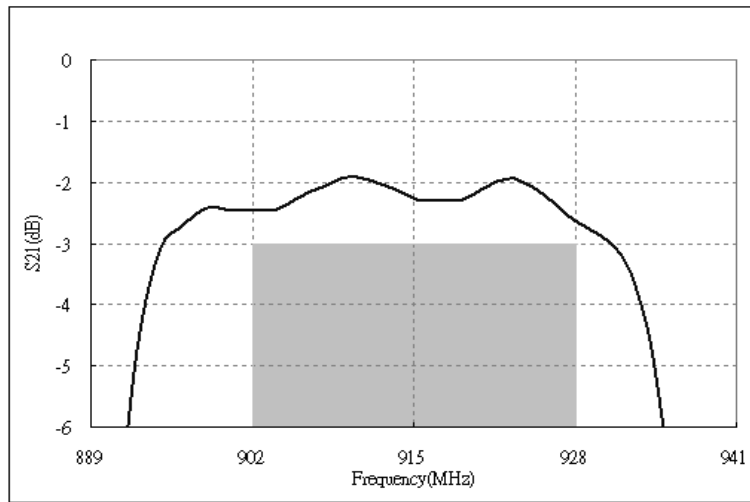

Passband Group Delay Plot

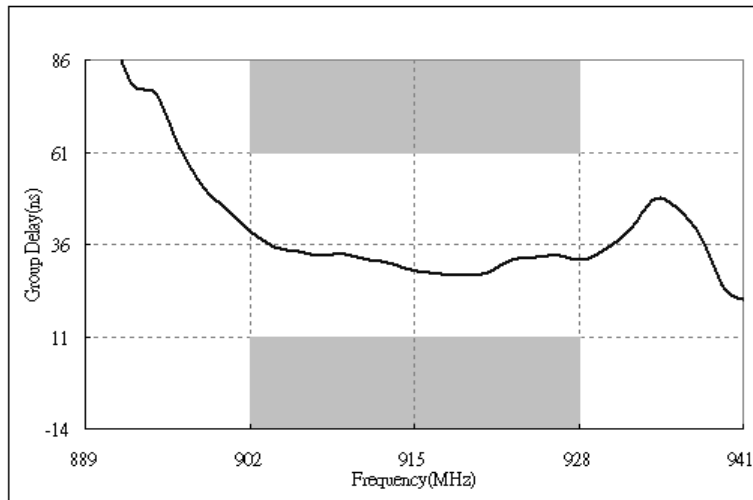

Passband Return Loss Plot

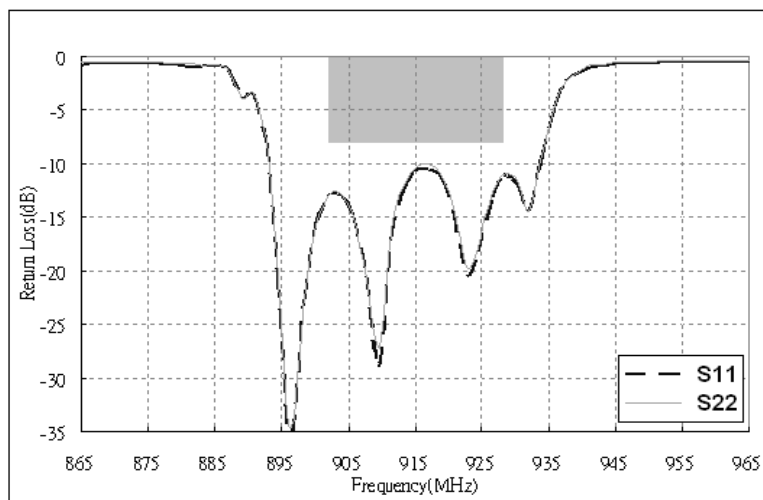

Input and Output Impedance Plots

▶ **Tr2** S11 Smith (R+jX) Scale 1.000U [F2]

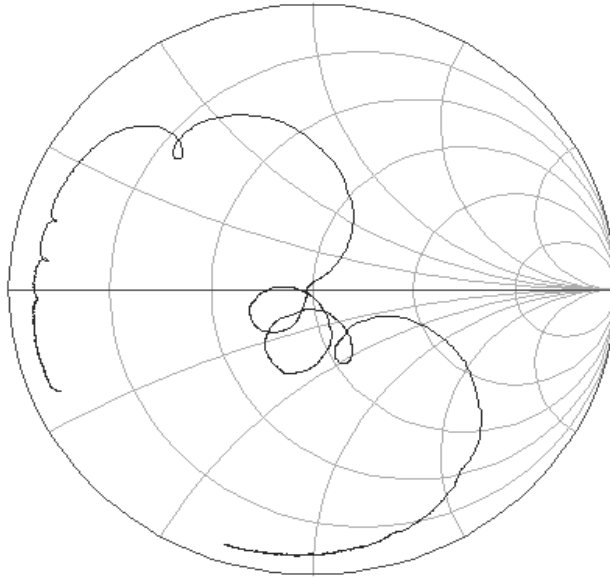

▶ **Tr3** S22 Smith (R+jX) Scale 1.000U [F2]

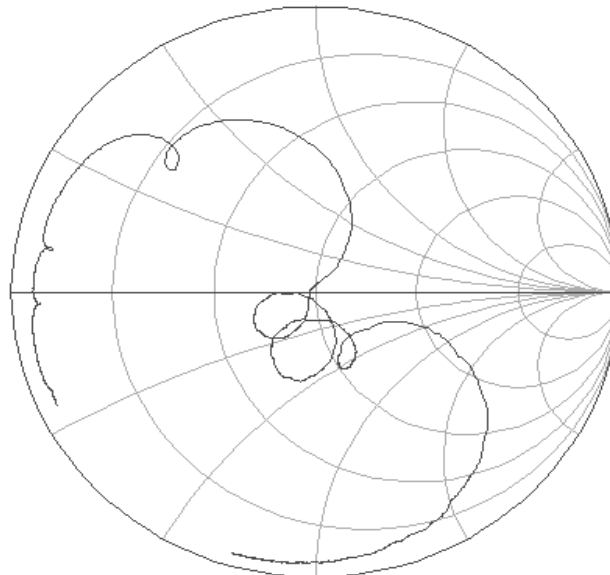

SM2016-4 Case

4-Terminal Ceramic Surface-Mount Case

2.0 X 1.6 mm Nominal Footprint

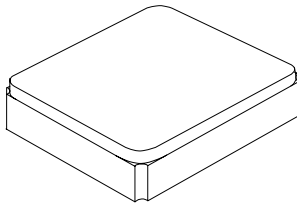

Electrical Connections

Connection	Terminals
Input	1
Output	3
Ground	2, 4

Dimensions	Millimeters			Inches		
	Min	Nom	Max	Min	Nom	Max
A		1.60			0.063	
B		2.00			0.079	
C		0.90			0.035	
D		0.10			0.004	
E		0.10			0.004	
F		0.70			0.028	
G		0.50			0.020	
H		0.10			0.004	

PCB PAD LAYOUT

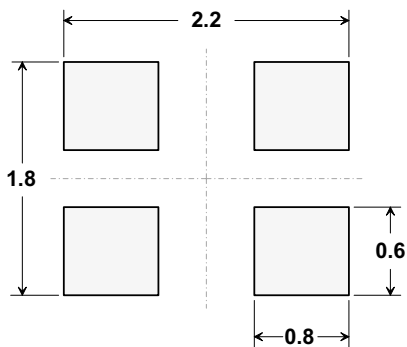

Dimensions in mm
All pads have the same dimensions

TOP VIEW

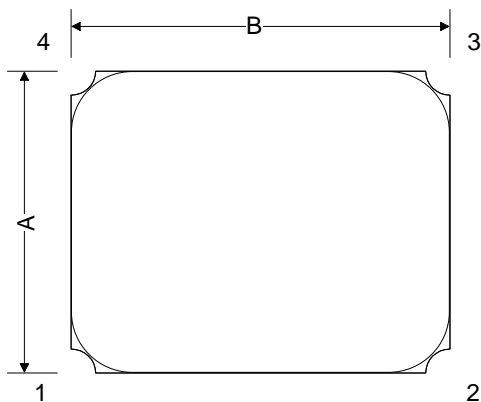

SIDE VIEW

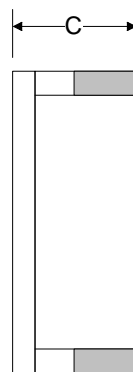

BOTTOM VIEW

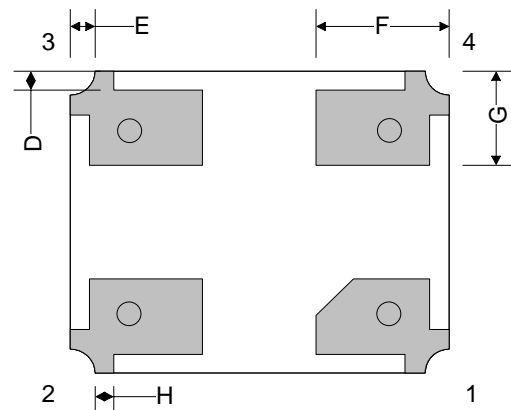

Reel Dimensions

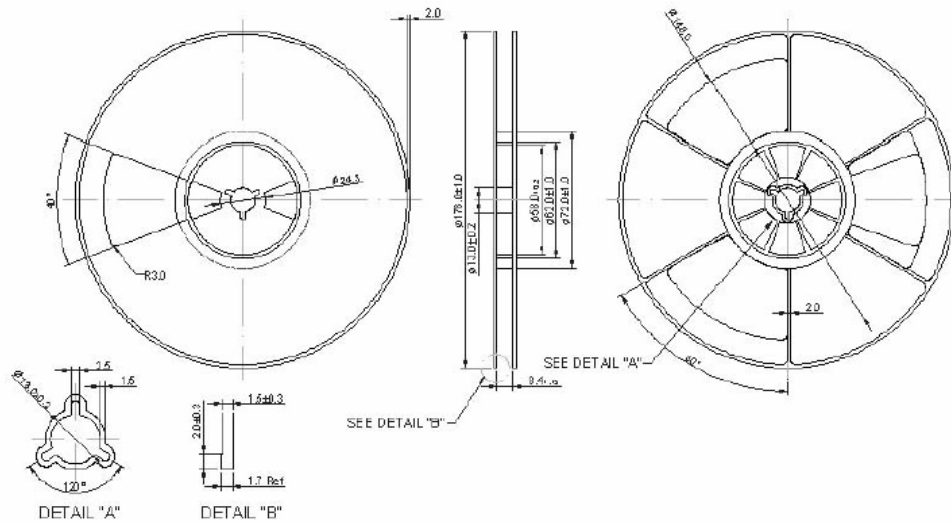

2. TAPE DIMENSION

