

DO NOT SCALE FROM THIS PRINT

DESIGNED & DIMENSIONED IN MILLIMETERS [INCHES]

MCX7-P-C-XX-ST-CA3

GENDER
-P: PLUG

TYPE
-C: CABLE

TERMINATION
-CA3: CABLE (RG179)

ORIENTATION
-ST: STRAIGHT

PLATING SPECIFICATION
-HN: HEAVY GOLD/NICKEL (SEE NOTE 7 & 8)
(SUB-MCX7-P-C-FN-ST-CA3)
(MCX7-P-C-H-ST-CA3-PIN)
(MCX-FER-001-N)

-H: HEAVY GOLD (SEE NOTE 7 & 8)
(SUB-MCX7-P-C-F-ST-CA3)
(MCX7-P-C-H-ST-CA3-PIN)
(MCX-FER-001-F)

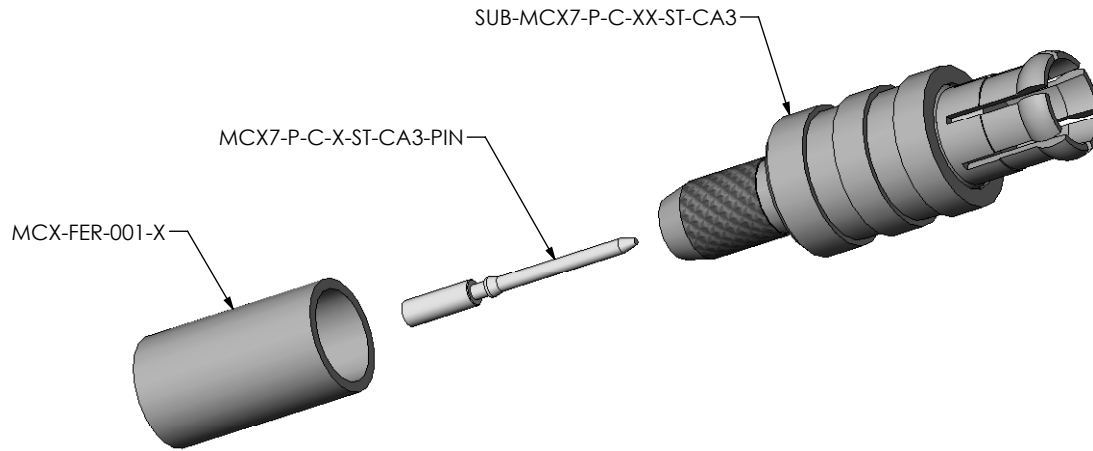
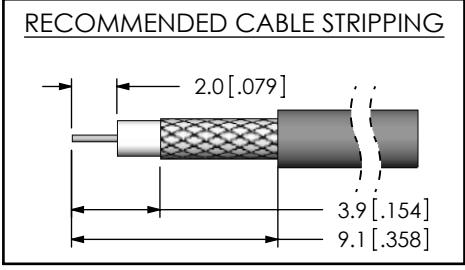

FIG. 1
MCX7-P-C-XX-ST-CA3 SHOWN

NOTES:

1. Ⓢ REPRESENTS A CRITICAL DIMENSION.
2. CENTER CONTACT PUSHOUT FORCE: 10 N [2.25 LB] MIN.
3. SEE SHEET 3 FOR TERMINATION INFORMATION.
4. NOTE DELETED.
5. PRODUCT TO BE PACKAGED PER PACKAGING STANDARD CO-HD-WI-3040-M.
6. RoHS COMPLIANT.
7. COMPONENT PLATING DESIGNATIONS:
-H: .000030" MIN. GOLD OVER .000050" MIN. NICKEL.
-F: .000003" MIN. GOLD OVER .000050" MIN. NICKEL.
-N: .000100" MIN. NICKEL.
8. ASSEMBLY PLATING DESIGNATIONS:
-HN: (CENTER CONTACT)-H:
(OUTER CONTACT)-F:
(REMAINING METAL PARTS)-N:
-H: (CENTER CONTACT)-H:
(OUTER CONTACT)-F:
(REMAINING METAL PARTS)-F:



THIS PRODUCT MANUFACTURED WITH LEAD-FREE PROCESSING

F:\DWG\MISC\MKTG\MCX7-P-C-XX-ST-CA3-MKT.SLDDRW

<p>UNLESS OTHERWISE SPECIFIED, DIMENSIONS ARE IN MILLIMETERS [INCHES]. TOLERANCES ARE:</p> <table border="0"> <tr> <td>DECIMALS</td> <td>ANGLES</td> </tr> <tr> <td>.X: ±0.3 [.01]</td> <td>2°</td> </tr> <tr> <td>.XX: ±0.13 [.005]</td> <td></td> </tr> <tr> <td>.XXX: ±0.051 [.0020]</td> <td></td> </tr> </table>	DECIMALS	ANGLES	.X: ±0.3 [.01]	2°	.XX: ±0.13 [.005]		.XXX: ±0.051 [.0020]		<p>PROPRIETARY NOTE THIS DOCUMENT CONTAINS INFORMATION CONFIDENTIAL AND PROPRIETARY TO SAMTEC, INC. AND SHALL NOT BE REPRODUCED OR TRANSFERRED TO OTHER DOCUMENTS OR DISCLOSED TO OTHERS OR USED FOR ANY PURPOSE OTHER THAN THAT WHICH IT WAS OBTAINED WITHOUT THE EXPRESSED WRITTEN CONSENT OF SAMTEC, INC.</p>	 <p>520 PARK EAST BLVD. NEW ALBANY, IN 47150 PHONE: 812-944-6733 FAX: 812-948-5047 e-Mail: info@SAMTEC.com code 55322</p>
DECIMALS	ANGLES									
.X: ±0.3 [.01]	2°									
.XX: ±0.13 [.005]										
.XXX: ±0.051 [.0020]										
<p>MATERIAL: DO NOT SCALE DRAWING SHEET SCALE: 4:1 SHELL, FERRULES: BRASS CONTACT: BRASS DIELECTRIC: PTFE</p>	<p>DESCRIPTION: MCX STRAIGHT CABLE PLUG, RG179- 75 OHM DWG. NO. MCX7-P-C-XX-ST-CA3 BY: R MUSSER 02/06/2008 SHEET 1 OF 3</p>									

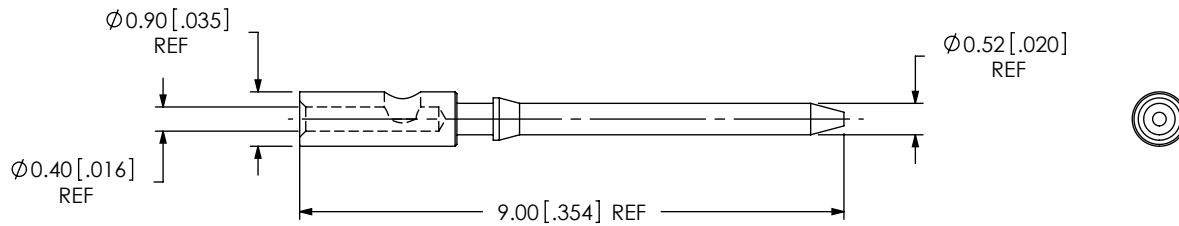

SAMTEC PART NUMBER	ITEM
MCX7-P-C-X-ST-CA3-PIN	PIN

SCALE 8:1

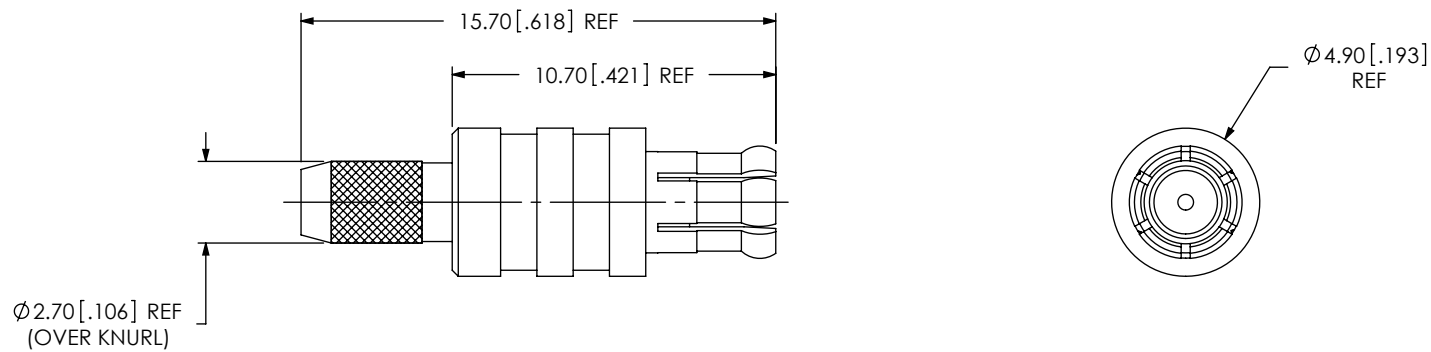

SAMTEC PART NUMBER	ITEM
SUB-MCX7-P-C-XX-ST-CA3	SUB ASSEMBLY

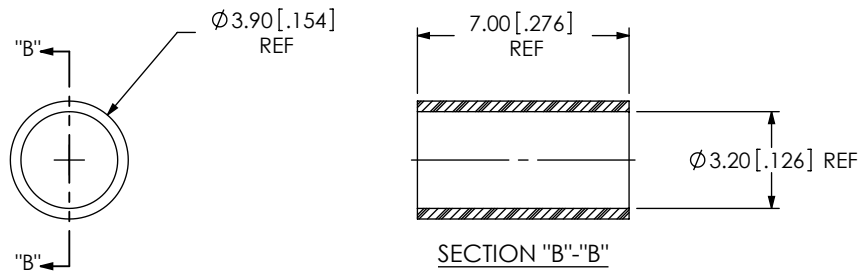

SAMTEC PART NUMBER	ITEM
MCX-FER-001-X	OUTER FERRULE

F:\DWG\MISC\MKTG\MCX7-P-C-XX-ST-CA3-MKT.SLDDRW

PROPRIETARY NOTE

THIS DOCUMENT CONTAINS INFORMATION CONFIDENTIAL AND PROPRIETARY TO SAMTEC, INC. AND SHALL NOT BE REPRODUCED OR TRANSFERRED TO OTHER DOCUMENTS OR DISCLOSED TO OTHERS OR USED FOR ANY PURPOSE OTHER THAN THAT WHICH IT WAS OBTAINED WITHOUT THE EXPRESSED WRITTEN CONSENT OF SAMTEC, INC.

DO NOT SCALE DRAWING

SHEET SCALE: 4:1



520 PARK EAST BLVD, NEW ALBANY, IN 47150
 PHONE: 812-944-6733 FAX: 812-948-5047
 e-Mail info@SAMTEC.com code 55322

DESCRIPTION:
 MCX STRAIGHT CABLE PLUG, RG179- 75 OHM

DWG. NO.
MCX7-P-C-XX-ST-CA3

BY: R MUSSER 02/06/2008 SHEET 2 OF 3

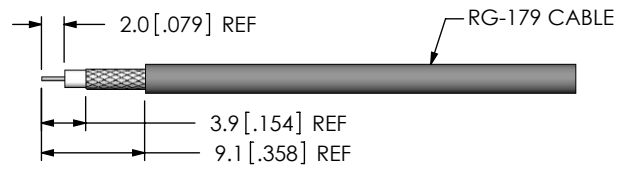

STRIP AND TIN INNER CONDUCTOR

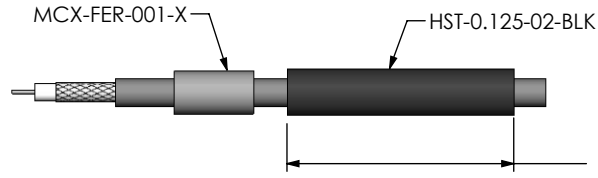

ADD HEAT SHRINK TUBE AND FERRULE

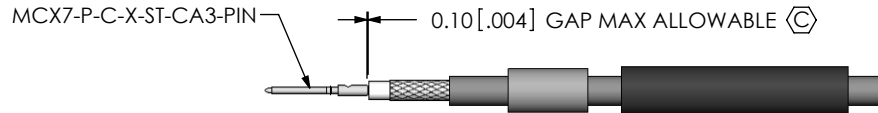

SOLDER SIGNAL PIN

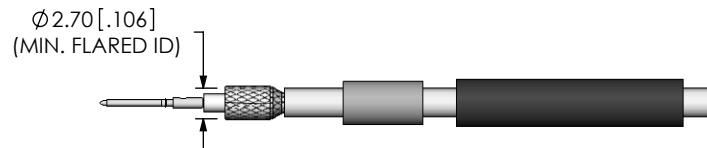

FLARE SHIELD

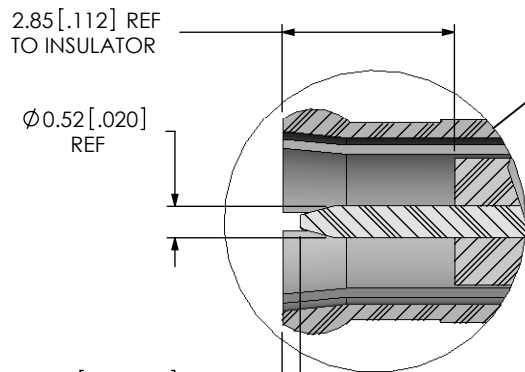

DETAIL 'A'
SCALE 8:1

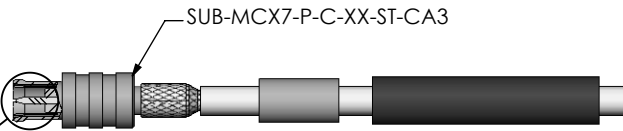

ADD SUB-MCX7-P-C-XX-ST-CA3

CRIMP FERRULE
(USE RF CRIMP HAND TOOL # CAT-HT-T26667-21 OR EQUIVALENT)

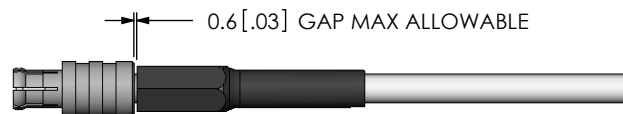
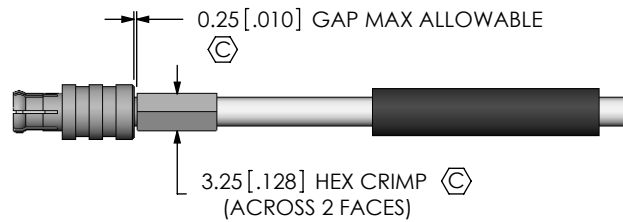

APPLY HEAT SHRINK TUBING

F:\DWG\MISC\MKTG\MCX7-P-C-XX-ST-CA3-MKT.SLDDRW

PROPRIETARY NOTE

THIS DOCUMENT CONTAINS INFORMATION CONFIDENTIAL AND PROPRIETARY TO SAMTEC, INC. AND SHALL NOT BE REPRODUCED OR TRANSFERRED TO OTHER DOCUMENTS OR DISCLOSED TO OTHERS OR USED FOR ANY PURPOSE OTHER THAN THAT WHICH IT WAS OBTAINED WITHOUT THE EXPRESSED WRITTEN CONSENT OF SAMTEC, INC.

DO NOT SCALE DRAWING

SHEET SCALE: 1:5:1



520 PARK EAST BLVD, NEW ALBANY, IN 47150
PHONE: 812-944-6733 FAX: 812-948-5047
e-Mail info@SAMTEC.com code 55322

DESCRIPTION:
MCX STRAIGHT CABLE PLUG, RG179- 75 OHM

DWG. NO.
MCX7-P-C-XX-ST-CA3

BY: R MUSSER 02/06/2008 SHEET 3 OF 3