

Dual 2.3GHz to 4.5GHz High Dynamic Range Downconverting Mixer

FEATURES

- Conversion Gain: 8.5dB at 2500MHz
- IIP3: 27.7dBm at 2500MHz
- Noise Figure: 9.5dB at 2500MHz
- 15.9dB NF Under 5dBm Blocking
- High Input P1dB
- 52dB Channel Isolation at 2500MHz
- 3.3V Supply, 1.3W Power Consumption
- Low Power Mode for 0.8W Consumption
- Independent Channel Shutdown Control
- 50Ω Single-Ended RF and LO Inputs
- LO Input Matched In All Modes
- 0dBm LO Drive Level
- -40°C to 105°C Operation
- Small QFN (5mm × 5mm) Package and Solution Size

APPLICATIONS

- Wireless Infrastructure Diversity Receivers (LTE, WiMAX)
- Transmit DPD Receivers
- MIMO Infrastructure Receivers
- Broadband Microwave Receivers

LT, LT, LTC, LTM, Linear Technology and the Linear logo are registered trademarks of Linear Technology Corporation. All other trademarks are the property of their respective owners.

DESCRIPTION

The LTC[®]5593 is part of a family of dual-channel high dynamic range, high gain downconverting mixers covering the 600MHz to 4.5GHz RF frequency range. **The LTC5593 is optimized for 2.3GHz to 4.5GHz RF applications. The LO frequency must fall within the 2.1GHz to 4.2GHz range for optimum performance.** A typical application is a LTE or WiMAX multichannel or diversity receiver with a 2.3GHz to 2.7GHz RF input.

The LTC5593's high conversion gain and high dynamic range enable the use of lossy IF filters in high selectivity receiver designs, while minimizing the total solution cost, board space and system-level variation. A low current mode is provided for additional power savings and each of the mixer channels has independent shutdown control.

High Dynamic Range Dual Downconverting Mixer Family

PART NUMBER	RF RANGE	LO RANGE
LTC5590	600MHz to 1.7GHz	700MHz to 1.5GHz
LTC5591	1.3GHz to 2.3GHz	1.4GHz to 2.1GHz
LTC5592	1.6GHz to 2.7GHz	1.7GHz to 2.5GHz
LTC5593	2.3GHz to 4.5GHz	2.1GHz to 4.2GHz

TYPICAL APPLICATION

LTE Diversity Receiver

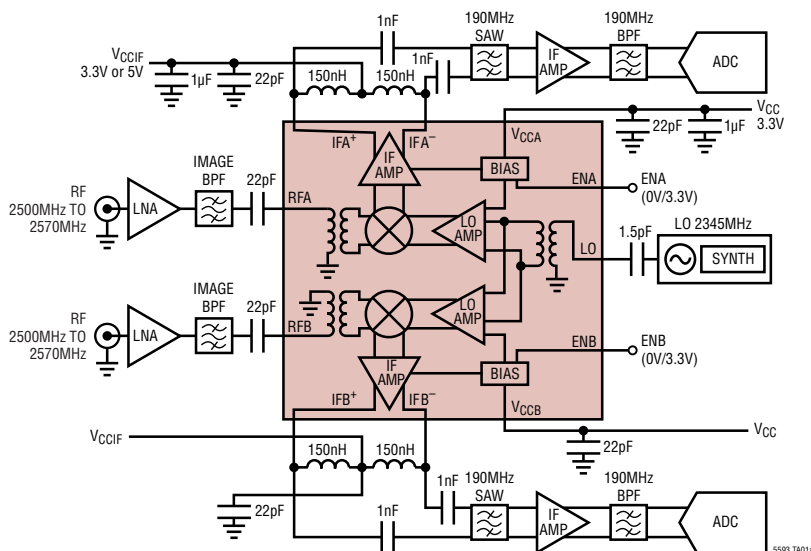

Wideband Conversion Gain, IIP3 and NF vs IF Frequency
(LTC5593 Only, Measured on Evaluation Board)

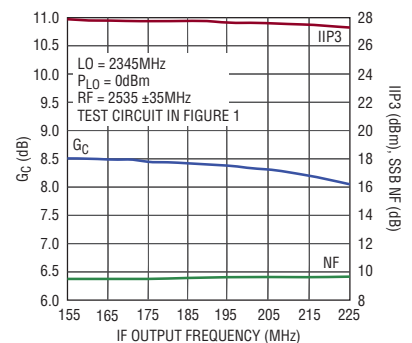

ABSOLUTE MAXIMUM RATINGS

(Note 1)

Supply Voltage (V_{CC})	4.0V
IF Supply Voltage (V_{CCIF})	5.5V
Enable Voltage (ENA, ENB)	-0.3V to $V_{CC} + 0.3V$
Bias Adjust Voltage (IFBA, IFBB)	-0.3V to $V_{CC} + 0.3V$
Power Select Voltage (I_{SEL})	-0.3V to $V_{CC} + 0.3V$
LO Input Power (2GHz to 5GHz)	9dBm
LO Input DC Voltage	$\pm 0.1V$
RFA, RFB Input Power (2GHz to 5GHz)	15dBm
RFA, RFB Input DC Voltage	$\pm 0.1V$
Operating Temperature Range (T_C)	-40°C to 105°C
Storage Temperature Range	-65°C to 150°C
Junction Temperature (T_J)	150°C

PIN CONFIGURATION

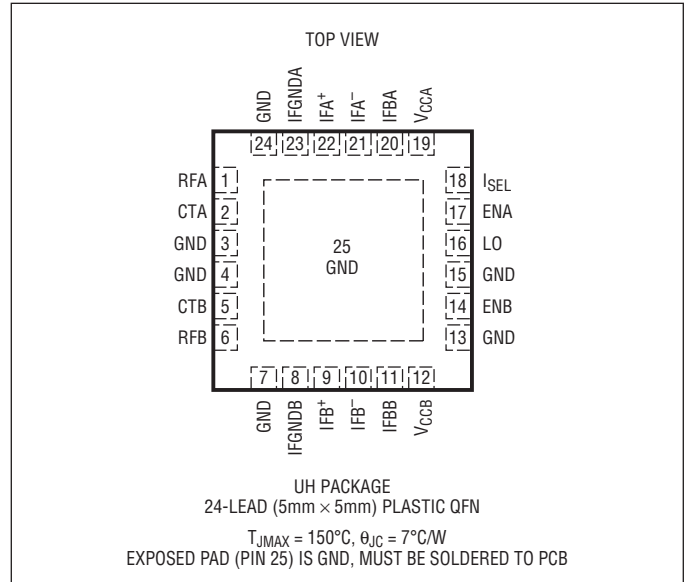

ORDER INFORMATION

LEAD FREE FINISH	TAPE AND REEL	PART MARKING	PACKAGE DESCRIPTION	TEMPERATURE RANGE
LTC5593IUH#PBF	LTC5593IUH#TRPBF	5593	24-Lead (5mm × 5mm) Plastic QFN	-40°C to 105°C

Consult LTC Marketing for parts specified with wider operating temperature ranges.

Consult LTC Marketing for information on non-standard lead based finish parts.

For more information on lead free part marking, go to: <http://www.linear.com/leadfree/>

For more information on tape and reel specifications, go to: <http://www.linear.com/tapeandreel/>

DC ELECTRICAL CHARACTERISTICS

$V_{CC} = 3.3V$, $V_{CCIF} = 3.3V$, $ENA = ENB = \text{high}$, $I_{SEL} = \text{low}$, $T_C = 25^\circ C$, unless otherwise noted. Test circuit shown in Figure 1. (Note 2)

PARAMETER	CONDITIONS	MIN	TYP	MAX	UNITS
Power Supply Requirements (V_{CCA}, V_{CCB}, V_{CCIFA}, V_{CCIFB})					
V_{CCA} , V_{CCB} Supply Voltage (Pins 12, 19)		3.1	3.3	3.5	V
V_{CCIFA} , V_{CCIFB} Supply Voltage (Pins 9, 10, 21, 22)		3.1	3.3	5.3	V
Mixer Supply Current (Pins 12, 19)	Both Channels Enabled		196	242	mA
IF Amplifier Supply Current (Pins 9, 10, 21, 22)	Both Channels Enabled		200	251	mA
Total Supply Current (Pins 9, 10, 12, 19, 21, 22)	Both Channels Enabled		396	493	mA
Total Supply Current – Shutdown	$ENA = ENB = \text{Low}$			500	μA
Enable Logic Input (ENA, ENB) High = On, Low = Off					
ENA , ENB Input High Voltage (On)		2.5			V
ENA , ENB Input Low Voltage (Off)				0.3	V
ENA , ENB Input Current	$-0.3V$ to $V_{CC} + 0.3V$	-20		30	μA
Turn-On Time			0.9		μs
Turn-Off Time			1.0		μs
Low Power Mode Logic Input (I_{SEL}) High = Low Power, Low = Normal Power Mode					
I_{SEL} Input High Voltage		2.5			V
I_{SEL} Input Low Voltage				0.3	V
I_{SEL} Input Current	$-0.3V$ to $V_{CC} + 0.3V$	-20		30	μA
Low Power Mode Current Consumption ($I_{SEL} = \text{High}$)					
Mixer Supply Current (Pins 12, 19)	Both Channels Enabled		127	159	mA
IF Amplifier Supply Current (Pins 9, 10, 21, 22)	Both Channels Enabled		120	157	mA
Total Supply Current (Pins 9, 10, 12, 19, 21, 22)	Both Channels Enabled		247	316	mA

AC ELECTRICAL CHARACTERISTICS

$V_{CC} = 3.3V$, $V_{CCIF} = 3.3V$, $ENA = ENB = \text{high}$, $I_{SEL} = \text{low}$, $T_C = 25^\circ\text{C}$,
 $P_{LO} = 0\text{dBm}$, $P_{RF} = -3\text{dBm}$ ($\Delta f = 2\text{MHz}$ for two tone IIP3 tests), unless otherwise noted. Test circuit shown in Figure 1. (Notes 2, 3, 4)

PARAMETER	CONDITIONS	MIN	TYP	MAX	UNITS
LO Input Frequency Range		2100 to 3800			MHz
RF Input Frequency Range	Low Side LO High Side LO	2300 to 4000 2300 to 4000			MHz MHz
IF Output Frequency Range	Requires External Matching	5 to 600			MHz
RF Input Return Loss	$Z_0 = 50\Omega$, 2200MHz to 3800MHz	>12			dB
LO Input Return Loss	$Z_0 = 50\Omega$, 2400MHz to 3600MHz	>12			dB
IF Output Impedance	Differential at 190MHz	274 Ω 2.4pF			R C
LO Input Power	$f_{LO} = 2100\text{MHz}$ to 3800MHz	-4	0	6	dBm
LO to RF Leakage	$f_{LO} = 2100\text{MHz}$ to 3800MHz	<-33			dBm
LO to IF Leakage	$f_{LO} = 2100\text{MHz}$ to 3800MHz	<-30			dBm
RF to LO Isolation	$f_{RF} = 2300\text{MHz}$ to 4000MHz	>44			dB
RF to IF Isolation	$f_{RF} = 2300\text{MHz}$ to 4000MHz	>38			dB
Channel-to-Channel Isolation	$f_{RF} = 2500\text{MHz}$ $f_{RF} = 3500\text{MHz}$	52 44			dB dB

Low Side LO Downmixer Application: $I_{SEL} = \text{Low}$, $IF = 190\text{MHz}$, $f_{LO} = f_{RF} - f_{IF}$

PARAMETER	CONDITIONS	MIN	TYP	MAX	UNITS
Conversion Gain	RF = 2300MHz RF = 2500MHz RF = 2700MHz RF = 3200MHz RF = 3500MHz RF = 3800MHz	6.8	9.0 8.5 8.0 8.1 7.6 7.0		dB dB dB dB dB dB
Conversion Gain Flatness	RF = 2500 \pm 30MHz, LO = 2310MHz, IF = 190 \pm 30MHz	\pm 0.25			dB
Conversion Gain vs Temperature	$T_C = -40^\circ\text{C}$ to 105°C , RF = 2500MHz	-0.008			dB/ $^\circ\text{C}$
Input 3rd Order Intercept	RF = 2300MHz RF = 2500MHz RF = 2700MHz RF = 3200MHz RF = 3500MHz RF = 3800MHz	24.0	26.1 27.7 27.6 26.5 26.0 26.1		dBm dBm dBm dBm dBm dBm
SSB Noise Figure	RF = 2300MHz RF = 2500MHz RF = 2700MHz RF = 3200MHz RF = 3500MHz RF = 3800MHz		9.4 9.5 9.7 11.2 11.3 12.0		dB dB dB dB dB dB
SSB Noise Figure Under Blocking	$f_{RF} = 2500\text{MHz}$, $f_{LO} = 2310\text{MHz}$, $f_{BLOCK} = 2600\text{MHz}$, $P_{BLOCK} = 5\text{dBm}$ $P_{BLOCK} = 8\text{dBm}$		15.9 19.4		dB dB
2RF-2LO Output Spurious Product ($f_{RF} = f_{LO} + f_{IF}/2$)	$f_{RF} = 2405\text{MHz}$ at -10dBm , $f_{LO} = 2310\text{MHz}$, $f_{IF} = 190\text{MHz}$		-64		dBc
3RF-3LO Output Spurious Product ($f_{RF} = f_{LO} + f_{IF}/3$)	$f_{RF} = 2373.3\text{MHz}$ at -10dBm , $f_{LO} = 2310\text{MHz}$, $f_{IF} = 190\text{MHz}$		-70		dBc
Input 1dB Compression	$f_{RF} = 2500\text{MHz}$, $V_{CCIF} = 3.3V$ $f_{RF} = 2500\text{MHz}$, $V_{CCIF} = 5V$		10.4 13.7		dBm dBm

AC ELECTRICAL CHARACTERISTICS

$V_{CC} = 3.3V$, $V_{CCIF} = 3.3V$, $ENA = ENB = \text{high}$, $T_C = 25^\circ\text{C}$, $P_{LO} = 0\text{dBm}$, $P_{RF} = -3\text{dBm}$ ($\Delta f = 2\text{MHz}$ for 2-tone IIP3 tests), unless otherwise noted. Test circuit shown in Figure 1. (Notes 2, 3)

Low Power Mode, Low Side LO Downmixer Application: $I_{SEL} = \text{High}$, $IF = 190\text{MHz}$, $f_{LO} = f_{RF} - f_{IF}$

PARAMETER	CONDITIONS	MIN	TYP	MAX	UNITS
Conversion Gain	RF = 2500MHz		7.8		dB
	RF = 3500MHz		6.3		dB
Input 3rd Order Intercept	RF = 2500MHz		21.6		dBm
	RF = 3500MHz		21.0		dBm
SSB Noise Figure	RF = 2500MHz		9.2		dB
	RF = 3500MHz		11.5		dB
Input 1dB Compression	RF = 2500MHz, $V_{CCIF} = 3.3V$		10.0		dBm
	RF = 2500MHz, $V_{CCIF} = 5V$		10.7		dBm

High Side LO Downmixer Application: $I_{SEL} = \text{Low}$, $IF = 190\text{MHz}$, $f_{LO} = f_{RF} + f_{IF}$

PARAMETER	CONDITIONS	MIN	TYP	MAX	UNITS
Conversion Gain	RF = 2300MHz		8.7		dB
	RF = 2500MHz		8.4		dB
	RF = 2700MHz		8.0		dB
	RF = 3200MHz		7.7		dB
	RF = 3500MHz		7.2		dB
	RF = 3800MHz		6.8		dB
Conversion Gain Flatness	RF = 2500 \pm 30MHz, LO = 2690MHz, IF = 190 \pm 30MHz		\pm 0.1		dB
Conversion Gain vs Temperature	$T_C = -40^\circ\text{C}$ to 105°C , RF = 2500MHz		-0.006		dB/ $^\circ\text{C}$
Input 3rd Order Intercept	RF = 2300MHz		25.1		dBm
	RF = 2500MHz		25.5		dBm
	RF = 2700MHz		25.9		dBm
	RF = 3200MHz		24.5		dBm
	RF = 3500MHz		24.2		dBm
	RF = 3800MHz		23.8		dBm
SSB Noise Figure	RF = 2300MHz		10.0		dB
	RF = 2500MHz		10.5		dB
	RF = 2700MHz		10.6		dB
	RF = 3200MHz		11.1		dB
	RF = 3500MHz		12.1		dB
	RF = 3800MHz		12.1		dB
SSB Noise Figure Under Blocking	$f_{RF} = 2500\text{MHz}$, $f_{LO} = 2690\text{MHz}$, $f_{BLOCK} = 2400\text{MHz}$, $P_{BLOCK} = 5\text{dBm}$		17.8		dB
	$P_{BLOCK} = 8\text{dBm}$		21.8		dB
2LO-2RF Output Spurious Product ($f_{RF} = f_{LO} - f_{IF}/2$)	$f_{RF} = 2595\text{MHz}$ at -10dBm , $f_{LO} = 2690\text{MHz}$, $f_{IF} = 190\text{MHz}$		-66		dBc
3LO-3RF Output Spurious Product ($f_{RF} = f_{LO} - f_{IF}/3$)	$f_{RF} = 2626.67\text{MHz}$ at -10dBm , $f_{LO} = 2690\text{MHz}$, $f_{IF} = 190\text{MHz}$		-75		dBc
Input 1dB Compression	RF = 2500MHz, $V_{CCIF} = 3.3V$		10.7		dBm
	RF = 2500MHz, $V_{CCIF} = 5V$		14.1		dBm

AC ELECTRICAL CHARACTERISTICS

$V_{CC} = 3.3V$, $V_{CCIF} = 3.3V$, $ENA = ENB = High$, $T_C = 25^\circ C$, $P_{LO} = 0dBm$, $P_{RF} = -3dBm$ ($\Delta f = 2MHz$ for two tone IIP3 tests), unless otherwise noted. Test circuit shown in Figure 1. (Notes 2, 3)

Low Power Mode, High Side LO Downmixer Application: $I_{SEL} = High$, $IF = 190MHz$, $f_{LO} = f_{RF} + f_{IF}$

PARAMETER	CONDITIONS	MIN	TYP	MAX	UNITS
Conversion Gain	RF = 2500MHz		7.4		dB
	RF = 3500MHz		5.9		dB
Input 3rd Order Intercept	RF = 2500MHz		22.1		dBm
	RF = 3500MHz		20.2		dBm
SSB Noise Figure	RF = 2500MHz		10.6		dB
	RF = 3500MHz		12.4		dB
Input 1dB Compression	RF = 2500MHz, $V_{CCIF} = 3.3V$		10.9		dBm
	RF = 2500MHz, $V_{CCIF} = 5V$		11.7		dBm

Note 1: Stresses beyond those listed under Absolute Maximum Ratings may cause permanent damage to the device. Exposure to any Absolute Maximum Rating condition for extended periods may affect device reliability and lifetime.

Note 2: The LTC5593 is guaranteed functional over the case operating temperature range of $-40^\circ C$ to $105^\circ C$. ($\theta_{JC} = 7^\circ C/W$)

Note 3: SSB Noise Figure measured with a small-signal noise source, bandpass filter and 6dB matching pad on RF input, bandpass filter and 6dB matching pad on the LO input, and no other RF signals applied.

Note 4: Channel A to channel B isolation is measured as the relative IF output power of channel B to channel A, with the RF input signal applied to channel A. The RF input of channel B is 50Ω terminated and both mixers are enabled.

TYPICAL AC PERFORMANCE CHARACTERISTICS 2.3GHz to 2.7GHz, low side LO.

$V_{CC} = 3.3V$, $V_{CCIF} = 3.3V$, ENA = ENB = high, $I_{SEL} = \text{low}$, $T_C = 25^\circ\text{C}$, $P_{LO} = 0\text{dBm}$, $P_{RF} = -3\text{dBm}$ ($-3\text{dBm}/\text{tone}$ for 2-tone IIP3 tests, $\Delta f = 2\text{MHz}$), $IF = 190\text{MHz}$, unless otherwise noted. Test circuit shown in Figure 1.

Conversion Gain and IIP3 vs RF Frequency

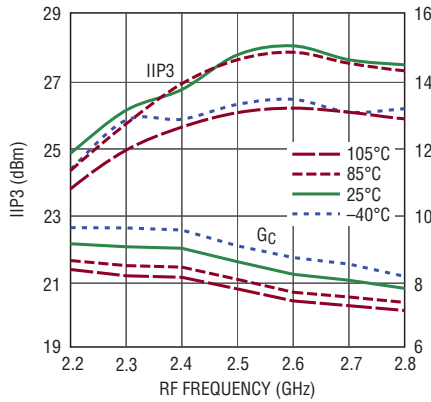

5593 G01

SSB NF vs RF Frequency

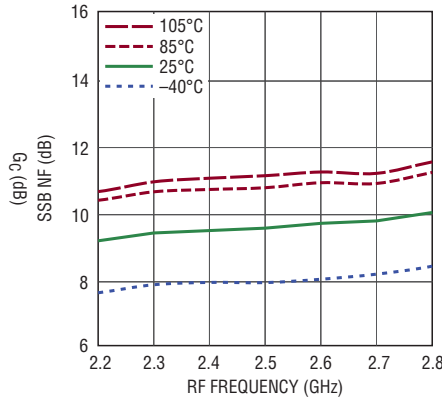

5593 G02

Channel Isolation vs RF Frequency

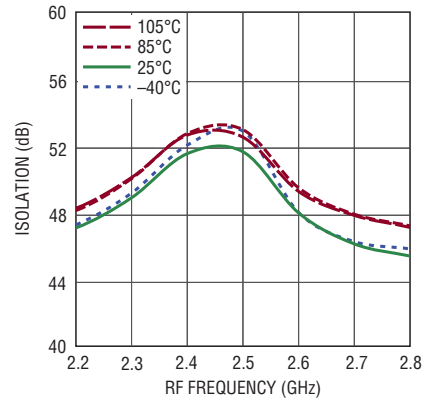

5593 G03

2300MHz Conversion Gain, IIP3 and NF vs LO Power

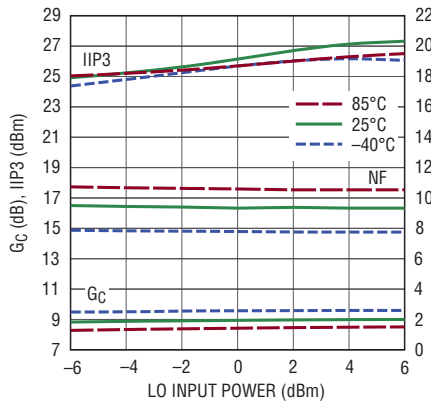

5593 G04

2500MHz Conversion Gain, IIP3 and NF vs LO Power

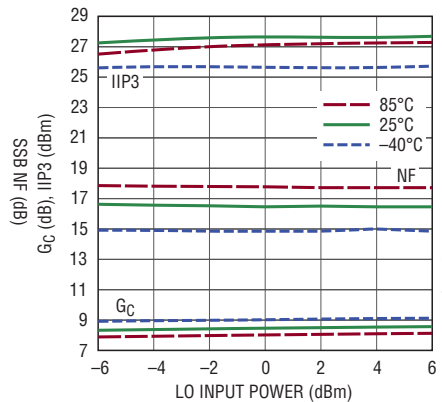

5593 G05

2700MHz Conversion Gain, IIP3 and NF vs LO Power

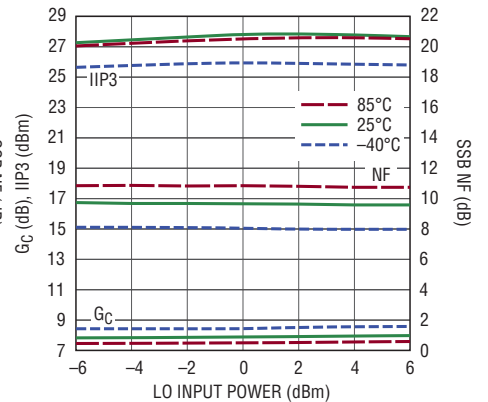

5593 G06

Conversion Gain, IIP3 and NF vs Supply Voltage (Single Supply)

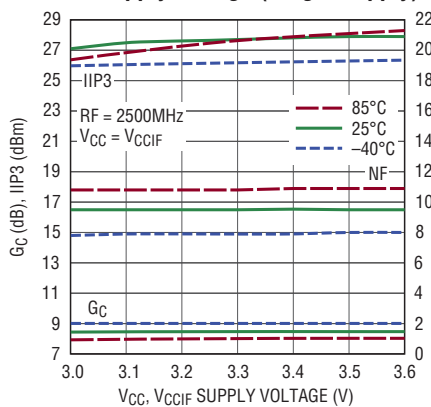

5593 G07

Conversion Gain, IIP3 and NF vs IF Supply Voltage (Dual Supply)

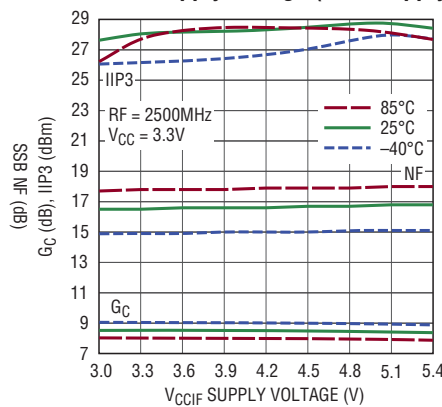

5593 G08

Conversion Gain, IIP3 and RF Input P1dB vs Temperature

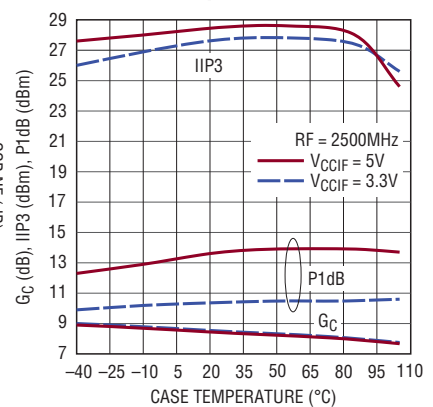

5593 G09

TYPICAL AC PERFORMANCE CHARACTERISTICS 2.3GHz to 2.7GHz, low side LO (continued).

$V_{CC} = 3.3V$, $V_{CCIF} = 3.3V$, ENA = ENB = High, $I_{SEL} = \text{low}$, $T_C = 25^\circ C$, $P_{LO} = 0\text{dBm}$, $P_{RF} = -3\text{dBm}$ (-3dBm/tone for 2-tone IIP3 tests, $\Delta f = 2\text{MHz}$), $I_F = 190\text{MHz}$, unless otherwise noted. Test circuit shown in Figure 1.

2-Tone IF Output Power, IM3 and IM5 vs RF Input Power

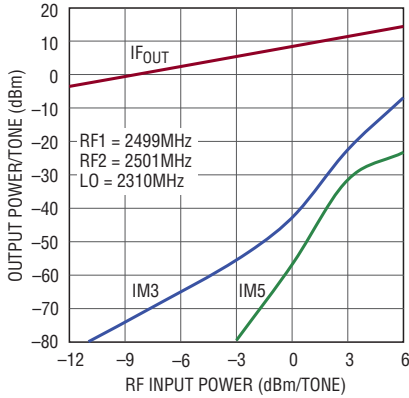

5593 G10

Single-Tone IF Output Power, 2 x 2 and 3 x 3 Spurs vs RF Input Power

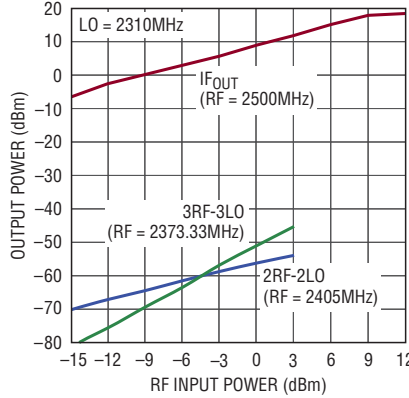

5593 G11

2 x 2 and 3 x 3 Spurs vs RF Frequency

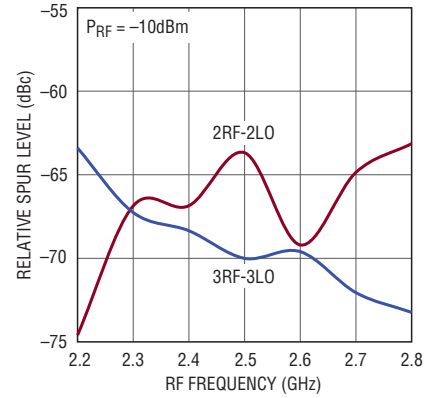

5593 G12

SSB Noise Figure vs RF Blocker Level

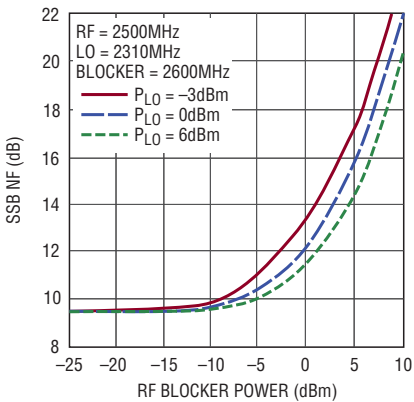

5593 G13

LO Leakage vs LO Frequency

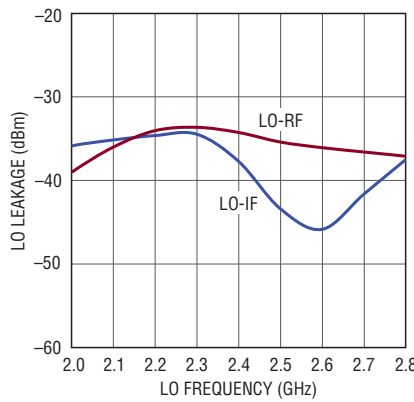

5593 G14

RF Isolation vs RF Frequency

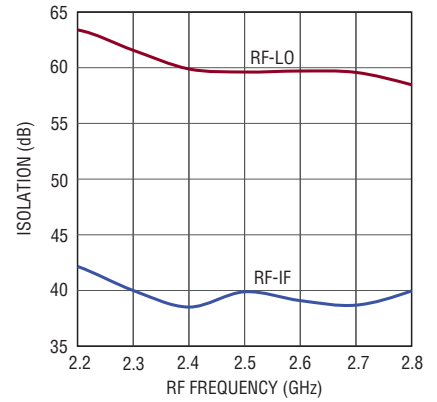

5593 G15

Conversion Gain Distribution

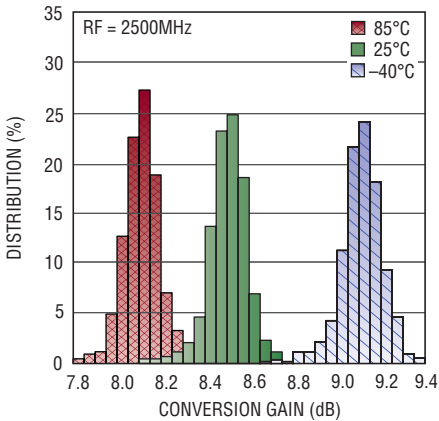

5593 G16

IIP3 Distribution

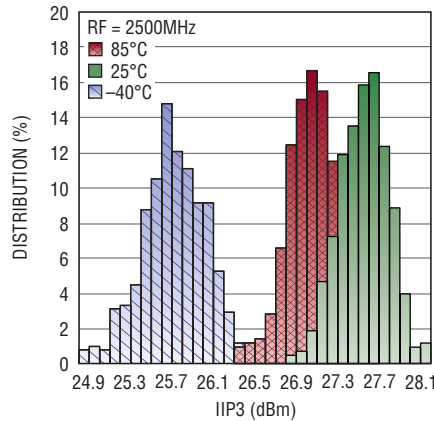

5593 G17

SSB Noise Figure Distribution

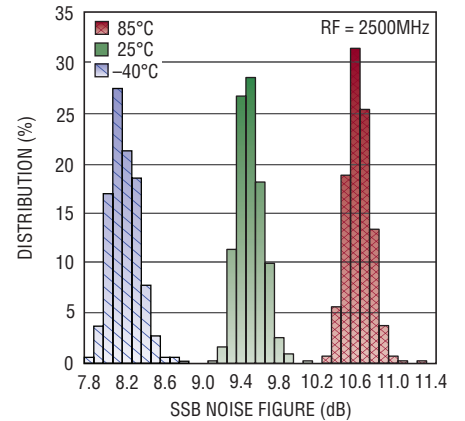

5593 G18

TYPICAL AC PERFORMANCE CHARACTERISTICS

2.3GHz to 2.7GHz, low side LO, I_{SEL} = high (low power mode). V_{CC} = 3.3V, V_{CCIF} = 3.3V, ENA = ENB = High, T_C = 25°C, P_{LO} = 0dBm, P_{RF} = -3dBm (-3dBm/tone for 2-tone IIP3 tests, Δf = 2MHz), IF = 190MHz, unless otherwise noted. Test circuit shown in Figure 1.

Conversion Gain and IIP3 vs RF Frequency

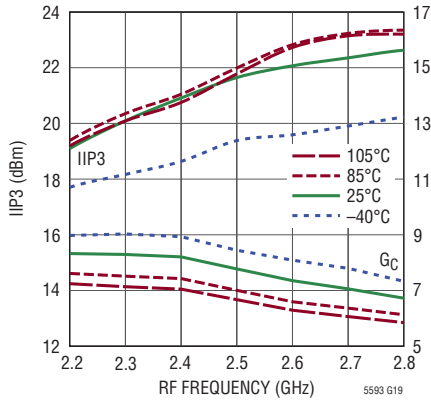

SSB NF vs RF Frequency

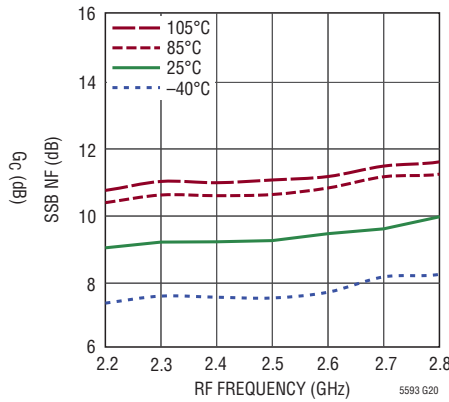

Channel Isolation vs RF Frequency

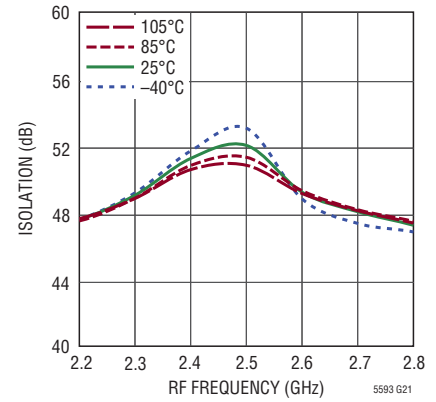

2300MHz Conversion Gain, IIP3 and NF vs LO Power

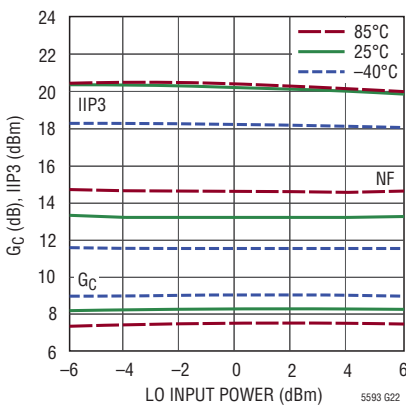

2500MHz Conversion Gain, IIP3 and NF vs LO Power

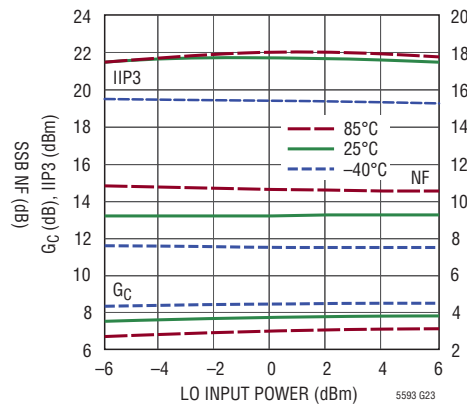

2700MHz Conversion Gain, IIP3 and NF vs LO Power

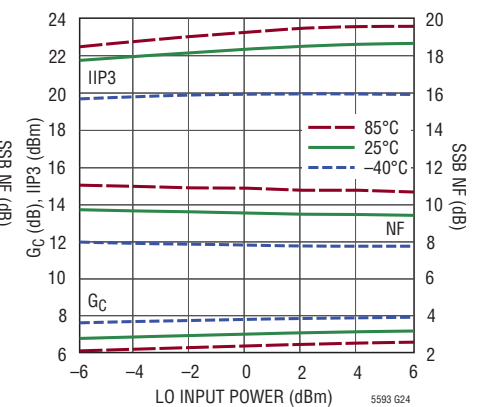

Conversion Gain, IIP3 and NF vs Supply Voltage (Single Supply)

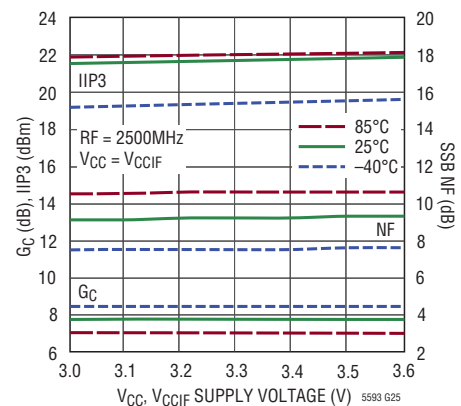

Conversion Gain, IIP3 and RF Input P1dB vs Temperature

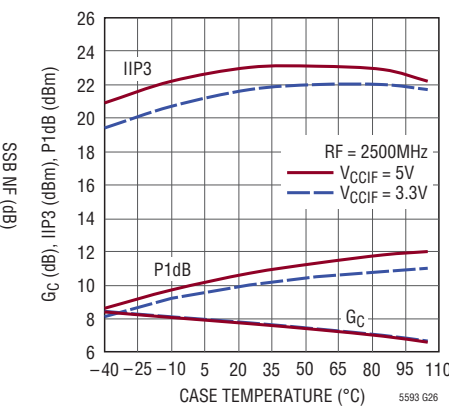

RF Isolation and LO Leakage vs Frequency

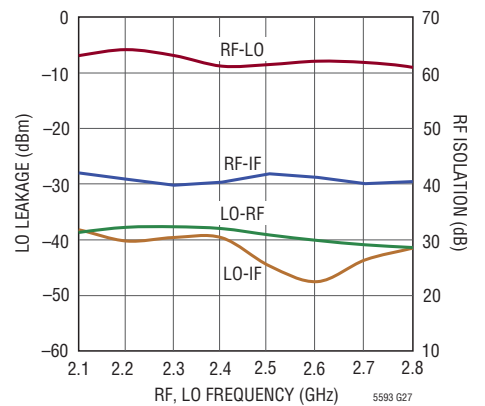

TYPICAL AC PERFORMANCE CHARACTERISTICS

2.3GHz to 2.7GHz, high side LO. $V_{CC} = 3.3V$, $V_{CCIF} = 3.3V$, ENA = ENB = high, $I_{SEL} = \text{low}$, $T_C = 25^\circ C$, $P_{LO} = 0dBm$, $P_{RF} = -3dBm$ (-3dBm/tone for 2-tone IIP3 tests, $\Delta f = 2MHz$), IF = 190MHz, unless otherwise noted. Test circuit shown in Figure 1.

Conversion Gain and IIP3 vs RF Frequency

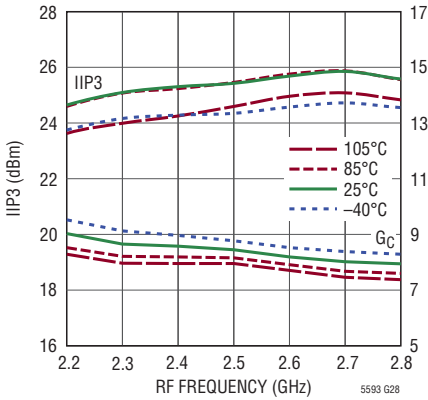

SSB NF vs RF Frequency

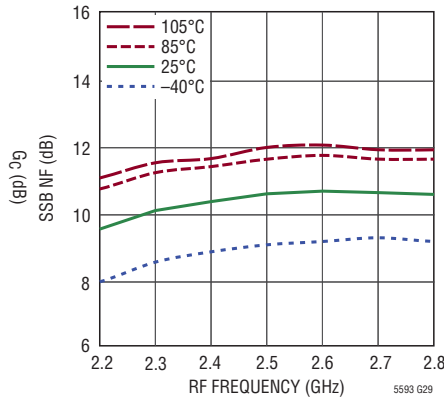

Channel Isolation vs RF Frequency

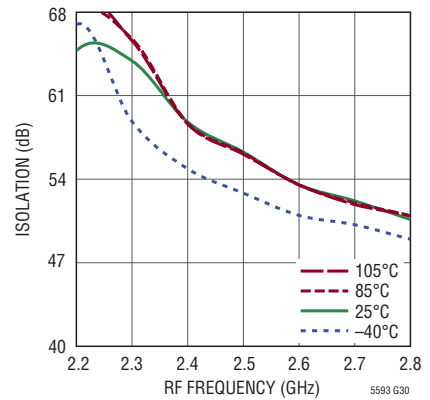

2300MHz Conversion Gain, IIP3 and NF vs LO Power

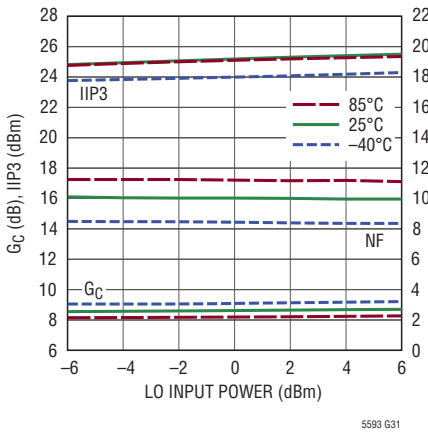

2500MHz Conversion Gain, IIP3 and NF vs LO Power

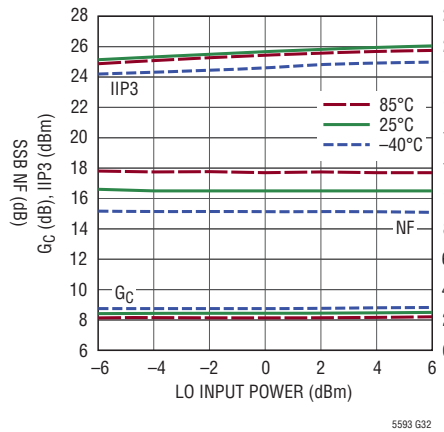

2700MHz Conversion Gain, IIP3 and NF vs LO Power

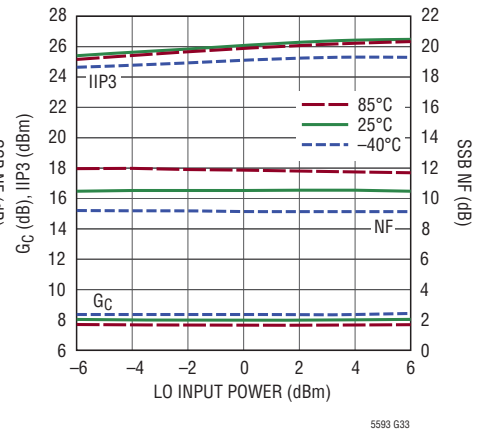

Conversion Gain, IIP3 and NF vs Supply Voltage (Single Supply)

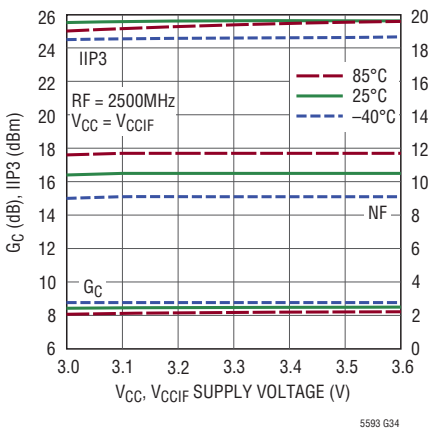

Conversion Gain, IIP3 and RF Input P1dB vs Temperature

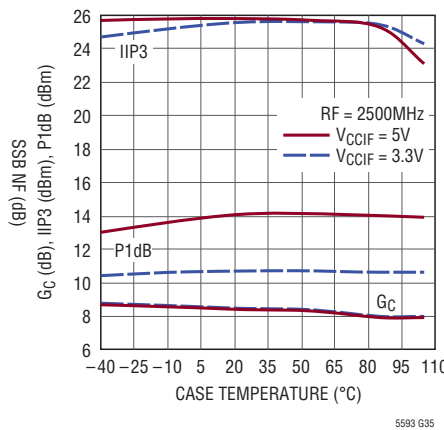

RF Isolation and LO Leakage vs Frequency

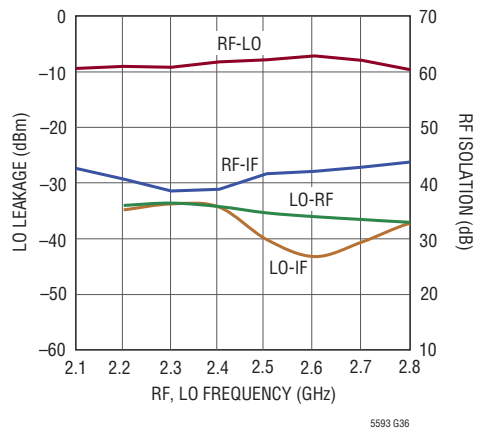

TYPICAL AC PERFORMANCE CHARACTERISTICS

2.3GHz to 2.7GHz, high side LO, I_{SEL} = high (low power mode). V_{CC} = 3.3V, V_{CCIF} = 3.3V, ENA = ENB = high, T_C = 25°C, P_{LO} = 0dBm, P_{RF} = -3dBm (-3dBm/tone for 2-tone IIP3 tests, Δf = 2MHz), IF = 190MHz, unless otherwise noted. Test circuit shown in Figure 1.

Conversion Gain and IIP3 vs RF Frequency

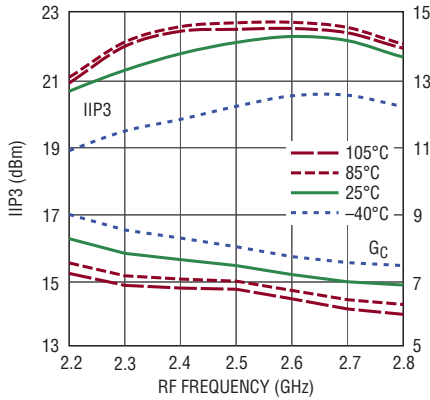

5593 G37

SSB NF vs RF Frequency

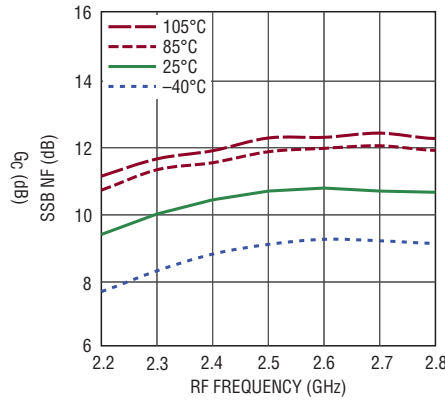

5593 G38

Channel Isolation vs RF Frequency

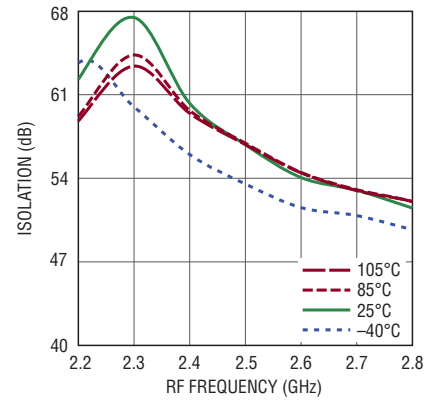

5593 G39

2300MHz Conversion Gain, IIP3 and NF vs LO Power

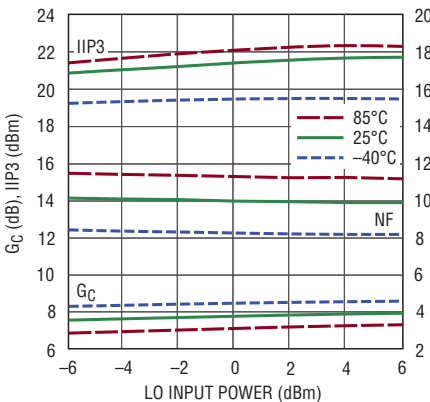

5593 G40

2500MHz Conversion Gain, IIP3 and NF vs LO Power

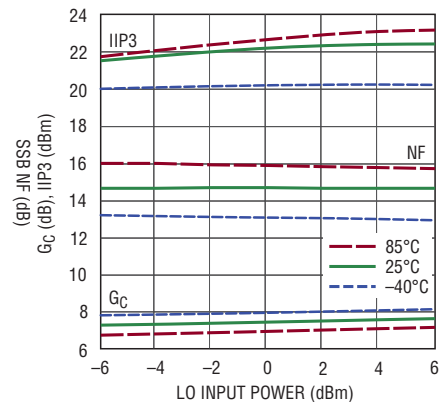

5593 G41

2700MHz Conversion Gain, IIP3 and NF vs LO Power

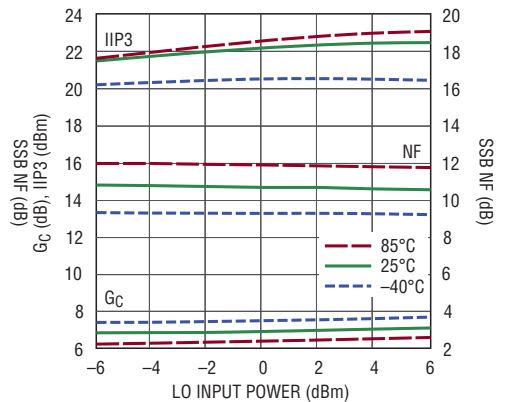

5593 G42

Conversion Gain, IIP3 and NF vs Supply Voltage (Single Supply)

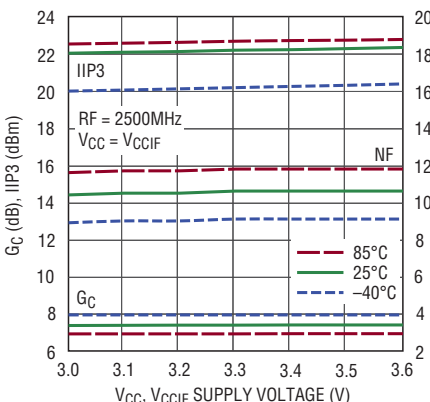

5593 G43

Conversion Gain, IIP3 and RF Input P1dB vs Temperature

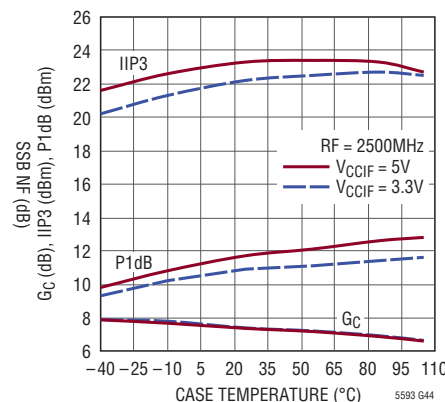

5593 G44

RF Isolation and LO Leakage vs Frequency

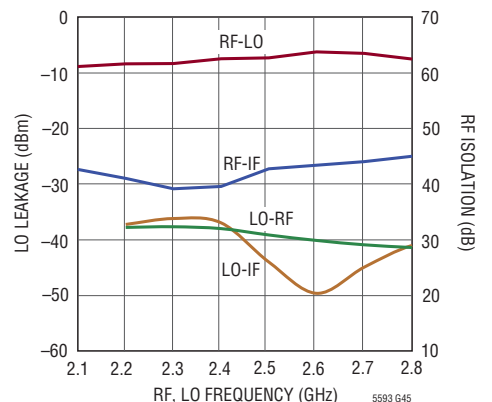

5593 G45

TYPICAL AC PERFORMANCE CHARACTERISTICS

2.7GHz to 4GHz, low side LO. $V_{CC} = 3.3V$, $V_{CCIF} = 3.3V$, ENA = ENB = high, $I_{SEL} = \text{low}$, $T_C = 25^\circ C$, $P_{LO} = 0\text{dBm}$, $P_{RF} = -3\text{dBm}$ (-3dBm/tone for 2-tone IIP3 tests, $\Delta f = 2\text{MHz}$), IF = 190MHz, unless otherwise noted. Test circuit shown in Figure 1.

Conversion Gain and IIP3 vs RF Frequency

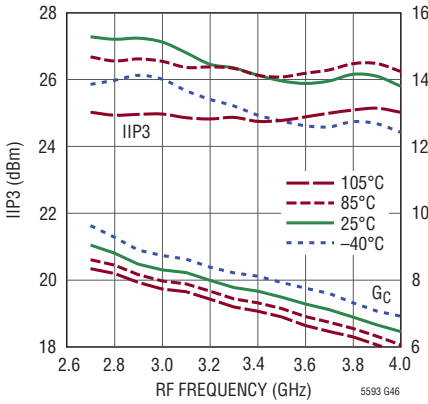

SSB NF vs RF Frequency

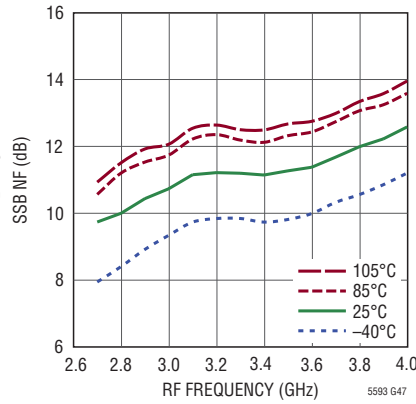

Channel Isolation vs RF Frequency

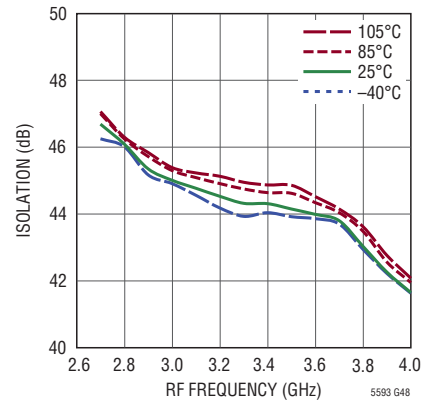

3200MHz Conversion Gain, IIP3 and NF vs LO Power

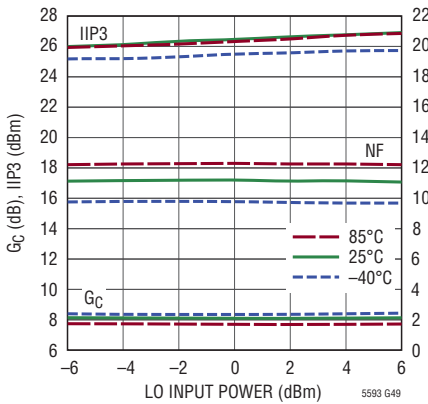

3500MHz Conversion Gain, IIP3 and NF vs LO Power

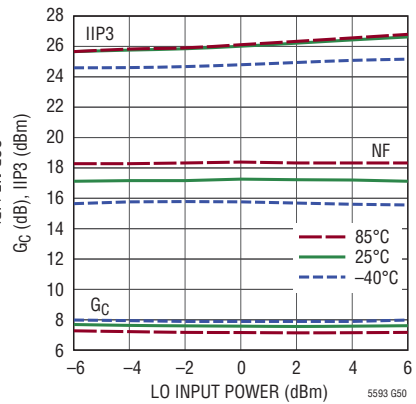

3800MHz Conversion Gain, IIP3 and NF vs LO Power

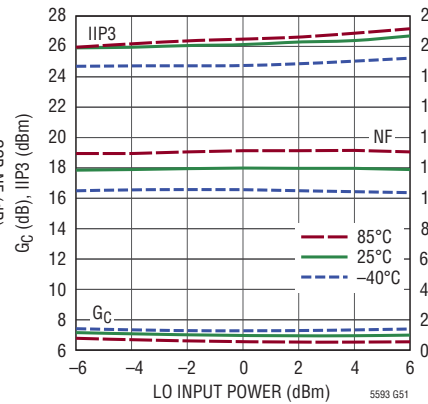

Conversion Gain, IIP3 and NF vs Supply Voltage (Single Supply)

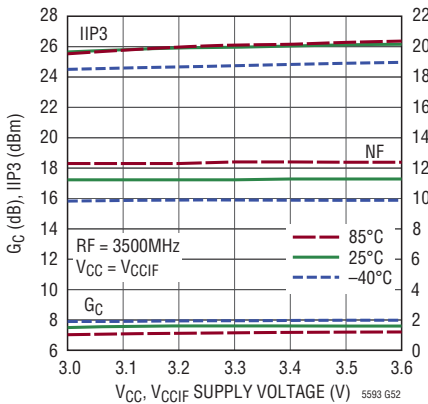

Conversion Gain, IIP3 and RF Input P1dB vs Temperature

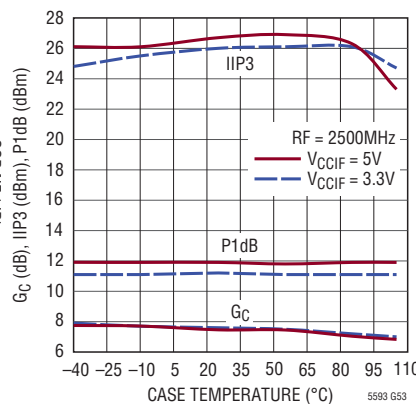

RF Isolation and LO Leakage vs Frequency

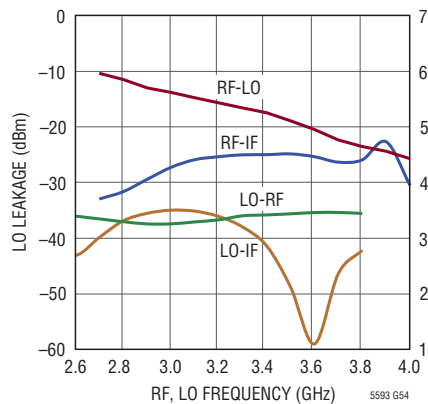

TYPICAL AC PERFORMANCE CHARACTERISTICS

2.7GHz to 4GHz, low side LO, $I_{SEL} = \text{high}$ (low power mode). $V_{CC} = 3.3V$, $V_{CCIF} = 3.3V$, $ENA = ENB = \text{high}$, $T_C = 25^\circ\text{C}$, $P_{LO} = 0\text{dBm}$, $P_{RF} = -3\text{dBm}$ ($-3\text{dBm}/\text{tone}$ for 2-tone IIP3 tests, $\Delta f = 2\text{MHz}$), $IF = 190\text{MHz}$, unless otherwise noted. Test circuit shown in Figure 1.

Conversion Gain and IIP3 vs RF Frequency

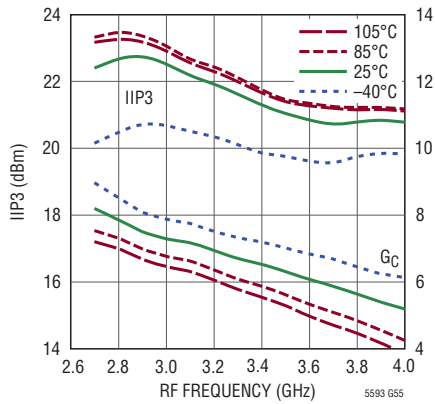

SSB NF vs RF Frequency

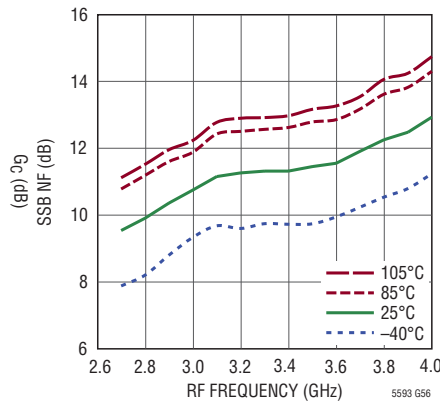

Channel Isolation vs RF Frequency

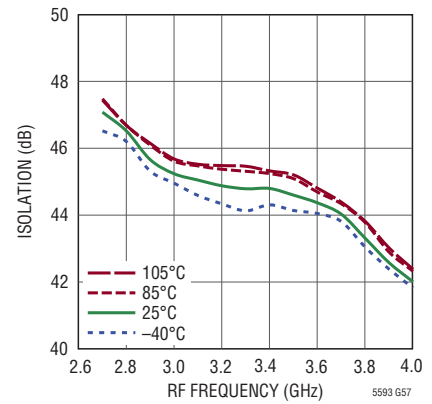

3200MHz Conversion Gain, IIP3 and NF vs LO Power

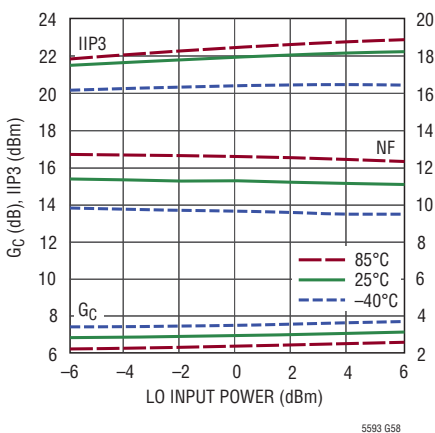

3500MHz Conversion Gain, IIP3 and NF vs LO Power

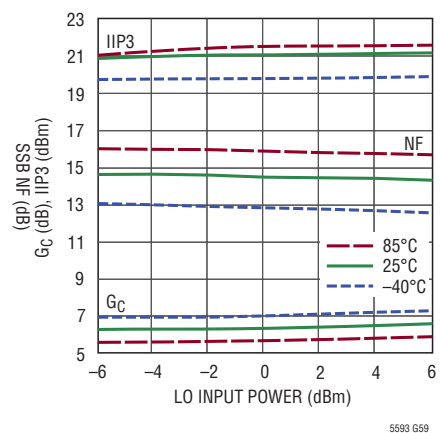

3800MHz Conversion Gain, IIP3 and NF vs LO Power

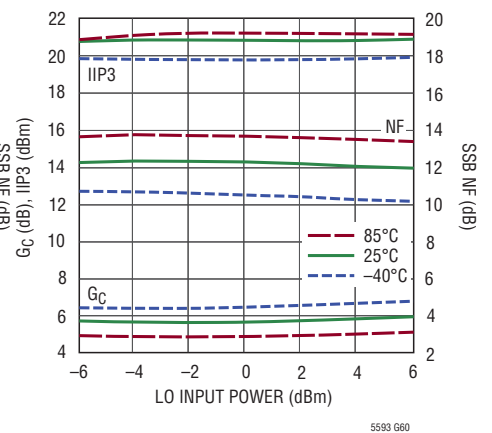

Conversion Gain, IIP3 and NF vs Supply Voltage (Single Supply)

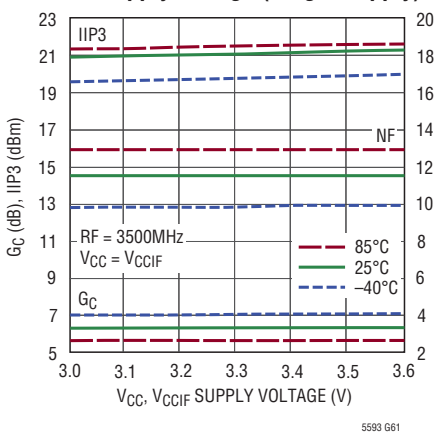

Conversion Gain, IIP3 and RF Input P1dB vs Temperature

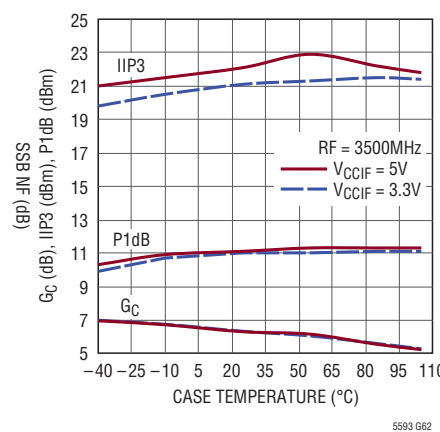

RF Isolation and LO Leakage vs Frequency

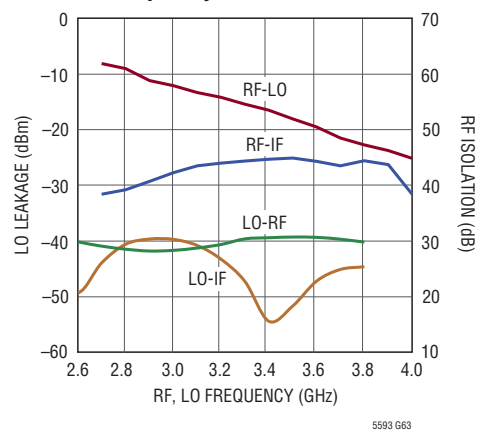

TYPICAL AC PERFORMANCE CHARACTERISTICS

2.7GHz to 4GHz, high side LO. $V_{CC} = 3.3V$, $V_{CCIF} = 3.3V$, ENA = ENB = high, $I_{SEL} = \text{low}$, $T_C = 25^\circ\text{C}$, $P_{LO} = 0\text{dBm}$, $P_{RF} = -3\text{dBm}$ (-3dBm/tone for 2-tone IIP3 tests, $\Delta f = 2\text{MHz}$), $IF = 190\text{MHz}$, unless otherwise noted. Test circuit shown in Figure 1.

Conversion Gain and IIP3 vs RF Frequency

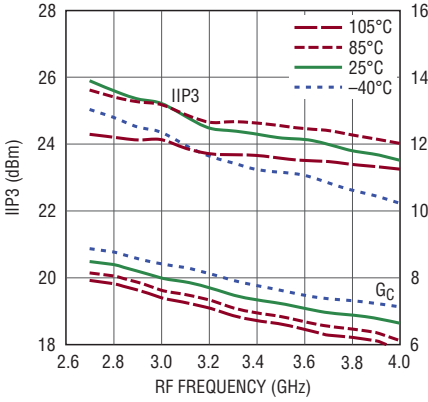

5593 G64

SSB NF vs RF Frequency

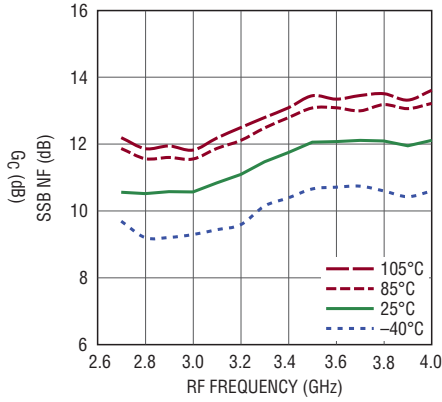

5593 G65

Channel Isolation vs RF Frequency

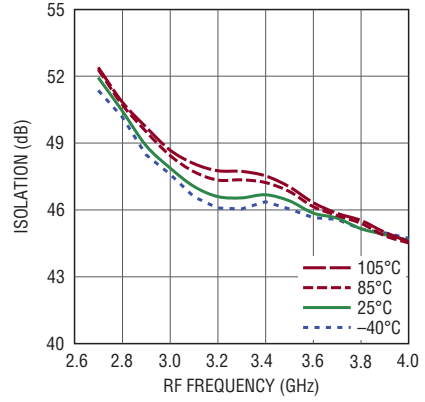

5593 G66

3200MHz Conversion Gain, IIP3 and NF vs LO Power

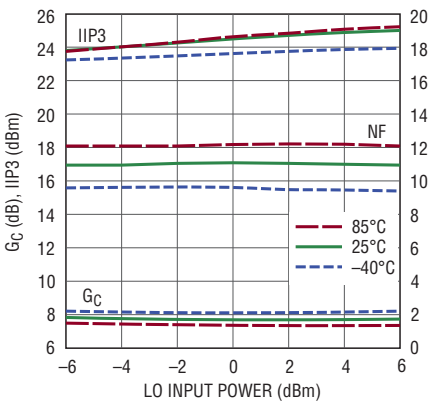

5593 G67

3500MHz Conversion Gain, IIP3 and NF vs LO Power

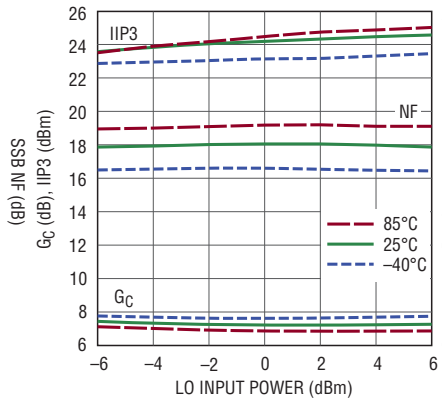

5593 G68

3800MHz Conversion Gain, IIP3 and NF vs LO Power

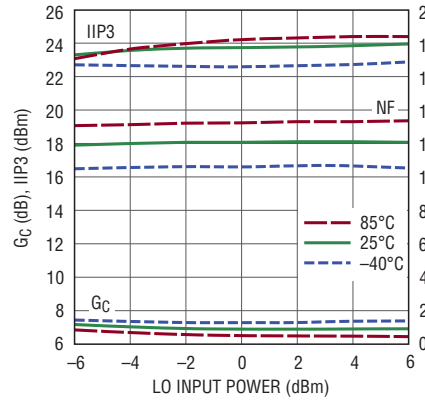

5593 G69

Conversion Gain, IIP3 and NF vs Supply Voltage (Single Supply)

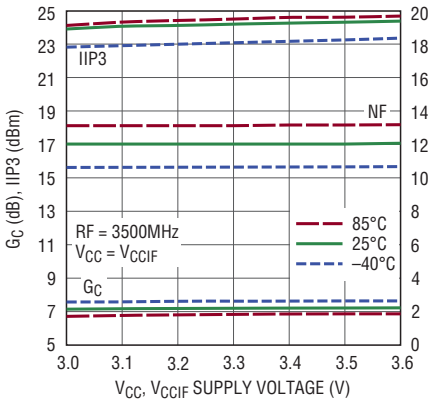

5593 G70

Conversion Gain, IIP3 and RF Input P1dB vs Temperature

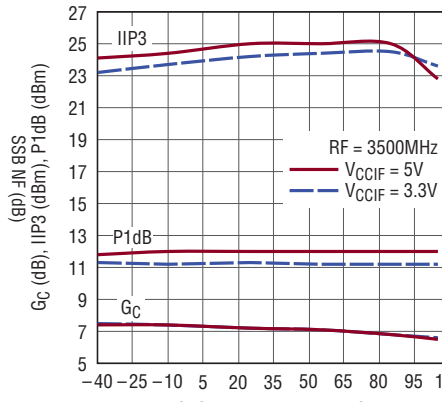

5593 G71

RF Isolation and LO Leakage vs Frequency

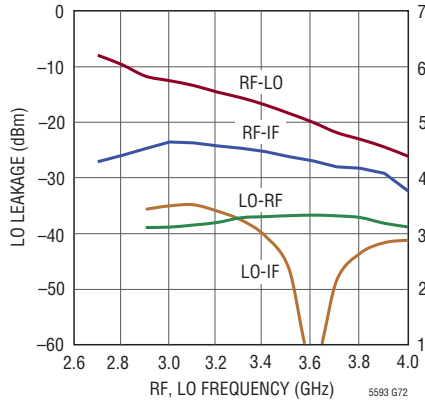

5593 G72

TYPICAL AC PERFORMANCE CHARACTERISTICS

2.7GHz to 4GHz, high side LO, I_{SEL} = high (low power mode). V_{CC} = 3.3V, V_{CCIF} = 3.3V, ENA = ENB = high, T_C = 25°C, P_{LO} = 0dBm, P_{RF} = -3dBm (-3dBm/tone for 2-tone IIP3 tests, Δf = 2MHz), IF = 190MHz, unless otherwise noted. Test circuit shown in Figure 1.

Conversion Gain and IIP3 vs RF Frequency

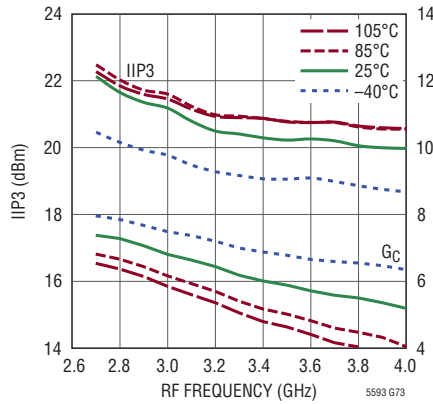

SSB NF vs RF Frequency

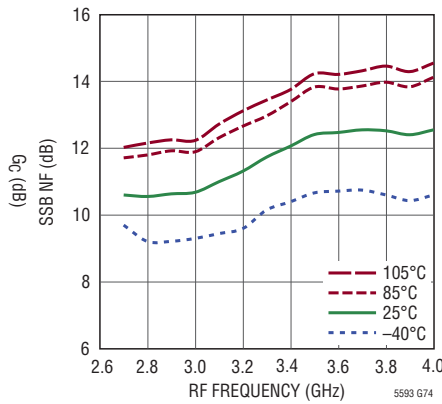

Channel Isolation vs RF Frequency

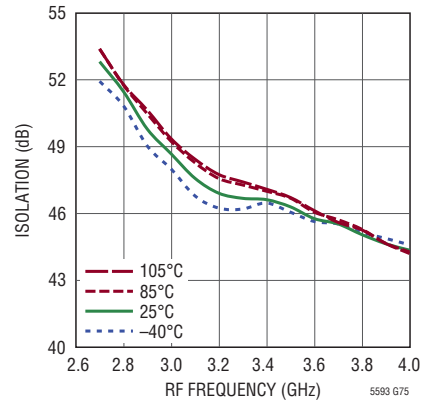

3200MHz Conversion Gain, IIP3 and NF vs LO Power

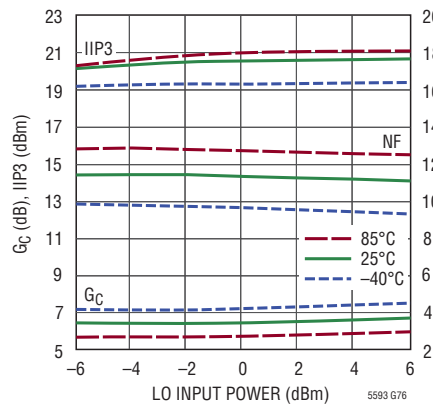

3500MHz Conversion Gain, IIP3 and NF vs LO Power

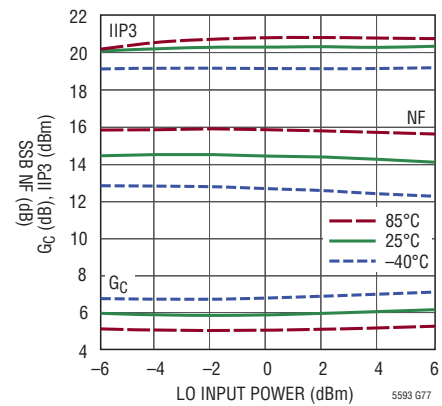

3800MHz Conversion Gain, IIP3 and NF vs LO Power

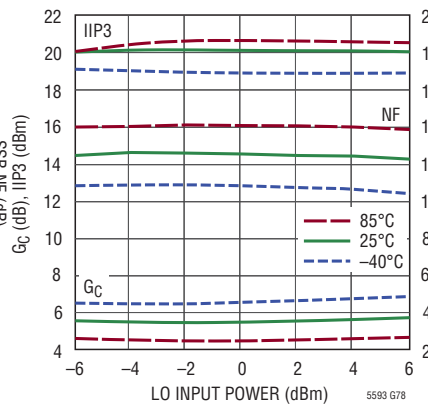

Conversion Gain, IIP3 and NF vs Supply Voltage (Single Supply)

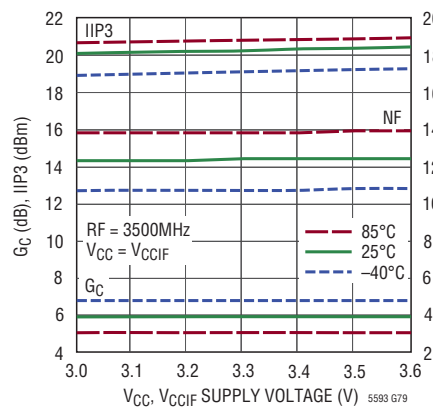

Conversion Gain, IIP3 and RF Input P1dB vs Temperature

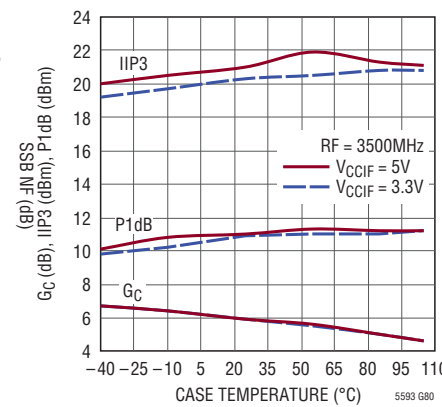

RF Isolation and LO Leakage vs Frequency

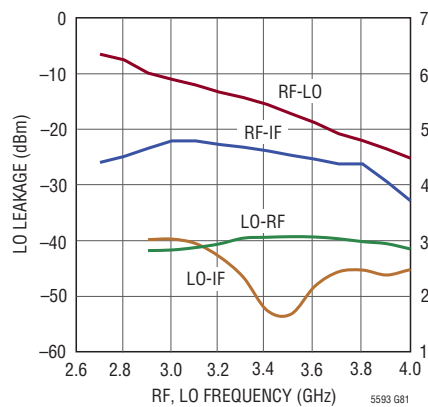

TYPICAL DC PERFORMANCE CHARACTERISTICS

I_{SEL} = low, $EN_A = EN_B$ = high, test circuit shown in Figure 1

V_{CC} Supply Current vs Supply Voltage (Mixer and LO Amplifier)

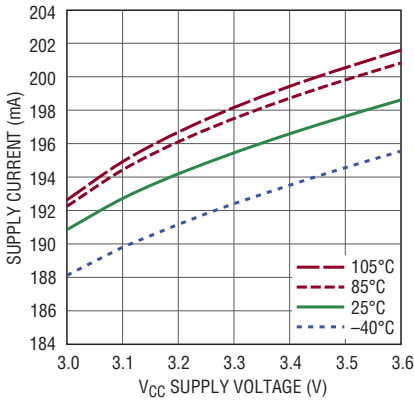

5593 G82

V_{CCIF} Supply Current vs Supply Voltage (IF Amplifier)

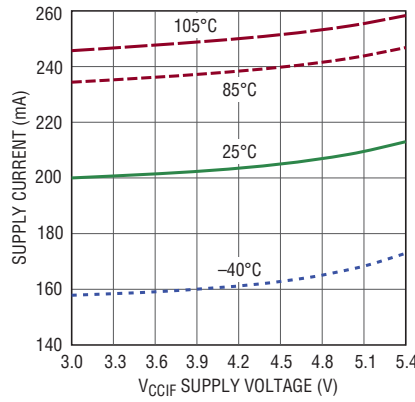

5593 G83

Total Supply Current vs Temperature ($V_{CC} + V_{CCIF}$)

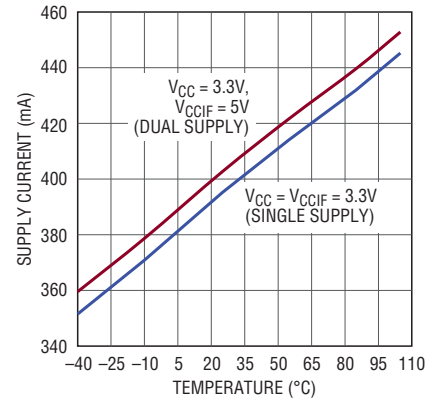

5593 G84

I_{SEL} = high (low power mode), $EN_A = EN_B$ = high, test circuit shown in Figure 1

V_{CC} Supply Current vs Supply Voltage (Mixer and LO Amplifier)

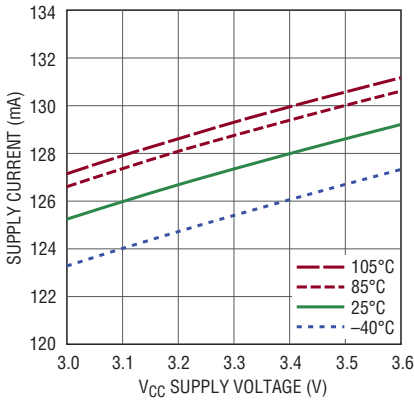

5593 G85

V_{CCIF} Supply Current vs Supply Voltage (IF Amplifier)

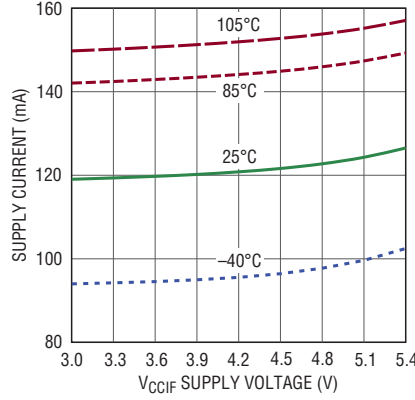

5593 G86

Total Supply Current vs Temperature ($V_{CC} + V_{CCIF}$)

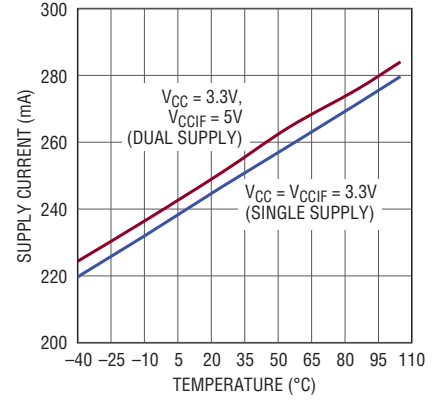

5593 G87

PIN FUNCTIONS

RFA, RFB (Pins 1, 6): Single-Ended RF Inputs for Channels A and B. These pins are internally connected to the primary sides of the RF input transformers, which have low DC resistance to ground. **Series DC-blocking capacitors should be used to avoid damage to the integrated transformer when DC voltage is present at the RF inputs.**

The RF inputs are impedance matched when the LO input is driven with a 0 ± 6 dBm source between 2.1GHz and 4.2GHz and the channels are enabled.

CTA, CTB (Pins 2, 5): RF Transformer Secondary Center-Tap on Channels A and B. These pins may require bypass capacitors to ground to optimize IIP3 performance. Each pin has an internally generated bias voltage of 1.2V and must be DC-isolated from ground and V_{CC} .

GND (Pins 3, 4, 7, 13, 15, 24, Exposed Pad Pin 25): Ground. These pins must be soldered to the RF ground plane on the circuit board. The exposed pad metal of the package provides both electrical contact to ground and good thermal contact to the printed circuit board.

IFGNDB, IFGNDA (Pins 8, 23): DC Ground Returns for the IF Amplifiers. These pins must be connected to ground to complete the DC current paths for the IF amplifiers. Chip inductors may be used to tune LO-IF and RF-IF leakage. Typical DC current is 100mA for each pin.

IFB⁺, IFB⁻, IFA⁻, IFA⁺ (Pins 9, 10, 21, 22): Open-Collector Differential Outputs for the IF Amplifiers of Channels B and A. These pins must be connected to a DC supply through impedance matching inductors, or transformer center-taps. Typical DC current consumption is 50mA into each pin.

IFBB, IFBA (Pins 11, 20): Bias Adjust Pins for the IF Amplifiers. These pins allow independent adjustment of the internal IF buffer currents for channels B and A, respectively. The typical DC voltage on these pins is 2.2V. If not used, these pins must be DC isolated from ground and V_{CC} .

V_{CCB} and V_{CCA} (Pins 12, 19): Power Supply Pins for the LO Buffers and Bias Circuits. These pins must be connected to a regulated 3.3V supply with bypass capacitors located close to the pins. Typical current consumption is 98mA per pin.

ENB, ENA (Pins 14, 17): Enable Pins. These pins allow Channels B and A, respectively, to be independently enabled. An applied voltage of greater than 2.5V activates the associated channel while a voltage of less than 0.3V disables the channel. Typical input current is less than 10 μ A. These pins must not be allowed to float.

LO (Pin 16): Single-Ended Local Oscillator Input. This pin is internally connected to the primary side of the LO input transformer and has a low DC resistance to ground. **Series DC-blocking capacitors should be used to avoid damage to the integrated transformer when DC voltage is present at the LO input.** The LO input is internally matched to 50 Ω for all states of ENA and ENB.

I_{SEL} (Pin 18): Low Power Select Pin. When this pin is pulled low (<0.3V), both mixer channels are biased at the normal current level for best RF performance. When greater than 2.5V is applied, both channels operate at reduced current, which provides reasonable performance at lower power consumption. This pin must not be allowed to float.

BLOCK DIAGRAM

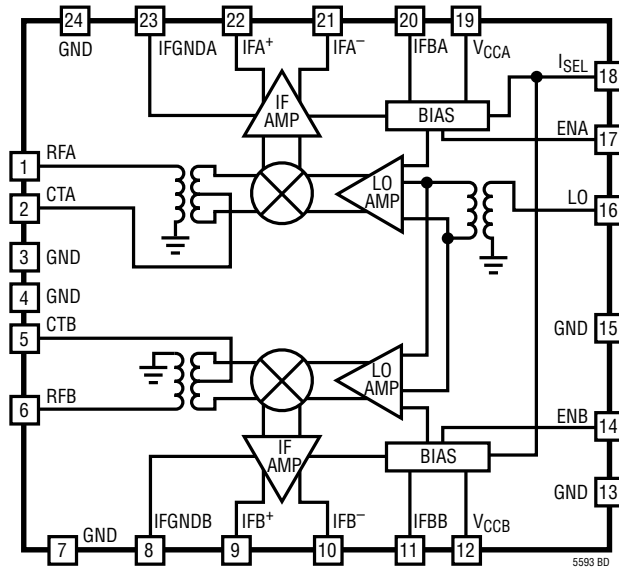

TEST CIRCUIT

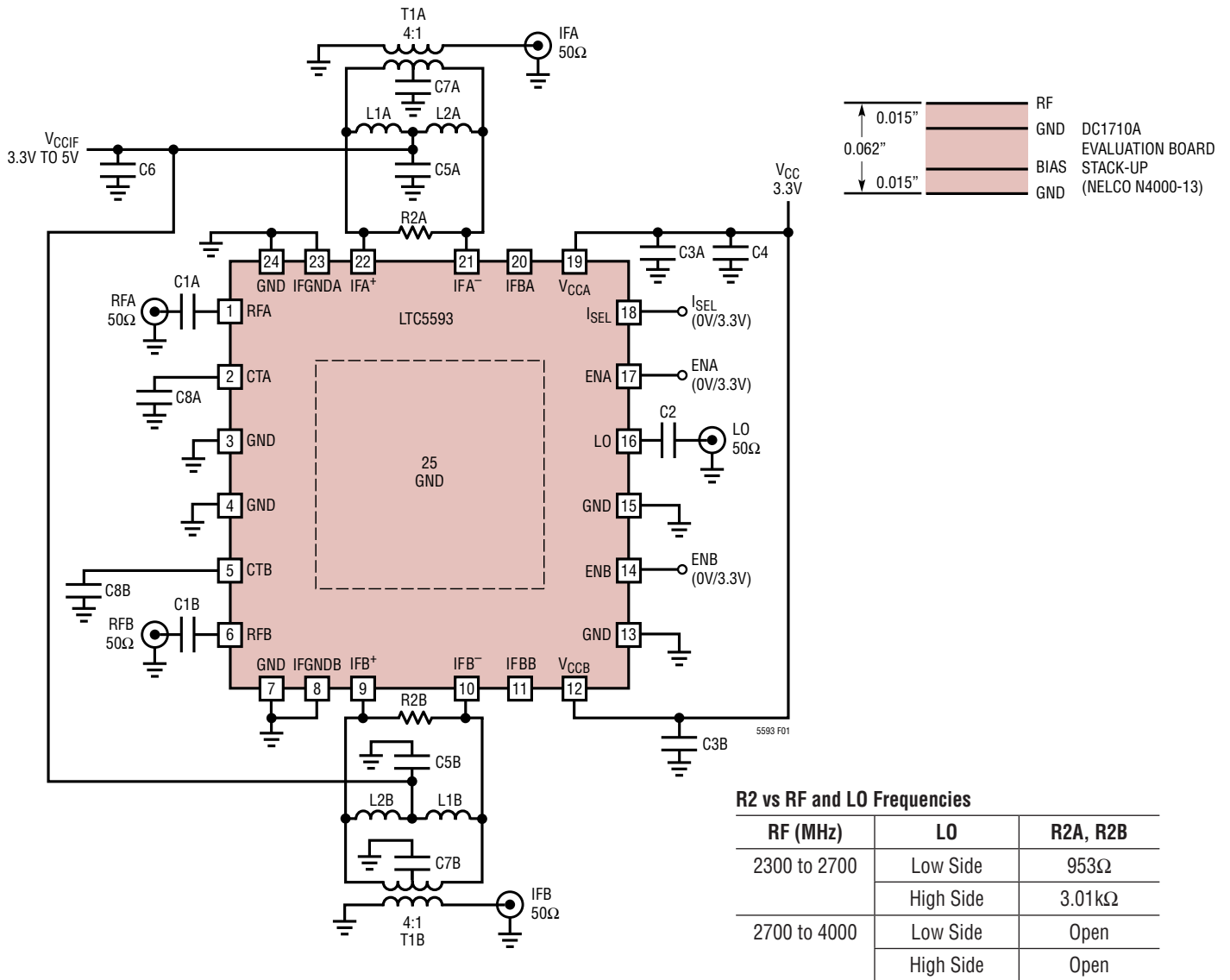

R2 vs RF and LO Frequencies

RF (MHz)	LO	R2A, R2B
2300 to 2700	Low Side	953Ω
	High Side	3.01kΩ
2700 to 4000	Low Side	Open
	High Side	Open

L1, L2 vs IF FREQUENCIES	
IF (MHz)	L1A, L1B, L2A, L2B (nH)
140	270
190	150
240	100
300	56
380	33
470	22

REF DES	VALUE	SIZE	VENDOR
C1A, C1B, C3A, C3B, C5A, C5B	22pF	0402	AVX
C2	1.5pF	0402	AVX
C8A, C8B	10pF	0402	AVX
C4, C6	1μF	0603	AVX
C7A, C7B	1000pF	0402	AVX
L1A, L1B, L2A, L2B	150nH	0603	Coilcraft
T1A, T1B (Alternate)	TC4-1W-7ALN+ (WBC4-6TLB)		Mini-Circuits (Coilcraft)

Figure 1. Standard Test Circuit Schematic (190MHz IF)

APPLICATIONS INFORMATION

Introduction

The LTC5593 consists of two identical mixer channels driven by a common LO input signal. Each high linearity mixer consists of a passive double-balanced mixer core, IF buffer amplifier, LO buffer amplifier and bias/enable circuits. See the Pin Functions and Block Diagram sections for a description of each pin. Each of the mixers can be shutdown independently to reduce power consumption and low current mode can be selected that allows a trade-off between performance and power consumption. The RF and LO inputs are single-ended and are internally matched to 50Ω. low side or high side LO injection can be used. The IF outputs are differential. The evaluation circuit, shown in Figure 1, utilizes bandpass IF output matching and an IF transformer to realize a 50Ω single-ended IF output. The evaluation board layout is shown in Figure 2.

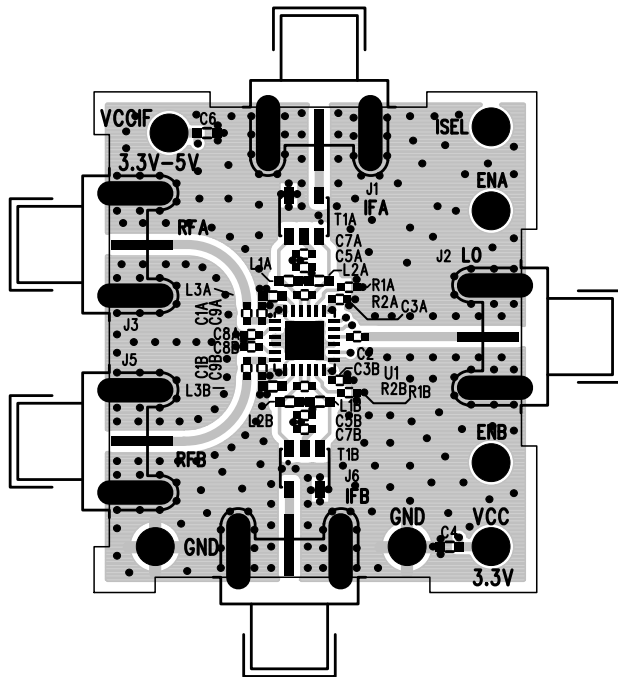

Figure 2. Evaluation Board Layout

RF Inputs

The RF inputs of channels A and B are identical. The RF input of channel A, shown in Figure 3, is connected to the primary winding of an integrated transformer. A 50Ω match is realized when a series external capacitor, C1A, is connected to the RF input. C1A is also needed for DC blocking if the source has DC voltage present, since the primary side of the RF transformer is internally DC-grounded. The DC resistance of the primary is approximately 3.6Ω.

The secondary winding of the RF transformer is internally connected to the channel A passive mixer core. The center-tap of the transformer secondary is connected to Pin 2 (CTA) to allow the connection of bypass capacitor, C8A. The value of C8A can be adjusted to improve the

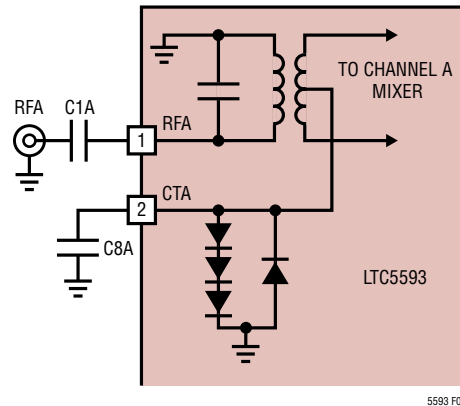
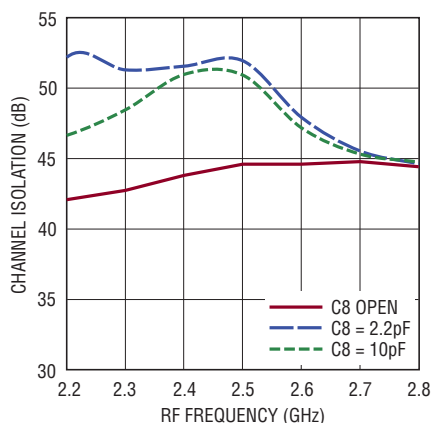

Figure 3. Channel A RF Input Schematic

APPLICATIONS INFORMATION

channel-to-channel isolation at specific RF operation frequency with minor impact to conversion gain, linearity and noise performance. The channel-to-channel isolation performance with different values of C8A is given in Figure 4. When used, it should be located within 2mm of Pin 2 for proper high frequency decoupling. The nominal DC voltage on the CTA pin is 1.2V.



5593 F04

Figure 4. Channel-to-Channel Isolation vs C8 Values

For the RF inputs to be properly matched, the appropriate LO signal must be applied to the LO input. A broadband input match is realized with C1A = 22pF. The measured input return loss is shown in Figure 5 for LO frequencies of 2.4GHz, 3.0GHz and 3.6GHz. These LO frequencies correspond to lower, middle and upper values in the LO range. As shown in Figure 5, the RF input impedance is dependent on LO frequency, although a single value of C1A is adequate to cover the 2.3GHz to 4.0GHz RF band.

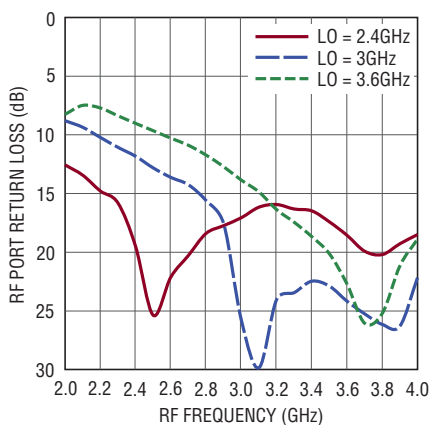

5593 F05

Figure 5. RF Port Return Loss

The RF input impedance and input reflection coefficient, versus RF frequency, are listed in Table 1. The reference plane for this data is Pin 1 of the IC, with no external matching, and the LO is driven at 2.31GHz.

Table 1. RF Input Impedance and S11 (at Pin1, No External Matching, LO Input Driven at 2.31GHz)

FREQUENCY (GHZ)	RF INPUT IMPEDANCE	S11	
		MAG	ANGLE
2.0	74.2 + j13.6	0.22	23.1
2.2	69.4 - j6.4	0.17	-15.2
2.4	45.2 - j3.0	0.06	-146.0
2.6	45.6 + j6.5	0.08	120.3
2.8	48.3 + j10.9	0.11	92.3
3.0	51.5 + j14.1	0.14	75.9
3.2	57.1 + j15.5	0.16	57.3
3.4	62.6 + j11.8	0.15	37.2
3.6	64.3 + j4.7	0.13	16.0
3.8	63.6 - j6.8	0.13	-23.2
4.0	50.8 - j10.7	0.11	-79.4

LO Input

The LO input, shown in Figure 6, is connected to the primary winding of an integrated transformer. A 50Ω impedance match from 2.1GHz to 3.4GHz is realized at the LO port by adding a 1.5pF external series capacitor, C2. This capacitor is also needed for DC blocking if the LO source has DC voltage present, since the primary side of the LO transformer is DC-grounded internally. The DC resistance of the primary is approximately 1.8Ω. For LO frequency

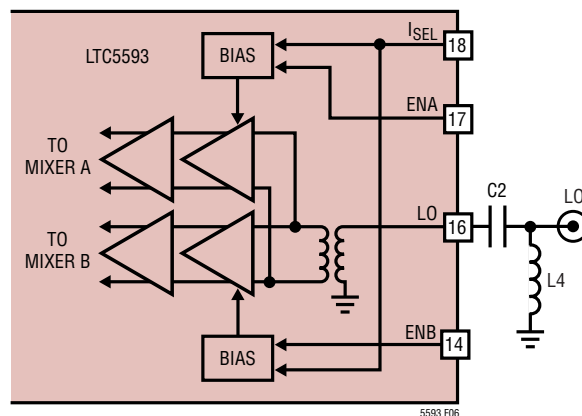

5593 F06

Figure 6. LO Input Schematic

5593f

APPLICATIONS INFORMATION

from 3.4GHz to 3.8GHz, the LO port can be well matched by using $C2 = 0.6\text{pF}$ and $L4 = 10\text{nH}$.

The secondary of the transformer drives a pair of high speed limiting differential amplifiers for channels A and B. The LTC5593's LO amplifiers are optimized for the 2.1GHz to 4.2GHz LO frequency range; however, LO frequencies outside this frequency range may be used with degraded performance.

The LO port is always 50Ω matched, even when one or both of the channels is disabled. This helps to reduce frequency pulling of the LO source when the mixer is switched between different operating states. Figure 7 illustrates the LO port return loss for the different operating modes.

The nominal LO input level is 0dBm , though the limiting amplifiers will deliver excellent performance over a $\pm 6\text{dBm}$ input power range. Table 2 lists the LO input impedance and input reflection coefficient versus frequency.

Table 2. LO Input Impedance vs Frequency
(at Pin 16, No External Matching, ENA = ENB = High)

FREQUENCY (GHz)	INPUT IMPEDANCE	S11	
		MAG	ANGLE
2.0	$33.8 + j22.8$	0.32	110.3
2.2	$34.8 + j22.2$	0.31	109.7
2.4	$34.5 + j21.8$	0.31	110.9
2.6	$32.5 + j22.8$	0.34	111.9
2.8	$30.7 + j25.9$	0.38	108.8
3.0	$29.6 + j30.1$	0.43	103.4
3.2	$29.3 + j34.8$	0.47	97.1
3.4	$29.3 + j38.7$	0.50	92.1
3.6	$30.7 + j43.1$	0.52	86.0
3.8	$33.0 + j46.9$	0.52	80.5
4.0	$36.1 + j49.8$	0.52	75.6

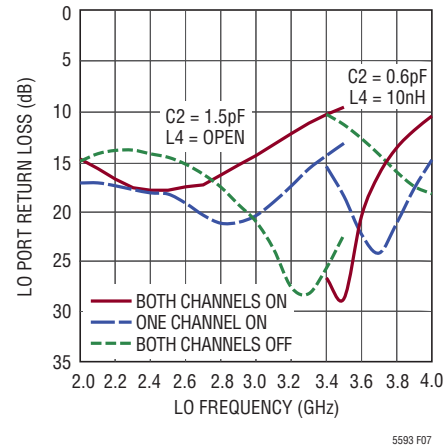

Figure 7. LO Input Return Loss

IF Outputs

The IF amplifiers in channels A and B are identical. The IF amplifier for channel A, shown in Figure 8, has differential open collector outputs (IFA⁺ and IFA⁻), a DC ground return pin (IFGNDA), and a pin for adjusting the internal bias (IFBA). The IF outputs must be biased at the supply voltage (V_{CCIFA}), which is applied through matching inductors L1A and L2A. Alternatively, the IF outputs can be biased through the center tap of a transformer (T1A). The common node of L1A and L2A can be connected to the center tap of the transformer. Each IF output pin draws approximately 50mA of DC supply current (100mA total). An external load resistor, R2A, can be used to improve impedance matching if desired.

IFGNDA (Pin 23) must be grounded or the amplifier will not draw DC current. Inductor L3A may improve LO-IF and RF-IF leakage performance in some applications, but is otherwise not necessary. Inductors should have small resistance for DC. High DC resistance in L3A will reduce the IF amplifier supply current, which will degrade RF performance.

APPLICATIONS INFORMATION

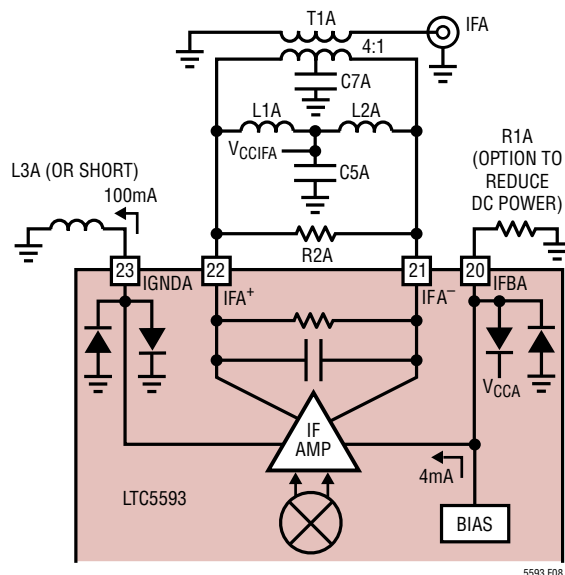

Figure 8. IF Amplifier Schematic with Bandpass Match

For optimum single-ended performance, the differential IF output must be combined through an external IF transformer or a discrete IF balun circuit. The evaluation board (see Figures 1 and 2) uses a 4:1 IF transformer for impedance transformation and differential to single-ended conversion. It is also possible to eliminate the IF transformer and drive differential filters or amplifiers directly.

The IF output impedance can be modeled as 260Ω in parallel with 2.3pF . The equivalent small-signal model, including bondwire inductance, is shown in Figure 9. Frequency-dependent differential IF output impedance is listed in Table 3. This data is referenced to the package pins (with no external components) and includes the effects of IC and package parasitics.

Bandpass IF Matching

The bandpass IF matching configuration, shown in Figures 1 and 8, is best suited for IF frequencies in the 90MHz to 600MHz range. Resistor R2A may be used to

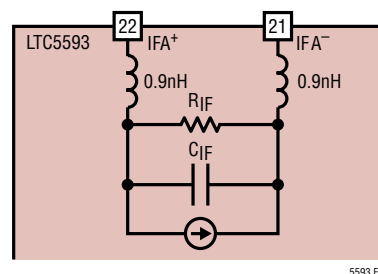

Figure 9. IF Output Small-Signal Model

reduce the IF output resistance for greater bandwidth and inductors L1A and L2A resonate with the internal IF output capacitance at the desired IF frequency. The value of L1A, L2A can be estimated as follows:

$$L1A = L2A = \frac{1}{[(2\pi f_{IF})^2 \cdot 2 \cdot C_{IF}]}$$

where C_{IF} is the internal IF capacitance (listed in Table 3).

APPLICATIONS INFORMATION

Table 3. IF Output Impedance vs Frequency

FREQUENCY (MHz)	DIFFERENTIAL OUTPUT IMPEDANCE ($R_{IF} \parallel X_{IF} (C_{IF})$)
90	291 \parallel -j714 (2.5pF)
140	282 \parallel -j463 (2.5pF)
190	274 \parallel -j353 (2.4pF)
240	265 \parallel -j278 (2.4pF)
300	252 \parallel -j225 (2.4pF)
380	231 \parallel -j177 (2.4pF)
500	227 \parallel -j127 (2.5pF)

Values of L1A and L2A are tabulated in Figure 1 for various IF frequencies. The measured IF output return loss for bandpass IF matching is plotted in Figure 10.

Performances of 470MHz IF output frequency with low side LO injection using bandpass IF matching is shown in Figure 11. The test circuit schematic and components values are shown in Figure 1 with R2 open in this example. The test conditions are: $V_{CC} = 3.3V$, $V_{CCIF} = 3.3V$, ENA = ENB = high, $I_{SEL} = \text{low}$, $T_C = 25^\circ C$.

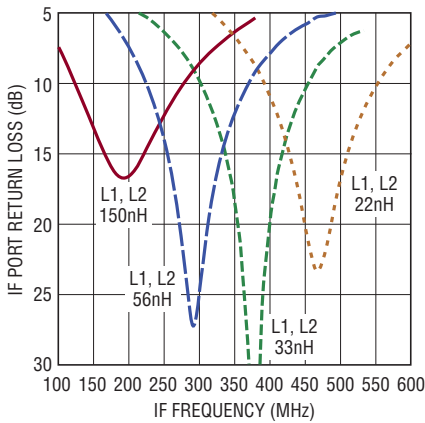

Figure 10. IF Output Return Loss with Bandpass Matching

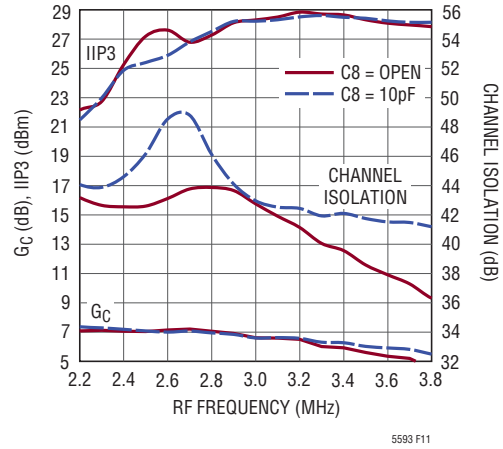

Figure 11. Performances of 470MHz IF Using Bandpass Matching

Lowpass IF Matching

For IF frequencies below 90MHz, the inductance values become unreasonably high and the lowpass topology shown in Figure 12 is preferred. This topology also can provide improved RF to IF and LO to IF isolation. V_{CCIFA} is supplied through the center tap of the 4:1 transformer. A lowpass impedance transformation is realized by shunt

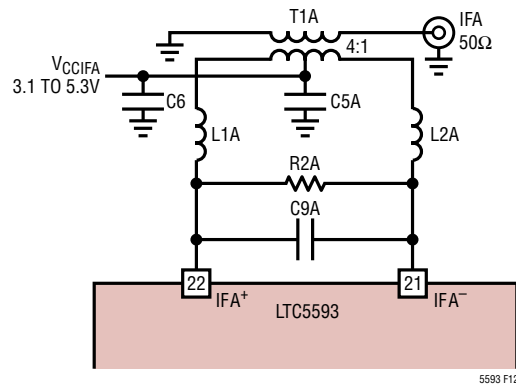

Figure 12. IF Output with Lowpass Matching

APPLICATIONS INFORMATION

elements R2A and C9A (in parallel with the internal R1F and C1F), and series inductors L1A and L2A. Resistor R2A is used to reduce the IF output resistance for greater bandwidth, or it can be deleted for the highest conversion gain. The final impedance transformation to 50Ω is realized by transformer T1A. The measured IF output return loss for lowpass IF matching with R2A and C9A open is plotted in Figure 13. The LTC5593 demo board (see Figure 2) has been laid out to accommodate this matching topology with only minor modifications.

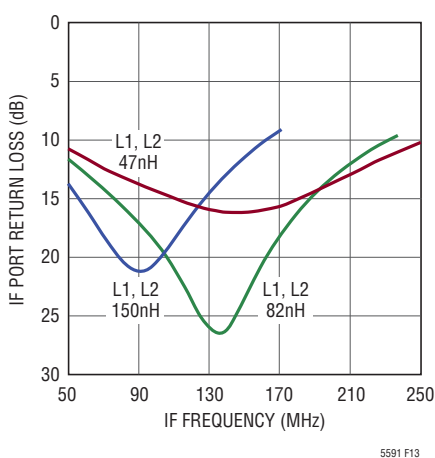

Figure 13. IF Output Return Loss with Lowpass Matching

IF Amplifier Bias

The IF amplifier delivers excellent performance with $V_{CCIF} = 3.3V$, which allows a single supply to be used for V_{CC} and V_{CCIF} . At $V_{CCIF} = 3.3V$, the RF input P1dB of the mixer is limited by the output voltage swing. For higher P1dB, in this case, resistor R2A (Figure 1) can be used to reduce the output impedance and thus the voltage swing, thus improving P1dB. The trade-off for improved P1dB will be lower conversion gain.

With V_{CCIF} increased to 5V the P1dB increases by over 3dB, at the expense of higher power consumption. Mixer P1dB performance at 2500MHz is tabulated in Table 4 for

V_{CCIF} values of 3.3V and 5V. For the highest conversion gain, high-Q wire-wound chip inductors are recommended for L1A and L2A, especially when using $V_{CCIF} = 3.3V$. Low cost multilayer chip inductors may be substituted, with a slight reduction in conversion gain.

Table 4. Performance Comparison with $V_{CCIF} = 3.3V$ and 5V (RF = 2500MHz, Low Side LO, IF = 190MHz, ENA = ENB = High)

V_{CCIF} (V)	R2A (Ω)	I_{CCIF} (mA)	G_C (dB)	P1dB (dBm)	IIP3 (dBm)	NF (dB)
3.3	953	200	8.5	10.4	27.7	9.5
	Open	200	9.6	9.6	27.2	9.5
5	953	207	8.4	13.7	28.5	9.7
	Open	207	9.5	13.3	27.4	9.7

The IFBA pin (Pin 20) is available for reducing the DC current consumption of the IF amplifier, at the expense of IIP3. The nominal DC voltage at Pin 20 is 2.1V, and this pin should be left open-circuited for optimum performance. The internal bias circuit produces a 4mA reference for the IF amplifier, which causes the amplifier to draw approximately 100mA. If resistor R1A is connected to Pin 20 as shown in Figure 8, a portion of the reference current can be shunted to ground, resulting in reduced IF amplifier current. For example, $R1A = 470\Omega$ will shunt away 1.4mA from Pin 20 and the IF amplifier current will be reduced by 35% to approximately 65mA. Table 5 summarizes RF performance versus total IF amplifier current when both channels are enabled.

Table 5. Mixer Performance with Reduced IF Amplifier Current (RF = 2500MHz, Low Side LO, IF = 190MHz, $V_{CC} = V_{CCIF} = 3.3V$)

R1A, R1B	I_{CCIF} (mA)	G_C (dB)	IIP3 (dBm)	P1dB (dBm)	NF (dB)
Open	200	8.5	27.7	10.4	9.5
3.3k Ω	176	8.4	26.7	10.5	9.5
1.0k Ω	151	8.1	24.9	10.5	9.4
470 Ω	130	8.0	23.5	10.4	9.3

APPLICATIONS INFORMATION

Low Power Mode

Both mixer channels can be set to low power mode using the I_{SEL} pin. This allows flexibility to choose a reduced current mode of operation when lower RF performance is acceptable. Figure 14 shows a simplified schematic of the I_{SEL} pin interface. When I_{SEL} is set low (<0.3V), both channels operate at nominal DC current. When I_{SEL} is set high (>2.5V), the DC currents in both channels are reduced, thus reducing power consumption. The performance in low power mode and normal power mode are compared in Table 6.

Table 6. Performance Comparison Between Different Power Mode
RF = 2500MHz, Low Side LO, IF = 190MHz, ENA = ENB = High

I _{SEL}	I _{TOTAL} (mA)	G _C (dB)	IIP3 (dBm)	P1dB (dBm)	NF (dB)
Low	396	8.5	27.7	10.4	9.5
High	247	7.8	21.6	10.0	9.2

Enable Interface

Figure 15 shows a simplified schematic of the ENA pin interface (ENB is identical). To enable channel A, the ENA voltage must be greater than 2.5V. If the enable function is not required, the enable pin can be connected directly to V_{CC}. The voltage at the enable pin should never exceed the power supply voltage (V_{CC}) by more than 0.3V. If this should occur, the supply current could be sourced through the ESD diode, potentially damaging the IC.

The Enable pins must be pulled high or low. If left floating, the on/off state of the IC will be indeterminate. If a three-state condition can exist at the enable pins, then a pull-up or pull-down resistor must be used.

Supply Voltage Ramping

Fast ramping of the supply voltage can cause a current glitch in the internal ESD protection circuits. Depending on the supply inductance, this could result in a supply voltage transient that exceeds the maximum rating. A supply voltage ramp time of greater than 1ms is recommended.

Spurious Output Levels

Mixer spurious output levels versus harmonics of the RF and LO are tabulated in Table 7. The spur levels were measured on a standard evaluation board using the test circuit shown in Figure 1. The spur frequencies can be calculated using the following equation:

$$f_{SPUR} = (M \cdot f_{RF}) - (N \cdot f_{LO})$$

Table 7. IF Output Spur Levels (dBc)

RF = 2500MHz, F_{RF} = -3dBm, F_{LO} = 0dBm, F_{IF} 190MHz, Low Side LO, V_{CC} = 3.3V, V_{CCIF} = 3.3V, ENA = ENB = High, I_{SEL} = Low, T_C = 25°C

		N								
		0	1	2	3	4	5	6	7	8
M	0		-40	-48	-60	-51	-83	-62	-74	*
	1	-48	-0	-75	-62	-69	-69	*	*	*
	2	-74	-78	-61	-85	-82	-87	-89	*	*
	3	*	*	*	-65	*	*	*	*	*
	4	*	*	*	*	*	*	*	*	*
	5		*	*	*	*	*	*	*	*
	6			*	*	*	*	*	*	*

*Less than -90dBc

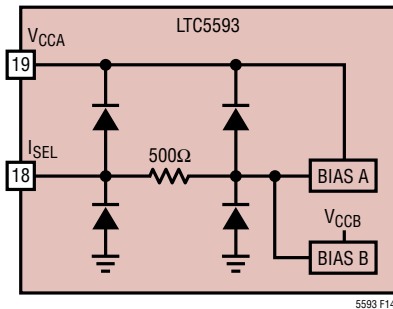

Figure 14. I_{SEL} Interface Schematic

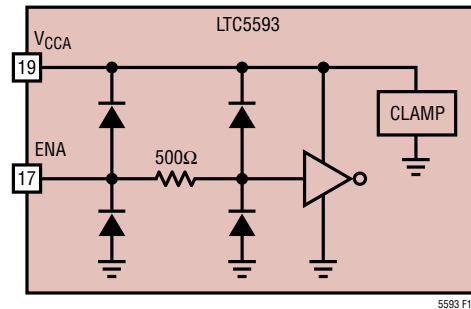
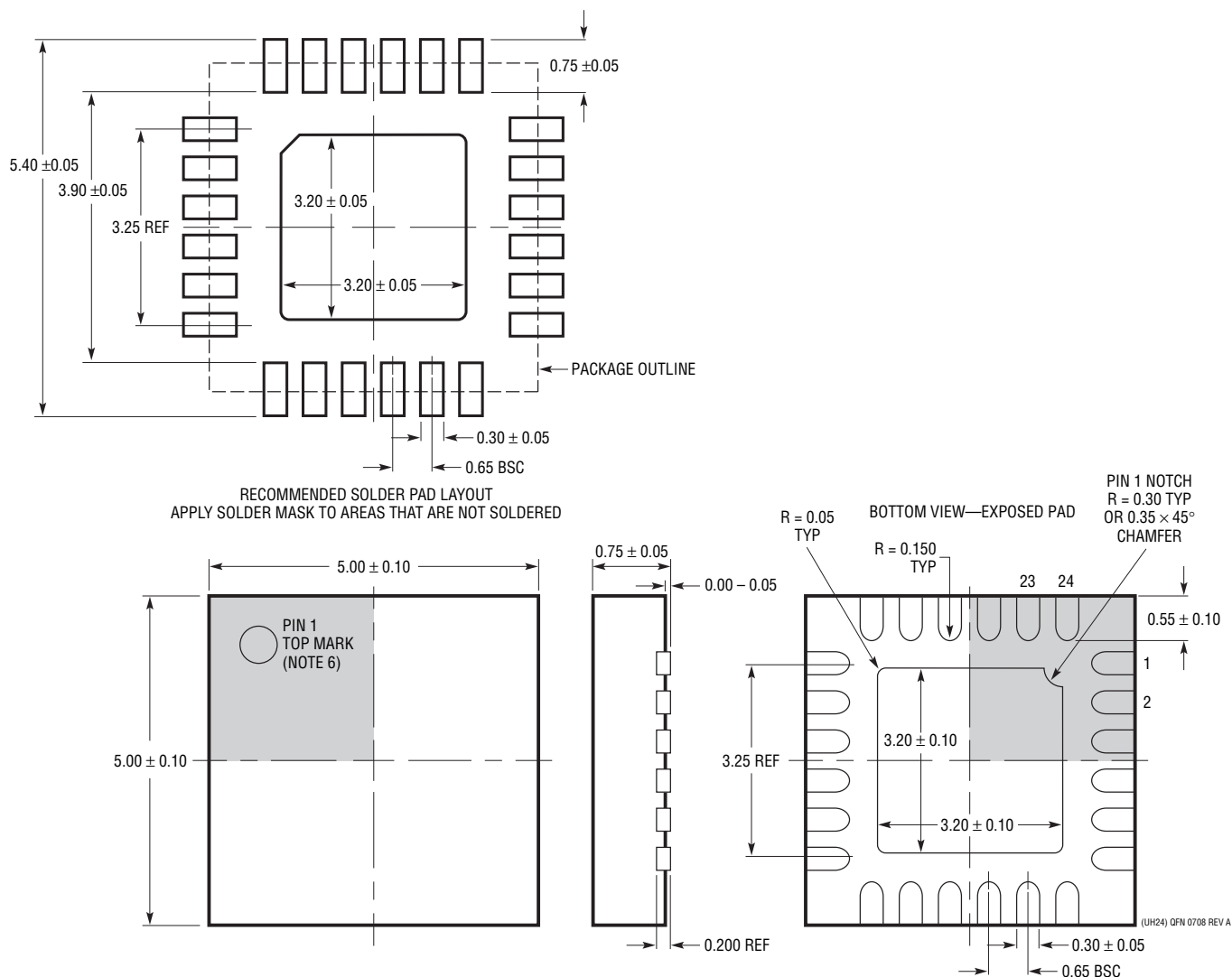

Figure 15. ENA Interface Schematic

PACKAGE DESCRIPTION

Please refer to <http://www.linear.com/designtools/packaging/> for the most recent package drawings.

UH Package
24-Lead Plastic QFN (5mm × 5mm)
 (Reference LTC DWG # 05-08-1747 Rev A)



TYPICAL APPLICATION

Extended frequency range 3.7GHz to 4.5GHz, low side LO, $V_{CC} = 3.3V$, $V_{CCIF} = 3.3V$, $ENA = \text{high}$, $ENB = I_{SEL} = \text{low}$, $T_C = 25^\circ C$, $P_{LO} = 0\text{dBm}$, $P_{RF} = -3\text{dBm}$ ($-3\text{dBm}/\text{tone}$ for 2-tone IIP3 Tests, $\Delta f = 2\text{MHz}$), $IF = 305\text{MHz}$

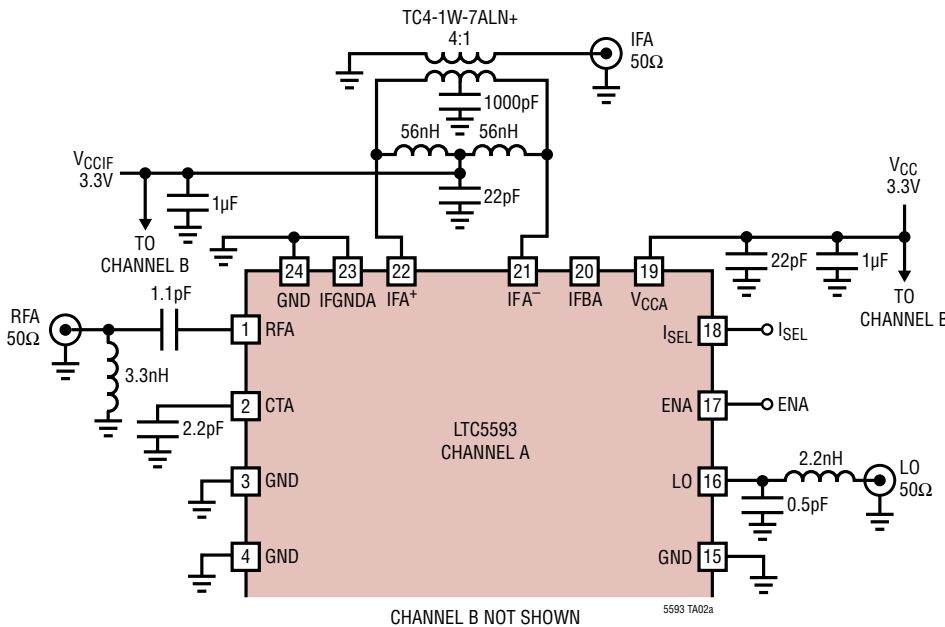

Conversion Gain, IIP3 and SSB NF vs RF Frequency

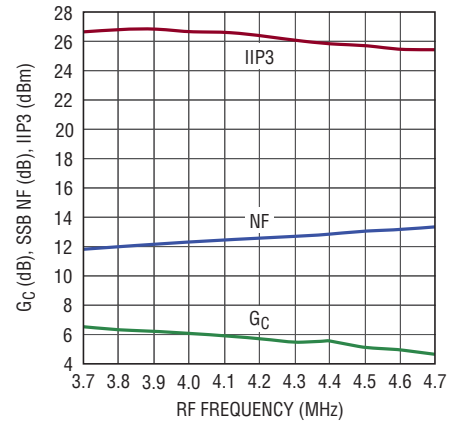

RELATED PARTS

PART NUMBER	DESCRIPTION	COMMENTS
Infrastructure		
LTC5569	300MHz to 4GHz Dual Active Downconverting Mixer	2dB Gain, 26.7dBm IIP3 and 11.7dB NF at 1950MHz, 3.3V/180mA Supply
LT5527	400MHz to 3.7GHz, 5V Downconverting Mixer	2.3dB Gain, 23.5dBm IIP3 and 12.5dB NF at 1900MHz, 5V/78mA Supply
LT5557	400MHz to 3.8GHz, 3.3V Downconverting Mixer	2.9dB Gain, 24.7dBm IIP3 and 11.7dB NF at 1950MHz, 3.3V/82mA Supply
LTC6416	2GHz 16-Bit ADC Buffer	40dBm OIP3 to 300MHz, Programmable Fast Recovery Output Clamping
LTC6412	31dB Linear Analog VGA	35dBm OIP3 at 240MHz, Continuous Gain Range -14dB to 17dB
LTC554X	600MHz to 4GHz Downconverting Mixer Family	8dB Gain, >25dBm IIP3, 10dB NF, 3.3V/200mA Supply
LT5554	Ultralow Distort IF Digital VGA	48dBm OIP3 at 200MHz, 2dB to 18dB Gain Range, 0.125dB Gain Steps
LT5578	400MHz to 2.7GHz Upconverting Mixer	27dBm OIP3 at 900MHz, 24.2dBm at 1.95GHz, Integrated RF Transformer
LT5579	1.5GHz to 3.8GHz Upconverting Mixer	27.3dBm OIP3 at 2.14GHz, NF = 9.9dB, 3.3V Supply, Single-Ended LO and RF Ports
LTC5590	Dual 600MHz to 1.7GHz Downconverting Mixer	8.7dB Gain, 26dBm IIP3, 9.7dB Noise Figure
LTC5591	Dual 1.3GHz to 2.3GHz Downconverting Mixer	8.5dB Gain, 26.2dBm IIP3, 9.9dB Noise Figure
LTC5592	Dual 1.6GHz to 2.7GHz Downconverting Mixer	8.3dB Gain, 27.3dBm IIP3, 9.8dB Noise Figure
RF Power Detectors		
LT5534	50MHz to 3GHz Log Detector	±1dB over Temperature, 38ns Response Time, 60dB Dynamic Range
LT5581	6GHz Low Power RMS Detector	40dB Dynamic Range, ±1dB Accuracy Over Temperature, 1.5mA Supply Current
LTC5583	Dual 6GHz RMS Detector	Up to 60dB Dynamic Range, >50dB Isolation, Difference Output for VSWR Measurement
ADCs		
LTC2285	14-Bit, 125MSPS Dual ADC	72.4dB SNR, >88dB SFDR, 790mW Power Consumption
LTC2185	16-Bit, 125MSPS Dual ADC Ultralow Power	76.8dB SNR, 185mW/Channel Power Consumption
LTC2242-12	12-Bit, 250MSPS ADC	65.4dB SNR, 78dB SFDR, 740mW Power Consumption