

## SDT Series



### Features

- RoHS compliant
- High inductance shielded power inductors
- Functions equally well in filter and smoothing circuit applications

### Product Identification

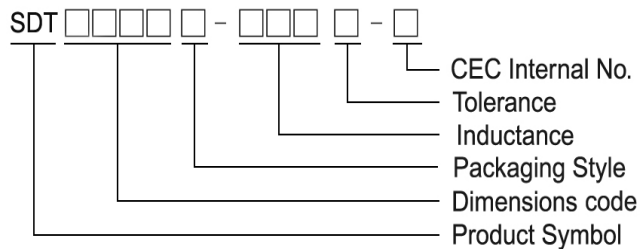

SDT Series is the ultimate cost effective and miniature power inductors. They are constructed of materials specially developed for surface mount applications to ensure the best possible reliability and ease of using and handling. Because of their “swinging” inductance vs. current characteristics, the SSL0402 Series supports used as ultra high inductance at zero or low current.

### Applications

- Board mounted DC-DC converters
- Miniature power supplies and voltage multiplying circuits

### Shape and Dimensions

#### SDT 0402

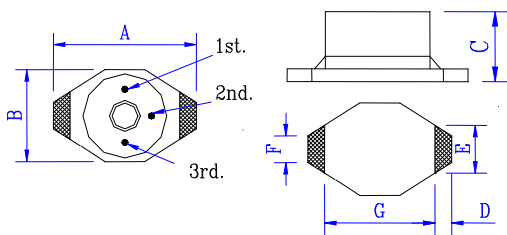

Dimensions in mm

A	B	C	D	E	F	G
6.60 <sup>+0</sup>	4.54 <sup>+0</sup>	2.92 <sup>+0</sup>	1.02	3.05	1.27	4.32

#### SDT 0804

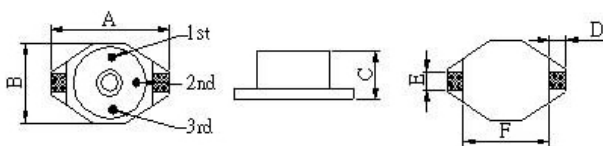

Dimensions in mm

A	B	C	D	E	F
12.95 <sup>+0</sup>	9.4 <sup>+0</sup>	5.08 <sup>+0</sup>	2.54	2.54	7.62

### Recommended Pattern

- Packaging: T : Tape and Reel

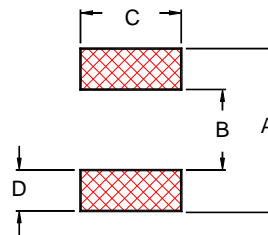

Dimensions in mm

A	B	C	D
6.86	4.06	3.56	1.40

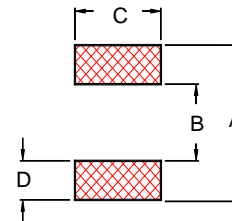

Dimensions in mm

A	B	C	D
13.21	7.37	2.79	2.92

Electrical Characteristics

Specifications				Operating Parameters				
Part Number	Inductance (μH)	Tolerance (±%)	DC Resistance (Ω) Max	Self Resonant Frequency (MHz) Typ.	Inductance Rating (μH)	Current Rating (A)	Energy Storage (μ Joules) Max	Switching Frequency Max
SDT0402T-1R0M-N	1.0	20	0.045	157	0.60	2.0	1.8	1 MHz
SDT0402T-1R5M-N	1.5	20	0.050	108	0.80	1.9	1.8	1 MHz
SDT0402T-2R2M-N	2.2	20	0.060	92	0.90	1.5	1.8	1 MHz
SDT0402T-3R3M-N	3.3	20	0.070	69	1.5	1.2	1.4	1 MHz
SDT0402T-4R7M-N	4.7	20	0.080	59	2.0	1.2	1.6	1 MHz
SDT0402T-6R8M-N	6.8	20	0.085	51	3.0	1.0	1.9	1 MHz
SDT0402T-100M-N	10	20	0.095	33	5.0	0.7	1.2	1 MHz
SDT0402T-150M-N	15	20	0.135	26	6.0	0.6	1.1	1 MHz
SDT0402T-220M-N	22	20	0.160	20	10	0.5	1.2	1 MHz
SDT0402T-330M-N	33	20	0.275	17	12	0.45	1.5	1 MHz
SDT0402T-470M-N	47	20	0.340	12	20	0.34	1.3	1 MHz
SDT0402T-680M-N	68	20	0.575	11	30	0.29	1.4	1 MHz
SDT0402T-101M-N	100	20	1.100	9.4	40	0.24	1.5	1 MHz
SDT0402T-151M-N	150	20	1.400	6.7	60	0.20	1.4	500 KHz
SDT0402T-221M-N	220	20	2.250	6.1	90	0.17	1.6	500 KHz
SDT0402T-331M-N	330	20	2.900	4.7	100	0.16	1.4	500 KHz
SDT0402T-471M-N	470	20	3.600	3.85	150	0.14	1.5	500 KHz
SDT0402T-681M-N	680	20	4.550	3.1	200	0.12	1.4	500 KHz
SDT0402T-102M-N	1000	20	8.100	2.3	400	0.08	1.4	500 KHz

- Inductance tested at 100 KHz.
- Measured at the rated current. Refer to curves below for more detail.
- Average maximum allowable current. SDT Series inductors are designed for current spikes as high as 2X the current rating
- Tolerance: M = ±20%
- Operating temperature range - 40 °C ~ 125 °C (Including self - temperature rise )

Typical Inductance Energy Storage VS. Current

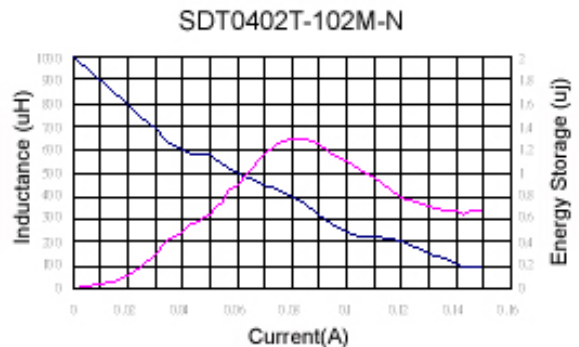
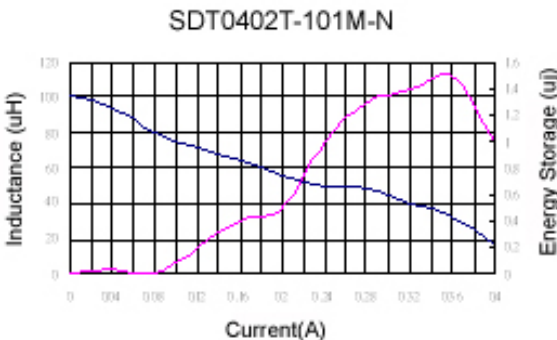
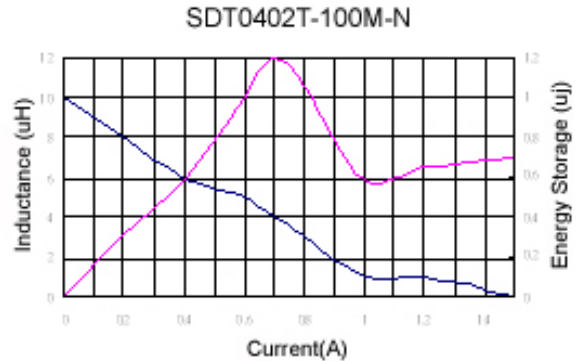
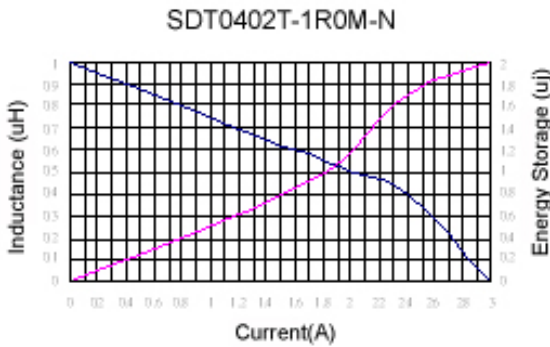

## Electrical Characteristics

Specifications				Operating Parameters				
Part Number	Inductance (μH)	Tolerance (±%)	DC Resistance (Ω) Max	Self Resonant Frequency (MHz) Typ.	Inductance Rating (μH)	Current Rating (A)	Energy Storage (μ Joules) Max	Switching Frequency Max
SDT0804T-1R0M-N	1.0	20	0.025	60	0.50	5.0	9	1 MHz
SDT0804T-1R5M-N	1.5	20	0.030	55	0.70	5.0	12	1 MHz
SDT0804T-2R2M-N	2.2	20	0.035	55	1.00	5.0	15	1 MHz
SDT0804T-3R3M-N	3.3	20	0.040	50	1.50	5.0	16	1 MHz
SDT0804T-4R7M-N	4.7	20	0.045	45	2.00	3.0	10	1 MHz
SDT0804T-6R8M-N	6.8	20	0.050	40	4.00	2.5	14	1 MHz
SDT0804T-100M-N	10	20	0.055	35	5.00	2.0	11	1 MHz
SDT0804T-150M-N	15	20	0.060	25	6.00	1.8	12	1 MHz
SDT0804T-220M-N	22	20	0.084	22	10	1.5	11	1 MHz
SDT0804T-330M-N	33	20	0.090	18	12	1.3	13	1 MHz
SDT0804T-470M-N	47	20	0.11	16	27	1.0	13	1 MHz
SDT0804T-680M-N	68	20	0.15	12	40	0.90	17	1 MHz
SDT0804T-101M-N	100	20	0.29	9	50	0.80	15	1 MHz
SDT0804T-151M-N	150	20	0.36	8	80	0.60	15	500 KHz
SDT0804T-221M-N	220	20	0.39	6	90	0.50	10	500 KHz
SDT0804T-331M-N	330	20	0.73	5	150	0.40	13	500 KHz
SDT0804T-471M-N	470	20	0.88	4	200	0.35	13	500 KHz
SDT0804T-681M-N	680	20	1.15	3	300	0.30	13	500 KHz
SDT0804T-102M-N	1000	20	1.45	2.5	420	0.25	13	500 KHz

- Inductance tested at 100 KHz.
- Measured at the rated current. Refer to curves below for more detail.
- Average maximum allowable current. SDT Series inductors are designed for current spikes as high as 2X the current rating
- Tolerance: M = ±20%
- Operating temperature range – 4 0 °C ~ 1 2 5 °C (Including self - temperature rise )

## Typical Inductance Energy Storage VS. Current

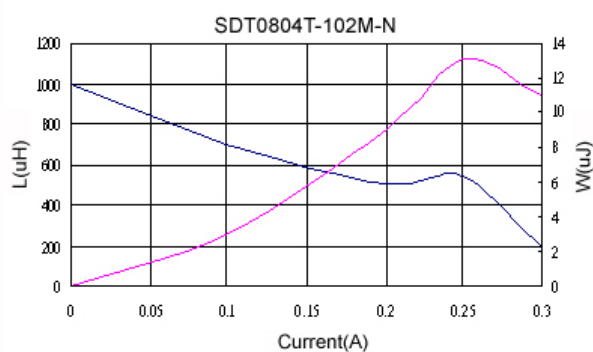
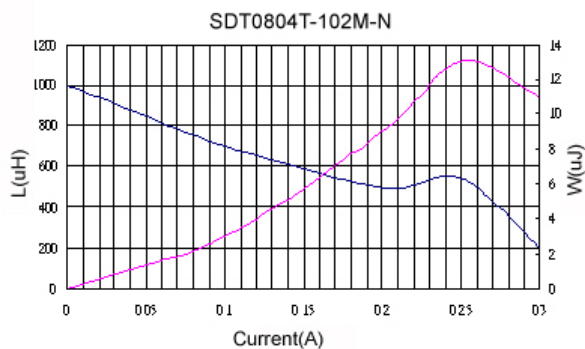
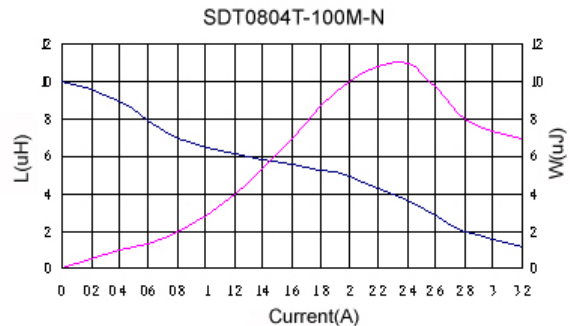
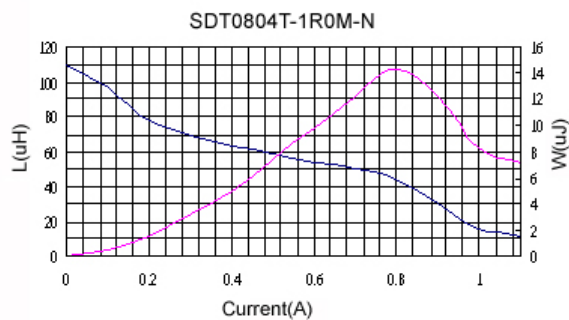

Packaging Specifications

Tape Dimensions

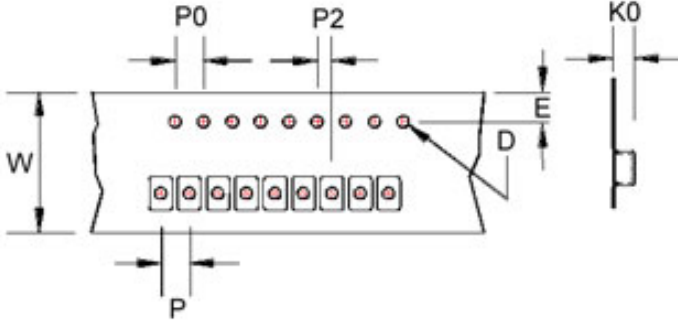

Tape Material

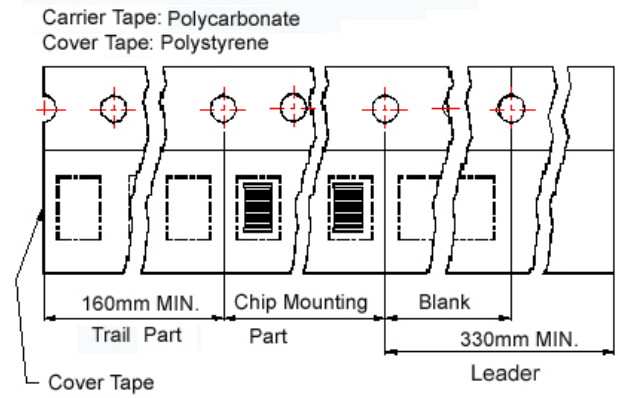

Reel Dimensions

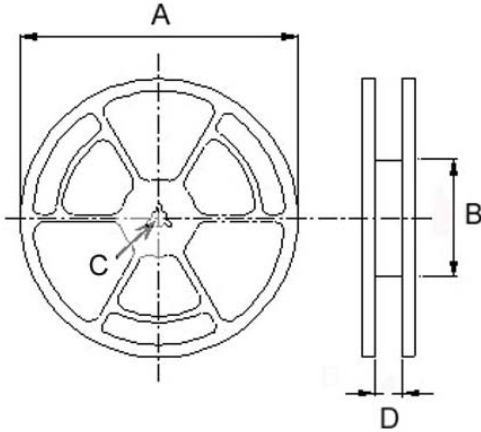

Dimensions in mm

TYPE	Tape Dimensions							Reel Dimensions				Quantity (PCS / REEL)	
	K0	D	E	W	P	P0	P2	A	B	C	D	178mm	330mm
SDT 0402	3.2	1.55	1.75	12	8	4	2	330	100	13	13.4	-	2500
								178	60	13	13.2	750	-
SDT 0804	5.4	1.55	1.75	24	16	4	2	330	100	13	24.4	-	750