

## Features

- $S_{21}$  = 20 dB @ 824 MHz  
= 19 dB @ 894 MHz
- NF of 0.75 dB over Frequency
- Unconditionally Stable
- Single 5V Supply
- High OIP3 @ Low Current

## Description

The plerow™ ALN-series is the compactly designed surface-mount module for the use of the LNA with or without the following gain blocks in the infrastructure equipment of the mobile wireless (CDMA, GSM, PCS, PHS, WCDMA, DMB, WLAN, WiBro, WiMAX), GPS, satellite communication terminals, CATV and so on. It has an exceptional performance of low noise figure, high gain, high OIP3, and low bias current. The stability factor is always kept more than unity over the application band in order to ensure its unconditionally stable implementation to the application system environment. The surface-mount module package including the completed matching circuit and other components necessary just in case allows very simple and convenient implementation onto the system board in mass production level.



1-stage Single Type

## Specifications (in Production)

Typ. @ T = 25°C,  $V_s$  = 5 V, Freq. = 859 MHz,  $Z_{o,sys}$  = 50 ohm

Parameter	Unit	Specifications		
		Min	Typ	Max
Frequency Range	MHz	824		894
Gain	dB	18.5	19.5	
Gain Flatness	dB		± 0.5	± 0.7
Noise Figure	dB		0.75	0.8
Output IP3 <sup>(1)</sup>	dBm	30	31	
S11 / S22 <sup>(2)</sup>	dB			-14 / -14
Output P1dB	dBm	15	16	
Switching Time	μsec		-	
Supply Current	mA		65	75
Supply Voltage	V		5	
Impedance	Ω		50	
Max. RF Input Power	dBm	C.W 29 ~ 31 (before fail)		
Package Type & Size	mm	Surface Mount Type, 10Wx10Lx3.8H		

Operating temperature is -40°C to +85°C.

1) OIP3 is measured with two tones at an output power of 5 dBm / tone separated by 1 MHz.

2) S11/S22 (max) is the worst value within the frequency band.

3) Switching time means the time that takes for output power to get stabilized to its final level after switching DC voltage from 0 V to  $V_s$ .

## More Information

Website: [www.asb.co.kr](http://www.asb.co.kr)  
E-mail: [sales@asb.co.kr](mailto:sales@asb.co.kr)

Tel: (82) 42-528-7223  
Fax: (82) 42-528-7222

ASB Inc., 4th Fl. Venture Town  
Bldg., 367-17 Goijeong-Dong,  
Seo-Gu, Daejeon 302-716, Korea

## Outline Drawing (Unit: mm)

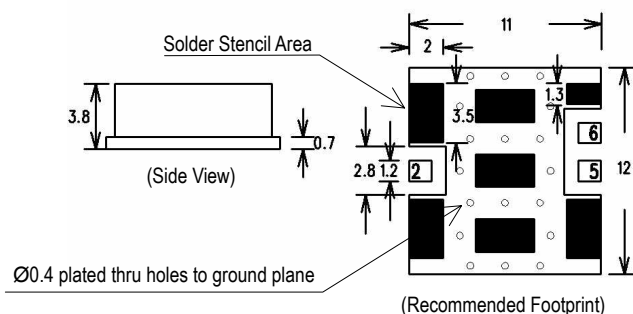
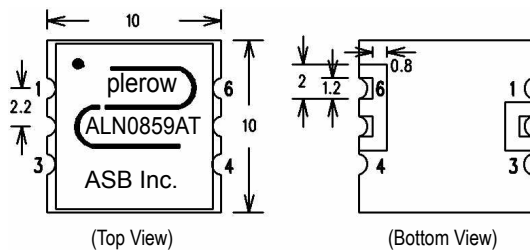

Pin Number	Function
2	RF In
5	RF Out
6	+Vcc
Others	Ground

Note: 1. The number and size of ground via holes in a circuit board is critical for thermal RF grounding considerations.

2. We recommend that the ground via holes be placed on the bottom of all ground pins for better RF and thermal performance, as shown in the drawing at the left side.

**Typical Performance  
(Measured)**

824~894  
+5 V

**S-parameters**

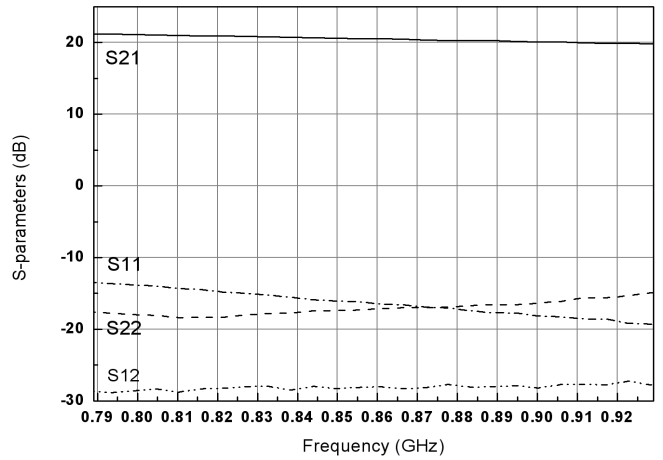

**Stability Factor (K)**

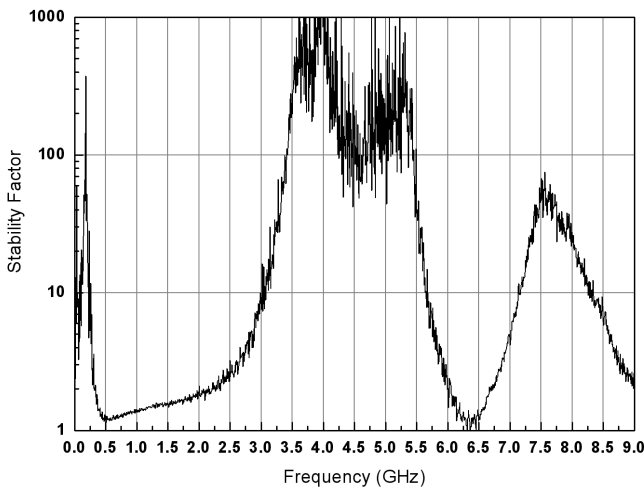

**Noise Figure**

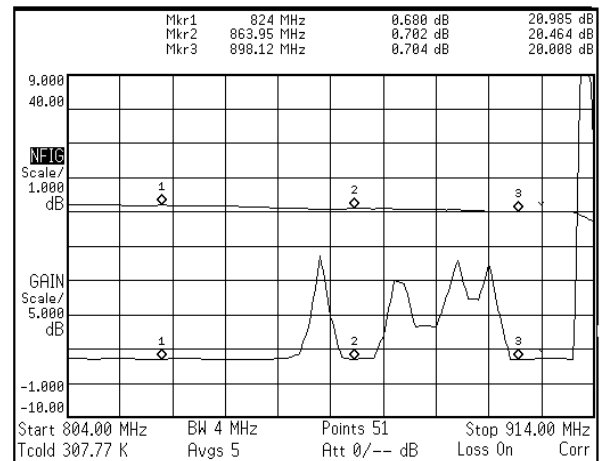

**OIP3**

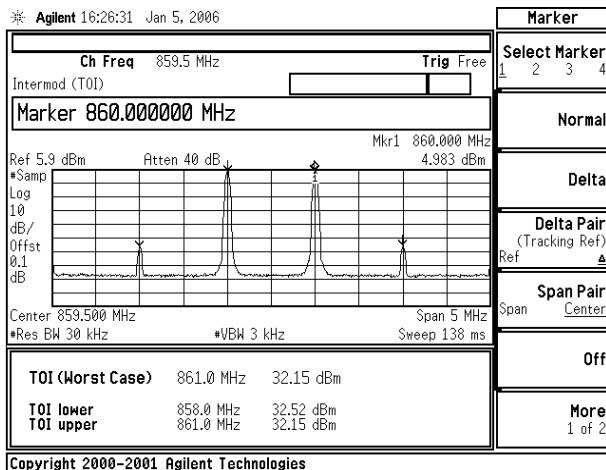

**P1dB**

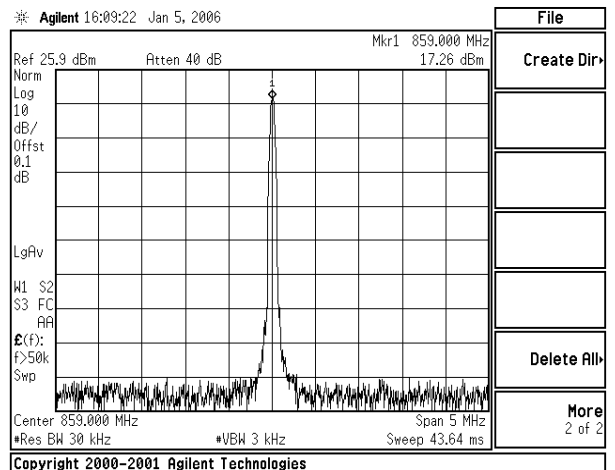

**Gain, P1dB, and OIP3 with Temperature (-40°C ~ 100°C)**

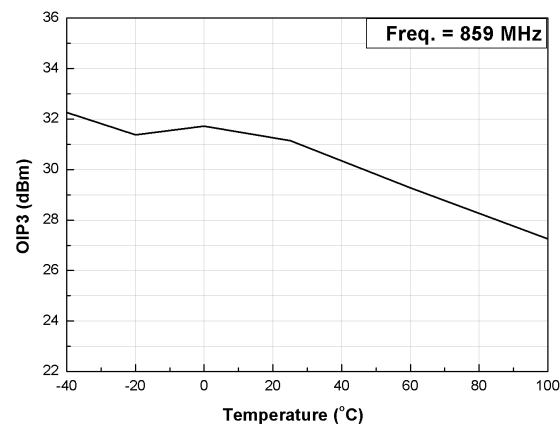
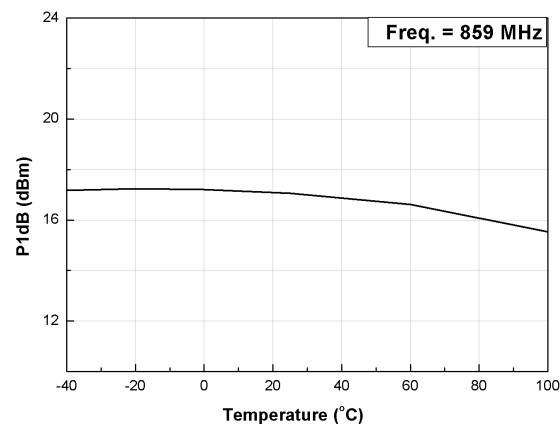
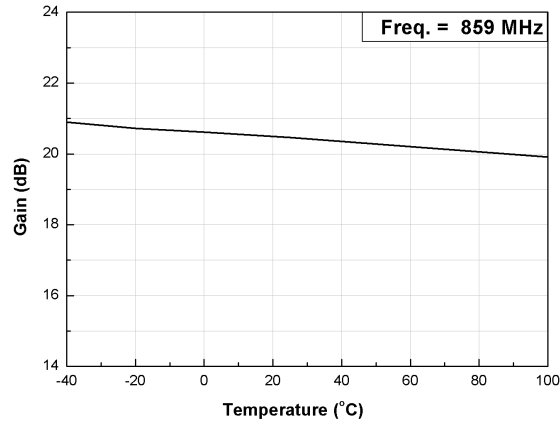

**NF, P1dB, OIP3, and S-parameters with Voltage Change (4.5 V ~ 5.5 V)**

	Voltage (V)	Current (mA)	S21 (dB)			S11 (dB)			S22 (dB)			P1dB (dBm)	OIP3 (dBm)	NF (dB)
			824 MHz	859 MHz	894 MHz	824 MHz	859 MHz	894 MHz	824 MHz	859 MHz	894 MHz			
	4.5	53	20.852	20.469	20.057	-14.685	-16.482	-18.008	-18.189	-17.162	-16.221	16.2	29.19	0.698
	4.6	55	20.894	20.49	20.074	-14.701	-16.684	-17.919	-18.379	-17.036	-16.278	16.4	29.67	0.698
	4.7	57	20.881	20.509	20.103	-14.717	-16.514	-17.944	-18.28	-16.946	-16.294	16.44	29.93	0.7
	4.8	59	20.861	20.46	20.06	-14.75	-16.39	-17.82	-18.34	-16.95	-16.14	16.62	30.39	0.715
	4.9	61	20.863	20.493	20.072	-14.775	-16.522	-17.984	-18.42	-17.141	-16.258	16.78	30.56	0.724
	5	62	20.863	20.493	20.072	-14.775	-16.522	-17.984	-18.42	-17.141	-16.258	16.92	31.32	0.704
	5.1	64	20.852	20.469	20.061	-14.709	-16.445	-17.837	-18.311	-17.027	-16.157	17.06	31.39	0.729
	5.2	66	20.87	20.495	20.108	-14.759	-16.502	-17.918	-18.252	-17.088	-16.213	17.17	31.59	0.74
	5.3	67	20.888	20.52	20.105	-14.77	-16.542	-18.02	-18.334	-17.031	-16.173	17.32	31.75	0.737
	5.4	69	20.89	20.512	20.09	-14.749	-16.476	-17.971	-18.245	-17.124	-16.11	17.47	31.65	0.761
	5.5	70	20.864	20.471	20.067	-14.763	-16.447	-17.977	-18.269	-16.913	-16.29	17.6	31.52	0.753
Variation	1	17	0,012	0,002	0,01	0,078	0,035	0,031	0,08	0,249	0,069	1,4	2,33	0,035

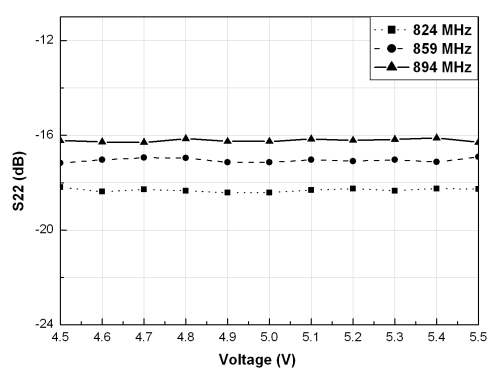
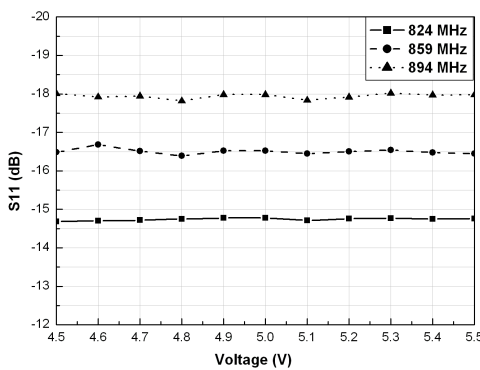
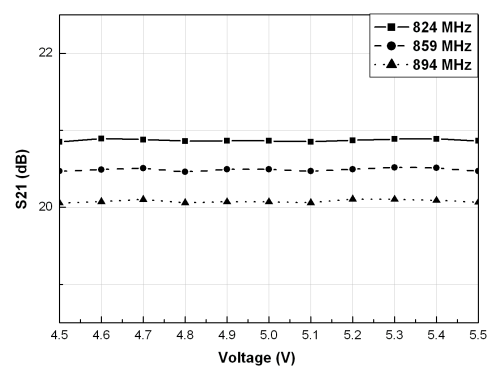
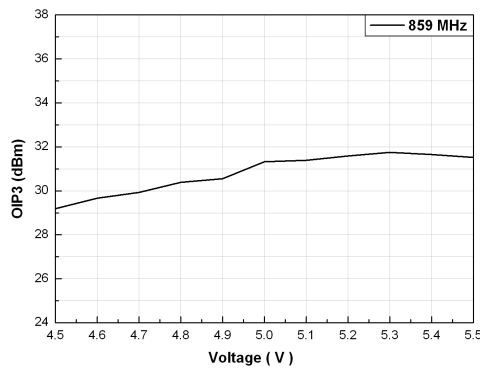
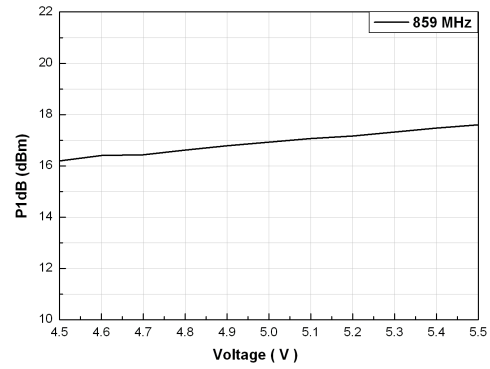
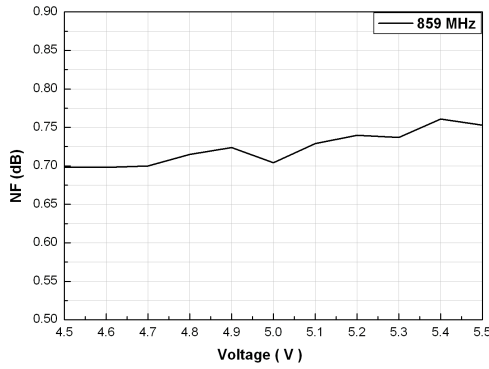

### Application Circuit

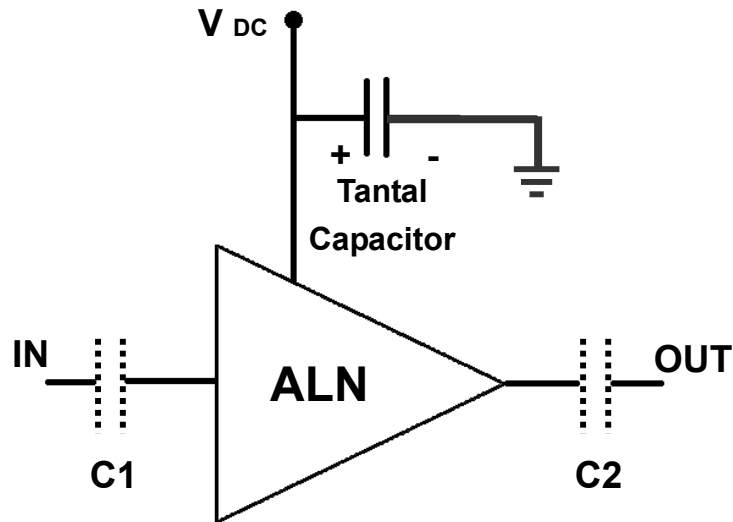

- 1) The tantalum capacitor is optional and for bypassing the AC noise introduced from the DC supply. The capacitance value may be determined by customer's DC supply status.
- 2) So-called DC blocking capacitors are always necessarily placed at the input and output port for allowing only the RF signal to pass and blocking the DC component in the signal. The DC blocking capacitors are included inside the LNA module. Therefore, C1 & C2 capacitors may not be necessary, but can be added just in case that the customer wants. The value of C1 & C2 is determined by considering the application frequency.

### Recommended Soldering Reflow Process

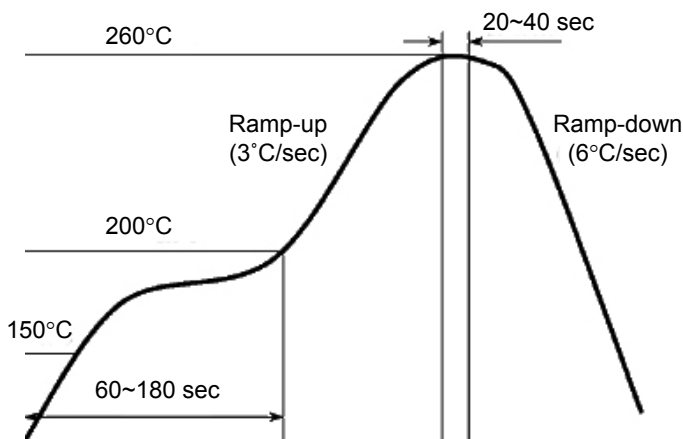

### Evaluation Board Layout

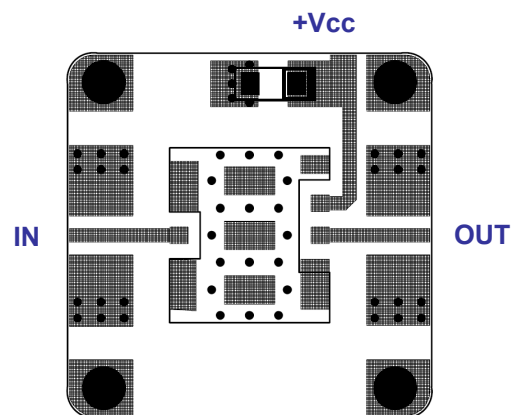

Size 25 x 25mm  
(for ALN-AT, BT, T Series – 10x10mm)