



Micro Commercial Components



Micro Commercial Components
20736 Marilla Street Chatsworth
CA 91311
Phone: (818) 701-4933
Fax: (818) 701-4939

US1AFL THRU US1MFL

1 Amp Ultra Fast Rectifier 50 to 1000 Volts

Features

- Halogen free available upon request by adding suffix "-HF"
- Lead Free Finish/RoHS Compliant(Note 1) ("P" Suffix designates RoHS Compliant. See ordering information)
- Glass Passivated Chip
- Ultra Fast Switching For High Efficiency
- For Surface Mounted Applications
- Low Forward Voltage Drop And High Current Capability
- Low Reverse Leakage Current
- Epoxy meets UL 94 V-0 flammability rating
- Moisture Sensitivity Level 1

Maximum Ratings

- Operating Temperature: -65°C to +175°C
- Storage Temperature: -65°C to +175°C
- Maximum Thermal Resistance; 30°C/W Junction To Lead

MCC Catalog Number	Device Marking	Maximum Recurrent Peak Reverse Voltage	Maximum RMS Voltage	Maximum DC Blocking Voltage
US1AFL	US1A	50V	35V	50V
US1BFL	US1B	100V	70V	100V
US1CFL	US1C	150V	105V	150V
US1DFL	US1D	200V	140V	200V
US1GFL	US1G	400V	280V	400V
US1JFL	US1J	600V	420V	600V
US1KFL	US1K	800V	560V	800V
US1MFL	US1M	1000V	700V	1000V

Electrical Characteristics @ 25°C Unless Otherwise Specified

Average Forward Current	$I_{F(AV)}$	1.0A	$T_L = 110^\circ\text{C}$
Peak Forward Surge Current	I_{FSM}	30A	8.3ms, half sine
Maximum Instantaneous Forward Voltage US1AFL-1DFL US1GFL US1JFL-1MFL	V_F	1.0V 1.4V 1.7V	$I_{FM} = 1.0A$; $T_J = 25^\circ\text{C}$
Maximum DC Reverse Current At Rated DC Blocking Voltage	I_R	10uA 100uA	$T_A = 25^\circ\text{C}$ $T_A = 100^\circ\text{C}$
Maximum Reverse Recovery Time US1AFL-US1GFL US1JFL-US1KFL US1MFL	T_{rr}	50ns 75ns 100ns	$I_F=0.5A, I_R=1.0A,$ $I_{rr}=0.25A$
Typical Junction Capacitance US1AFL-1GFL US1JFL-1MFL	C_J	20pF 17pF	Measured at 1.0MHz, $V_R=4.0V$

*Pulse test: Pulse width 300 sec, Duty cycle 1%

Notes: 1. High Temperature Solder Exemption Applied, see EU Directive Annex Notes 7.

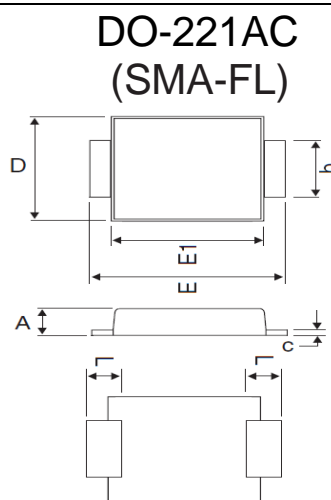

DIMENSIONS

DIM	INCHES		MM		NOTE
	MIN	MAX	MIN	MAX	
A	.035	.043	0.90	1.10	
b	.049	.065	1.25	1.65	
C	.004	.016	0.10	0.40	
D	.089	.116	2.25	2.95	
E	.188	.220	4.80	5.60	
E1	.156	.181	3.95	4.60	
L	.028	.059	0.70	1.50	

SUGGESTED SOLDER PAD LAYOUT

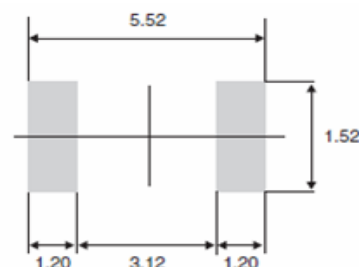

US1AFL thru US1MFL

Figure 1
Typical Forward Characteristics

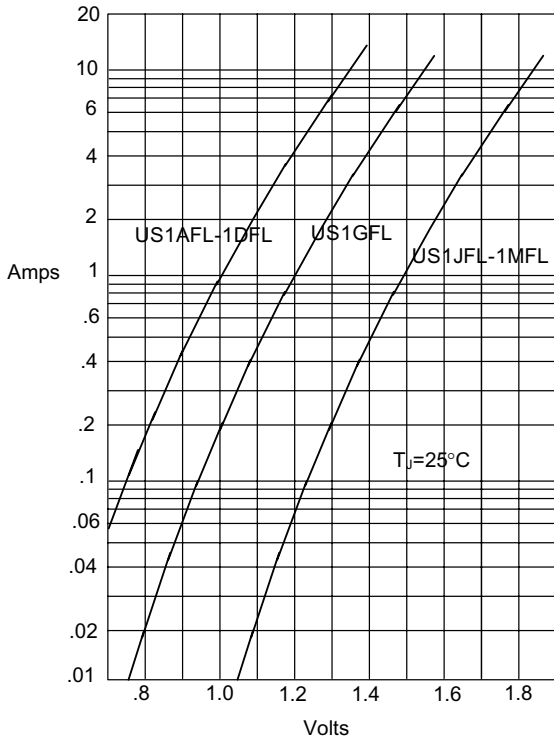

Instantaneous Forward Current - Amperes versus
Instantaneous Forward Voltage - Volts

Figure 2
Forward Derating Curve

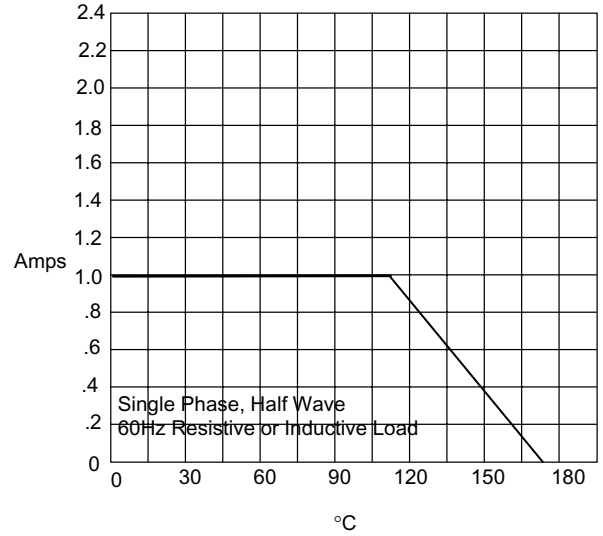

Average Forward Rectified Current - Amperes versus
Lead Temperature - $^\circ\text{C}$

Figure 3
Junction Capacitance

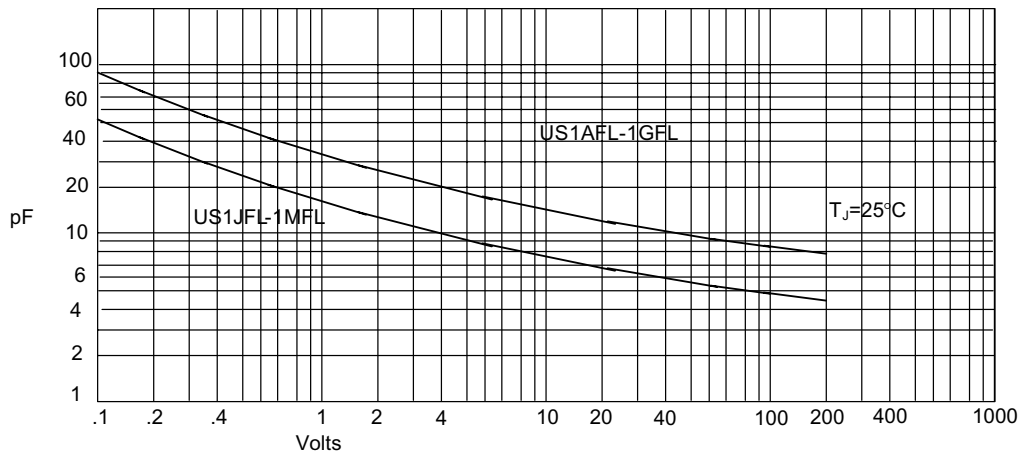

Junction Capacitance - pF versus
Reverse Voltage - Volts

US1AFL thru US1MFL



Micro Commercial Components

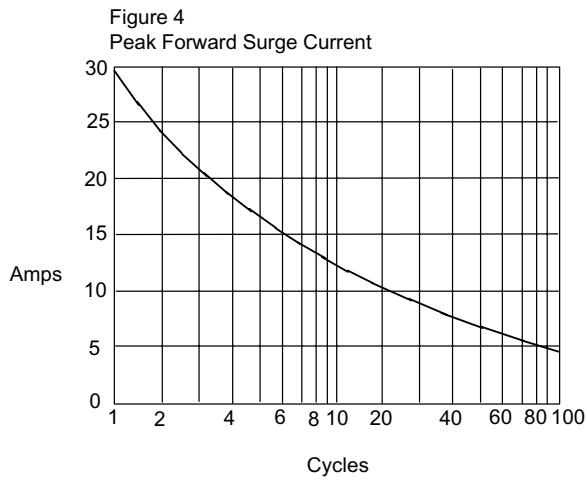

Peak Forward Surge Current - Amperes versus Number Of Cycles At 60Hz - Cycles

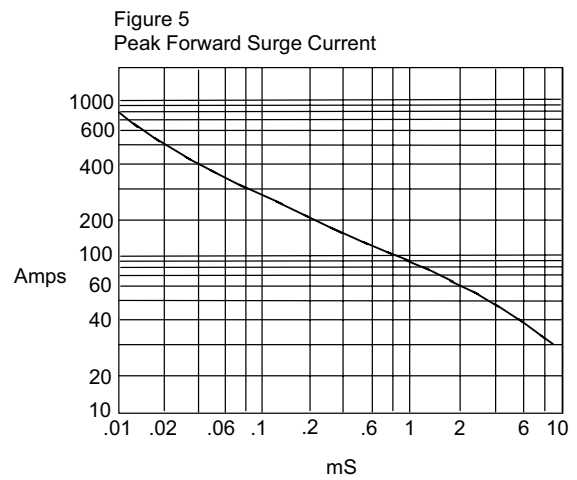

Peak Forward Surge Current - Amperes versus Pulse Duration - Milliseconds (mS)

Figure 6
Reverse Recovery Time Characteristic And Test Circuit Diagram

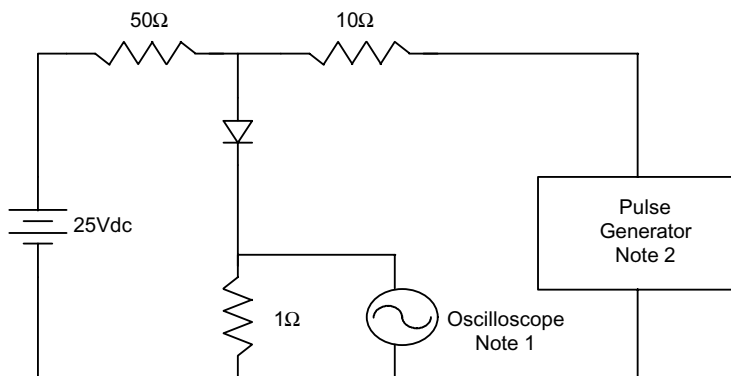

- Notes:
1. Rise Time = 7ns max.
Input impedance = 1 megohm, 22pF
 2. Rise Time = 10ns max.
Source impedance = 50 ohms
 3. Resistors are non-inductive

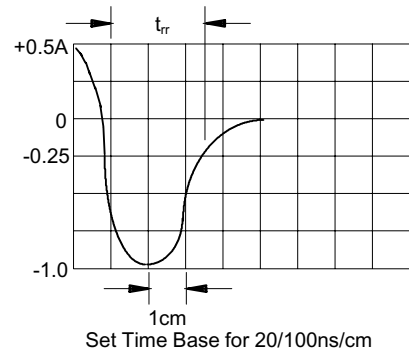



TM

Micro Commercial Components

Ordering Information :

Device	Packing
Part Number-TP	Tape&Reel: 10Kpcs/Reel

Note : Adding "-HF" suffix for halogen free, eg. Part Number-TP-HF

IMPORTANT NOTICE

Micro Commercial Components Corp. reserves the right to make changes without further notice to any product herein to make corrections, modifications , enhancements , improvements , or other changes . **Micro Commercial Components Corp .** does not assume any liability arising out of the application or use of any product described herein; neither does it convey any license under its patent rights ,nor the rights of others . The user of products in such applications shall assume all risks of such use and will agree to hold **Micro Commercial Components Corp .** and all the companies whose products are represented on our website, harmless against all damages.

LIFE SUPPORT

MCC's products are not authorized for use as critical components in life support devices or systems without the express written approval of Micro Commercial Components Corporation.

CUSTOMER AWARENESS

Counterfeiting of semiconductor parts is a growing problem in the industry. Micro Commercial Components (MCC) is taking strong measures to protect ourselves and our customers from the proliferation of counterfeit parts. MCC strongly encourages customers to purchase MCC parts either directly from MCC or from Authorized MCC Distributors who are listed by country on our web page cited below. Products customers buy either from MCC directly or from Authorized MCC Distributors are genuine parts, have full traceability, meet MCC's quality standards for handling and storage. **MCC will not provide any warranty coverage or other assistance for parts bought from Unauthorized Sources.** MCC is committed to combat this global problem and encourage our customers to do their part in stopping this practice by buying direct or from authorized distributors.

www.mccsemi.com