

T-39-11

INTERNATIONAL RECTIFIER

INTERNATIONAL RECTIFIER 

**HEXFET® TRANSISTORS IRFJ120**

**N-CHANNEL  
POWER MOSFETs**

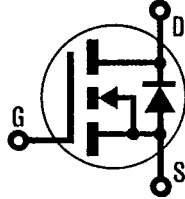

**IRFJ121**  
**IRFJ122**  
**IRFJ123**

**100 Volt, 0.3 Ohm HEXFET**

The HEXFET® technology is the key to International Rectifier's advanced line of power MOSFET transistors. The efficient geometry and unique processing of the HEXFET design achieve very low on-state resistance combined with high transconductance and great device ruggedness.

The HEXFET transistors also feature all of the well established advantages of MOSFETs such as voltage control, very fast switching, ease of paralleling, and temperature stability of the electrical parameters.

They are well suited for applications such as switching power supplies, motor controls, inverters, choppers, audio amplifiers, and high energy pulse circuits.

**Features:**

- Fast Switching
- Low Drive Current
- Ease of Paralleling
- Excellent Temperature Stability

**Product Summary**

Part Number	V <sub>DS</sub>	R <sub>DS(on)</sub>	I <sub>D</sub>
IRFJ120	100V	0.3Ω	8.0A
IRFJ121	60V	0.3Ω	8.0A
IRFJ122	100V	0.4Ω	7.0A
IRFJ123	60V	0.4Ω	7.0A

**CASE STYLE AND DIMENSIONS**

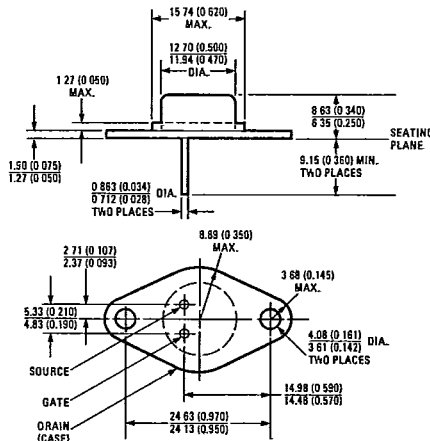
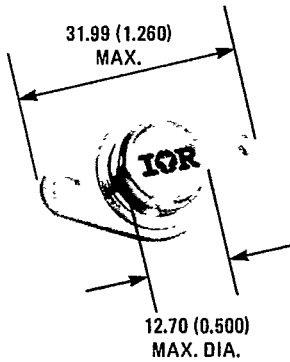

Conforms to JEDEC Case Style TO-213AA (TO-66)  
Dimensions in Millimeters and (Inches)

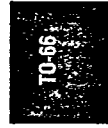

IRFJ120, IRFJ121, IRFJ122, IRFJ123 Devices

INTERNATIONAL RECTIFIER

Absolute Maximum Ratings

T-39-11

Parameter	IRFJ120	IRFJ121	IRFJ122	IRFJ123	Units
V <sub>DS</sub> Drain - Source Voltage ①	100	60	100	60	V
V <sub>DGR</sub> Drain - Gate Voltage (R <sub>GS</sub> = 20 K $\Omega$ ) ①	100	60	100	60	V
I <sub>D</sub> @ T <sub>C</sub> = 25°C Continuous Drain Current	8.0	8.0	7.0	7.0	A
I <sub>D</sub> @ T <sub>C</sub> = 100°C Continuous Drain Current	5.0	5.0	4.0	4.0	A
I <sub>DM</sub> Pulsed Drain Current ③	32	32	28	28	A
V <sub>GS</sub> Gate - Source Voltage	± 20				V
P <sub>D</sub> @ T <sub>C</sub> = 25°C Max. Power Dissipation	40 (See Fig. 14)				W
Linear Derating Factor	0.32 (See Fig. 14)				W/K ④
I <sub>LM</sub> Inductive Current, Clamped	(See Fig. 15 and 16) L = 100 $\mu$ H				A
T <sub>J</sub> Operating Junction and Storage Temperature Range	-55 to 150				°C
T <sub>stg</sub> Lead Temperature	300 (0.063 in. (1.6mm) from case for 10s)				°C

Electrical Characteristics @ T<sub>C</sub> = 25°C (Unless Otherwise Specified)

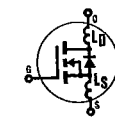
Parameter	Type	Min.	Typ.	Max.	Units	Test Conditions	
BV <sub>DSS</sub> Drain - Source Breakdown Voltage	IRFJ120	100	-	-	V	V <sub>GS</sub> = 0V I <sub>D</sub> = 250 $\mu$ A	
	IRFJ122	100	-	-	V		
	IRFJ121 IRFJ123	60	-	-	V		
V <sub>GS(th)</sub> Gate Threshold Voltage	ALL	2.0	-	4.0	V	V <sub>DS</sub> = V <sub>GS</sub> , I <sub>D</sub> = 250 $\mu$ A	
I <sub>GSS</sub> Gate - Source Leakage Forward	ALL	-	-	100	nA	V <sub>GS</sub> = 20V	
I <sub>GSS</sub> Gate - Source Leakage Reverse	ALL	-	-	100	nA	V <sub>GS</sub> = -20V	
I <sub>DSS</sub> Zero Gate Voltage Drain Current	ALL	-	-	250	$\mu$ A	V <sub>DS</sub> = Max. Rating, V <sub>GS</sub> = 0V	
		-	-	1000	$\mu$ A	V <sub>DS</sub> = Max. Rating x 0.8, V <sub>GS</sub> = 0V, T <sub>C</sub> = 125°C	
I <sub>D(on)</sub> On-State Drain Current ②	IRFJ120 IRFJ121	8.0	-	-	A	V <sub>DS</sub> > I <sub>D(on)</sub> x R <sub>DS(on)max.</sub> , V <sub>GS</sub> = 10V	
	IRFJ122 IRFJ123	7.0	-	-	A		
R <sub>DS(on)</sub> Static Drain-Source On-State Resistance ②	IRFJ120 IRFJ121	-	0.25	0.30	$\Omega$	V <sub>GS</sub> = 10V, I <sub>D</sub> = 4.0A	
	IRFJ122 IRFJ123	-	0.30	0.40	$\Omega$		
	ALL	1.5	2.9	-	S (①)		
g <sub>fs</sub> Forward Transconductance ②	ALL	1.5	2.9	-	S (①)	V <sub>DS</sub> > I <sub>D(on)</sub> x R <sub>DS(on)max.</sub> , I <sub>D</sub> = 4.0A	
C <sub>iss</sub> Input Capacitance	ALL	-	450	600	pF	V <sub>GS</sub> = 0V, V <sub>DS</sub> = 25V, f = 1.0 MHz See Fig. 10	
C <sub>oss</sub> Output Capacitance	ALL	-	200	400	pF		
C <sub>rss</sub> Reverse Transfer Capacitance	ALL	-	50	100	pF	V <sub>DD</sub> = 0.5 BV <sub>DSS</sub> , I <sub>D</sub> = 4.0A, Z <sub>o</sub> = 50 $\Omega$ See Fig. 17 (MOSFET switching times are essentially independent of operating temperature.)	
t <sub>d(on)</sub> Turn-On Delay Time	ALL	-	20	40	ns		
t <sub>r</sub> Rise Time	ALL	-	35	70	ns		
t <sub>d(off)</sub> Turn-Off Delay Time	ALL	-	50	100	ns		
t <sub>f</sub> Fall Time	ALL	-	35	70	ns		
Q <sub>g</sub> Total Gate Charge (Gate-Source Plus Gate-Drain)	ALL	-	10	15	nC	V <sub>GS</sub> = 10V, I <sub>D</sub> = 10A, V <sub>DS</sub> = 0.8 Max. Rating. See Fig. 18 for test circuit. (Gate charge is essentially independent of operating temperature.)	
Q <sub>gs</sub> Gate-Source Charge	ALL	-	6.0	-	nC		
Q <sub>gd</sub> Gate-Drain ("Miller") Charge	ALL	-	4.0	-	nC		
L <sub>D</sub> Internal Drain Inductance	ALL	-	5.0	-	nH	Measured between the contact screw on header that is closer to source and gate pins and center of die.	Modified MOSFET symbol showing the internal device inductances. 
L <sub>S</sub> Internal Source Inductance	ALL	-	12.5	-	nH	Measured from the source pin, 6 mm (0.25 in.) from header and source bonding pad.	

Thermal Resistance

Parameter	Value	Units	Notes
R <sub>thJC</sub> Junction-to-Case	3.1	K/W ④	
R <sub>thCS</sub> Case-to-Sink	0.2	K/W ④	Mounting surface flat, smooth, and greased.
R <sub>thJA</sub> Junction-to-Ambient	50	K/W ④	Typical socket mount

Source-Drain Diode Ratings and Characteristics

T-39-11

$I_S$	Continuous Source Current (Body Diode)	IRFJ120	—	—	8.0	A	Modified MOSFET symbol showing the integral reverse P-N junction rectifier.
		IRFJ121	—	—	7.0	A	
$I_{SM}$	Pulse Source Current (Body Diode) ③	IRFJ120	—	—	32	A	
		IRFJ121	—	—	28	A	
$V_{SD}$	Diode Forward Voltage ②	IRFJ120	—	—	2.5	V	$T_C = 25^\circ\text{C}, I_S = 8.0\text{A}, V_{GS} = 0\text{V}$
		IRFJ121	—	—	2.3	V	
$t_{rr}$	Reverse Recovery Time	ALL	—	280	—	ns	$T_J = 150^\circ\text{C}, I_F = 8.0\text{A}, dI_F/dt = 100\text{A}/\mu\text{s}$
$Q_{RR}$	Reverse Recovered Charge	ALL	—	1.6	—	$\mu\text{C}$	$T_J = 150^\circ\text{C}, I_F = 8.0\text{A}, dI_F/dt = 100\text{A}/\mu\text{s}$
$t_{on}$	Forward Turn-on Time	ALL	Intrinsic turn-on time is negligible. Turn-on speed is substantially controlled by $L_S + L_D$ .				

- ①  $T_J = 25^\circ\text{C}$  to  $150^\circ\text{C}$ .
- ② Pulse Test: Pulse width  $\leq 300\mu\text{s}$ , Duty Cycle  $\leq 2\%$ .
- ③ Repetitive Rating: Pulse width limited by max. junction temperature. See Transient Thermal Impedance Curve (Fig. 5).
- ④  $K/W = ^\circ\text{C}/\text{W}$   
 $W/K = \text{W}/^\circ\text{C}$

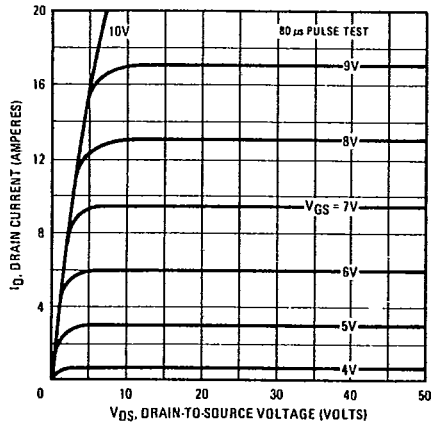

Fig. 1 - Typical Output Characteristics

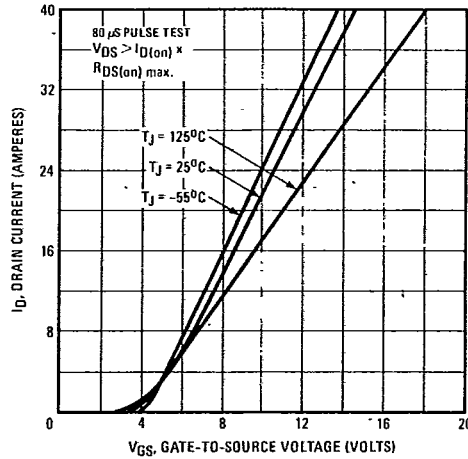

Fig. 2 - Typical Transfer Characteristics

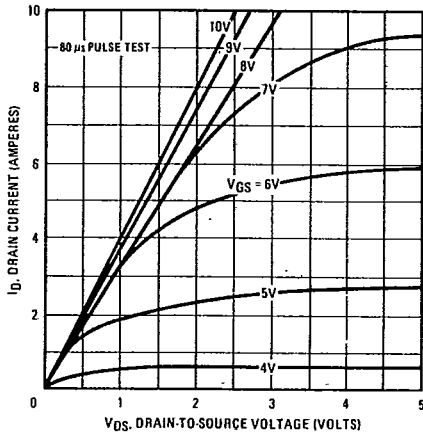

Fig. 3 - Typical Saturation Characteristics

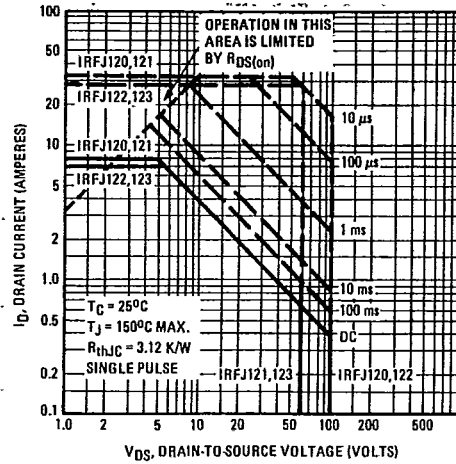

Fig. 4 - Maximum Safe Operating Area

T0-66

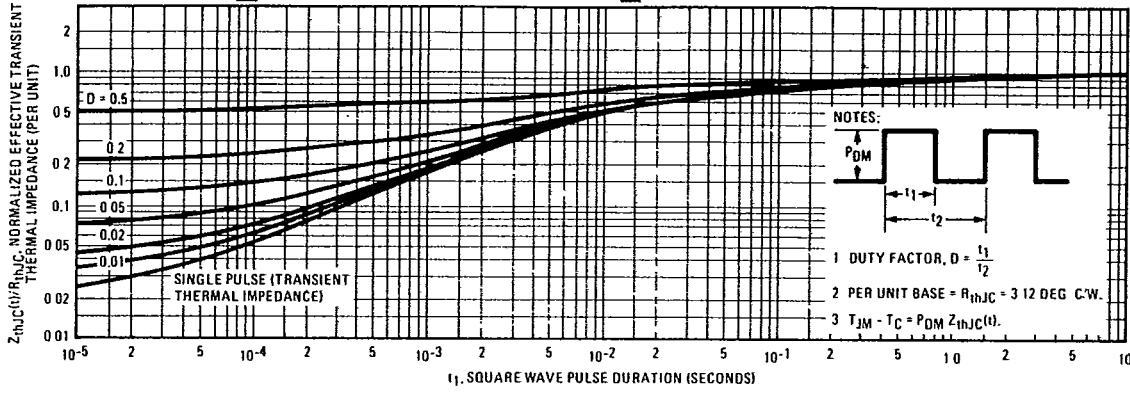

Fig. 5 – Maximum Effective Transient Thermal Impedance, Junction-to-Case Vs. Pulse Duration

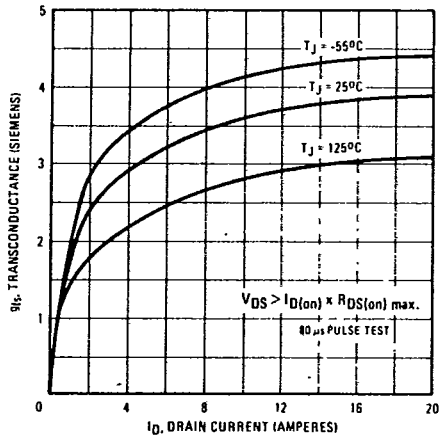

Fig. 6 – Typical Transconductance Vs. Drain Current

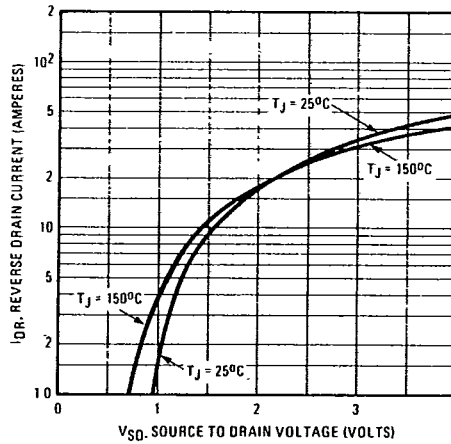

Fig. 7 – Typical Source-Drain Diode Forward Voltage

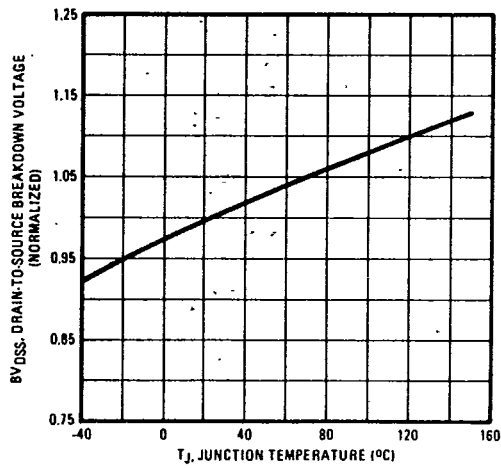

Fig. 8 – Breakdown Voltage Vs. Temperature

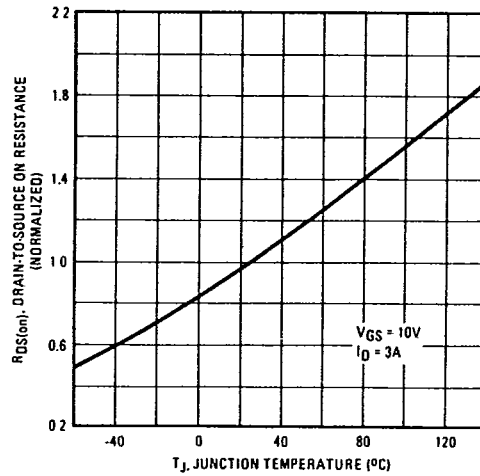

Fig. 9 – Normalized On-Resistance Vs. Temperature

IRFJ120, IRFJ121, IRFJ122, IRFJ123 Devices

INTERNATIONAL RECTIFIER

T-39-11

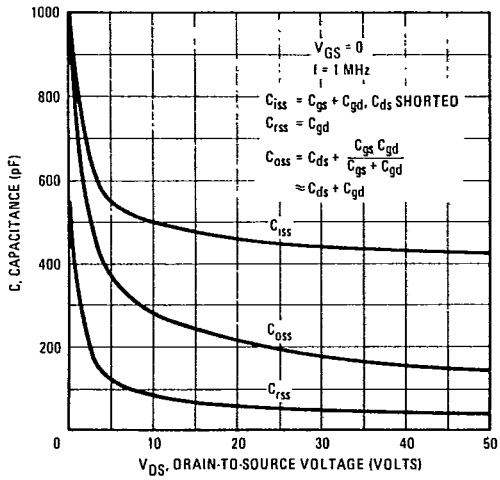

Fig. 10 - Typical Capacitance Vs. Drain-to-Source Voltage

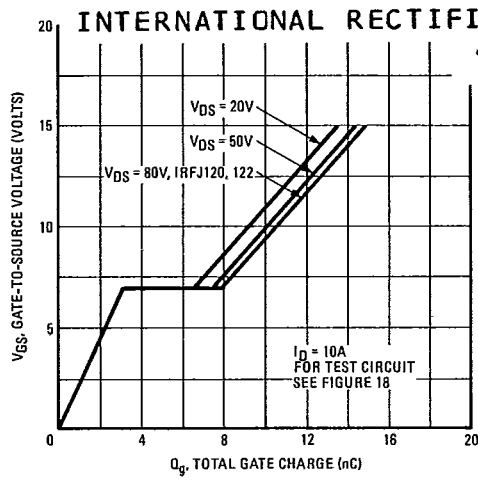

Fig. 11 - Typical Gate Charge Vs. Gate-to-Source Voltage

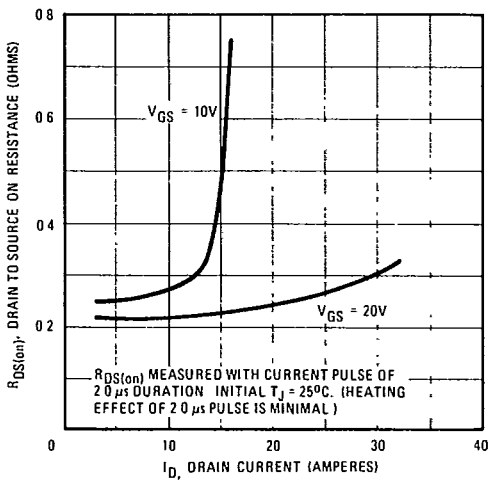

Fig. 12 - Typical On-Resistance Vs. Drain Current

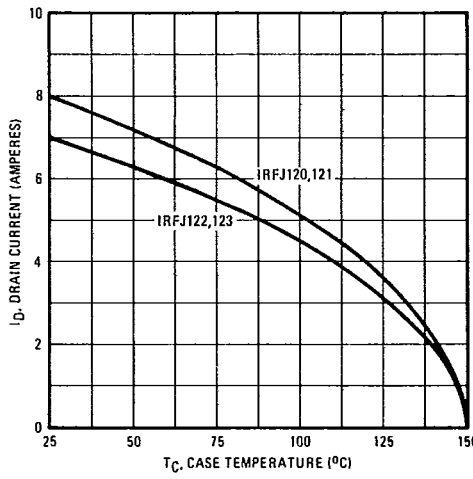

Fig. 13 - Maximum Drain Current Vs. Case Temperature

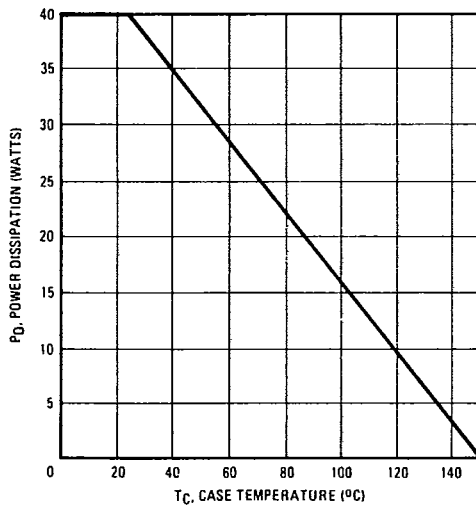

Fig. 14 - Power Vs. Temperature Derating Curve



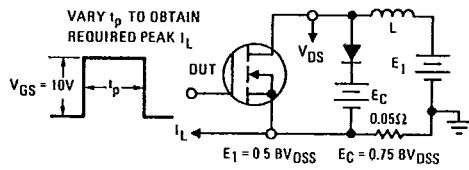

Fig. 15 - Clamped Inductive Test Circuit

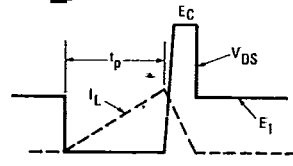

Fig. 16 - Clamped Inductive Waveforms

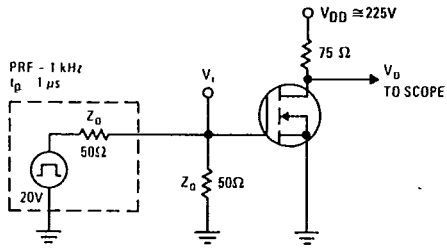

Fig. 17 - Switching Time Test Circuit

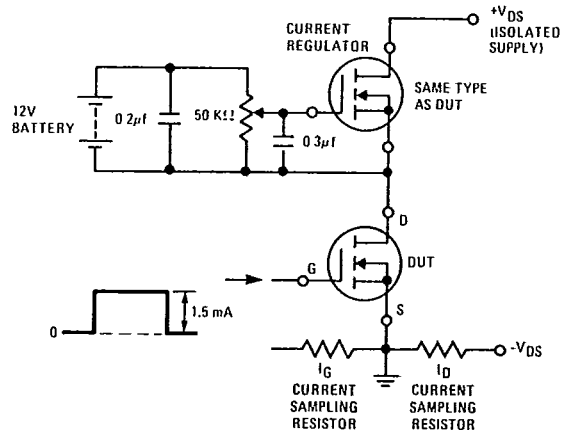

Fig. 18 - Gate Charge Test Circuit