

**OBSOLETE PRODUCT
POSSIBLE SUBSTITUTE PRODUCT
HGTG30N60B3**

54A, 600V, Rugged UFS Series N-Channel IGBT

This IGBT was designed for optimum performance in the demanding world of motor control operation as well as other high voltage switching applications. This device demonstrates RUGGED performance capability when subjected to harsh SHORT CIRCUIT WITHSTAND TIME (SCWT) conditions. The parts have ULTRAFast (UFS) switching speed while the on-state conduction losses have been kept at a low level.

The electrical specifications include typical Turn-On and Turn-Off dv/dt ratings. These ratings and the Turn-On ratings include the effect of the diode, in the test circuit (Figure 16). The data was obtained with the diode at the same T_J as the IGBT under test.

Formerly developmental type TA49048.

Ordering Information

PART NUMBER	PACKAGE	BRAND
HGTG27N60C3R	TO-247	27N60C3R

NOTE: When ordering, use the entire part number.

Symbol

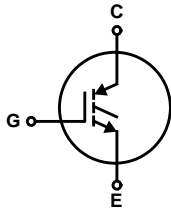

Features

- 54A, 600V, T_C = 25°C
- 600V Switching SOA Capability
- Typical Fall Time at T_J = 150°C 180ns
- Short Circuit Rating at T_J = 150°C 10μs
- Low Conduction Loss

Packaging

JEDEC STYLE TO-247

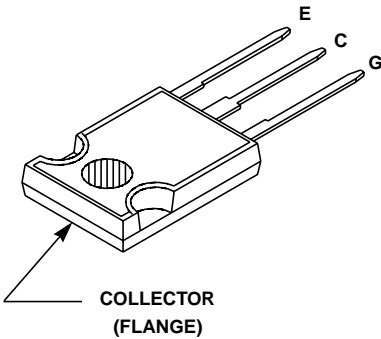

INTERSIL CORPORATION IGBT PRODUCT IS COVERED BY ONE OR MORE OF THE FOLLOWING U.S. PATENTS

4,364,073	4,417,385	4,430,792	4,443,931	4,466,176	4,516,143	4,532,534	4,587,713
4,598,461	4,605,948	4,620,211	4,631,564	4,639,754	4,639,762	4,641,162	4,644,637
4,682,195	4,684,413	4,694,313	4,717,679	4,743,952	4,783,690	4,794,432	4,801,986
4,803,533	4,809,045	4,809,047	4,810,665	4,823,176	4,837,606	4,860,080	4,883,767
4,888,627	4,890,143	4,901,127	4,904,609	4,933,740	4,963,951	4,969,027	

HGTG27N60C3R

Absolute Maximum Ratings $T_C = 25^\circ\text{C}$, Unless Otherwise Specified

	HGTG27N60C3R	UNITS
Collector to Emitter Voltage	BV_{CES}	600 V
Collector Current Continuous		
At $T_C = 25^\circ\text{C}$	I_{C25}	54 A
At $T_C = 110^\circ\text{C}$	I_{C110}	27 A
Collector Current Pulsed (Note 1)	I_{CM}	108 A
Gate to Emitter Voltage Continuous	V_{GES}	± 20 V
Gate to Emitter Voltage Pulsed	V_{GEM}	± 30 V
Switching Safe Operating Area at $T_J = 150^\circ\text{C}$ (Figure 12)	SSOA	108A at 600V
Power Dissipation Total at $T_C = 25^\circ\text{C}$	P_D	208 W
Power Dissipation Derating $T_C > 25^\circ\text{C}$		1.67 $W/^\circ\text{C}$
Reverse Voltage Avalanche Energy	E_{ARV}	100 mJ
Operating and Storage Junction Temperature Range	T_J, T_{STG}	-40 to 150 $^\circ\text{C}$
Maximum Lead Temperature for Soldering	T_L	260 $^\circ\text{C}$
Short Circuit Withstand Time (Note 2) at $V_{GE} = 15\text{V}$	t_{SC}	10 μs

CAUTION: Stresses above those listed in "Absolute Maximum Ratings" may cause permanent damage to the device. This is a stress only rating and operation of the device at these or any other conditions above those indicated in the operational sections of this specification is not implied.

NOTES:

1. Pulse width limited by maximum junction temperature.
2. $V_{CE(PK)} = 440\text{V}$, $T_J = 150^\circ\text{C}$, $R_G = 3\Omega$.

Electrical Specifications $T_C = 25^\circ\text{C}$, Unless Otherwise Specified

PARAMETER	SYMBOL	TEST CONDITIONS	MIN	TYP	MAX	UNITS
Collector to Emitter Breakdown Voltage	BV_{CES}	$I_C = 250\mu\text{A}$, $V_{GE} = 0\text{V}$	600	-	-	V
Emitter to Collector Breakdown Voltage	BV_{ECS}	$I_C = 10\text{mA}$, $V_{GE} = 0\text{V}$	15	-	-	V
Collector to Emitter Leakage Current	I_{CESD}	$V_{CE} = BV_{CES}$ $T_C = 25^\circ\text{C}$	-	-	250	μA
		$V_{CE} = BV_{CES}$ $T_C = 150^\circ\text{C}$	-	-	3.0	mA
Collector to Emitter Saturation Voltage	$V_{CE(SAT)}$	$I_C = I_{C110}$, $T_C = 25^\circ\text{C}$ $V_{GE} = 15\text{V}$	-	1.8	2.2	V
		$T_C = 150^\circ\text{C}$	-	2.1	2.5	V
Gate to Emitter Threshold Voltage	$V_{GE(TH)}$	$I_C = 250\mu\text{A}$, $V_{CE} = V_{GE}$	3.5	5.7	7.5	V
Gate to Emitter Leakage Current	I_{GES}	$V_{GE} = \pm 20\text{V}$	-	-	± 100	nA
Switching SOA (See Figure 12)	SSOA	$T_J = 150^\circ\text{C}$, $R_G = 3\Omega$ $V_{GE} = 15\text{V}$, $V_{CE(PK)} = 600\text{V}$ $L = 50\mu\text{H}$	108	-	-	A
Gate to Emitter Plateau Voltage	V_{GEP}	$I_C = I_{C110}$, $V_{CE} = 0.5 BV_{CES}$	-	9.0	-	V
On-State Gate Charge	$Q_{g(ON)}$	$I_C = I_{C110}$, $V_{GE} = 15\text{V}$ $V_{CE} = 0.5 BV_{ES}$	-	156	203	nC
		$V_{GE} = 20\text{V}$	-	212	277	nC
Current Turn-On Delay Time	$t_{d(ON)I}$	$T_J = 150^\circ\text{C}$ $I_{CE} = I_{C110}$ $V_{CE(PK)} = 0.8 BV_{CES}$ $V_{GE} = 15\text{V}$ $R_G = 3\Omega$ $L = 1\text{mH}$ Diode Used in Test Circuit RURP3060 at 150°C	-	38	-	ns
Current Rise Time	t_{rI}		-	30	-	ns
Current Turn-Off Delay Time	$t_{d(OFF)I}$		-	250	500	ns
Current Fall Time	t_{fI}		-	180	400	ns
Turn-Off Voltage dv/dt (Note 3)	dV_{CE}/dt		-	2	-	V/ns
Turn-On Voltage dv/dt (Note 3)	dV_{CE}/dt		-	7	-	V/ns
Turn-On Energy (Note 4)	E_{ON}		-	2.3	-	mJ
Turn-Off Energy (Note 5)	E_{OFF}		-	2.0	-	mJ

HGTG27N60C3R

Electrical Specifications $T_C = 25^\circ\text{C}$, Unless Otherwise Specified

PARAMETER	SYMBOL	TEST CONDITIONS	MIN	TYP	MAX	UNITS
Thermal Resistance	$R_{\theta JC}$		-	-	0.6	$^\circ\text{C/W}$

NOTES:

- dV_{CE}/dt depends on the diode used and the temperature of the diode. dV_{CE}/dt is measured from 90% to 10% of the voltage.
- Turn-On Energy Loss (E_{ON}) includes diode losses and is defined as the integral of the instantaneous power loss starting at the leading edge of the input pulse and ending at the point where the collector voltage equals $V_{CE(ON)}$. This value of E_{ON} was obtained with a RURP3060 diode at $T_J = 150^\circ\text{C}$. A different diode or temperature will result in a different E_{ON} . For example with diode at $T_J = 25^\circ\text{C}$ E_{ON} is about one half the value at 150°C .
- Turn-Off Energy Loss (E_{OFF}) is defined as the integral of the instantaneous power loss starting at the trailing edge of the input pulse and ending at the point where the collector current equals zero ($I_{CE} = 0\text{A}$). All devices were tested per JEDEC standard No. 24-1 Method for Measurement of Power Device Turn-Off Switching Loss. This test method produces the true total Turn-Off Energy Loss.

Typical Performance Curves

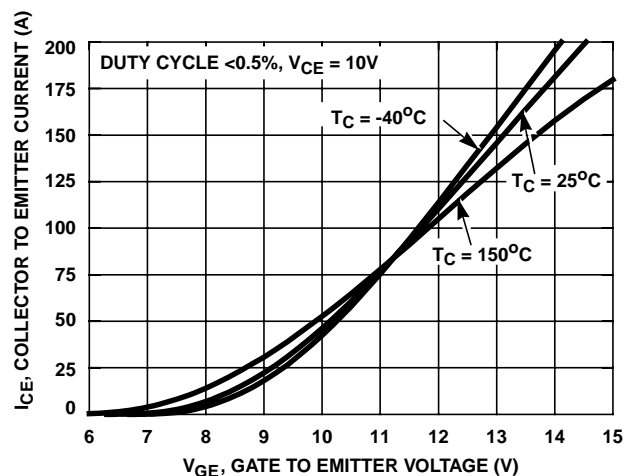

FIGURE 1. TRANSFER CHARACTERISTICS

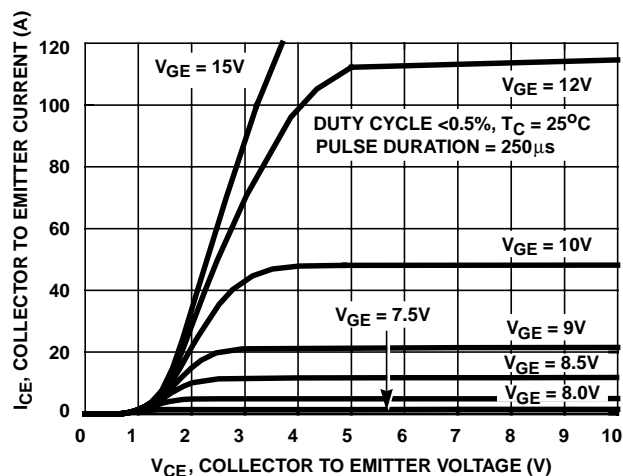

FIGURE 2. SATURATION CHARACTERISTICS

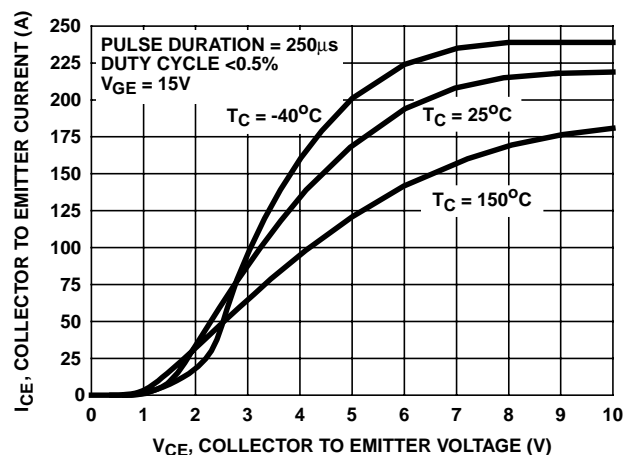

FIGURE 3. COLLECTOR TO EMITTER ON-STATE VOLTAGE

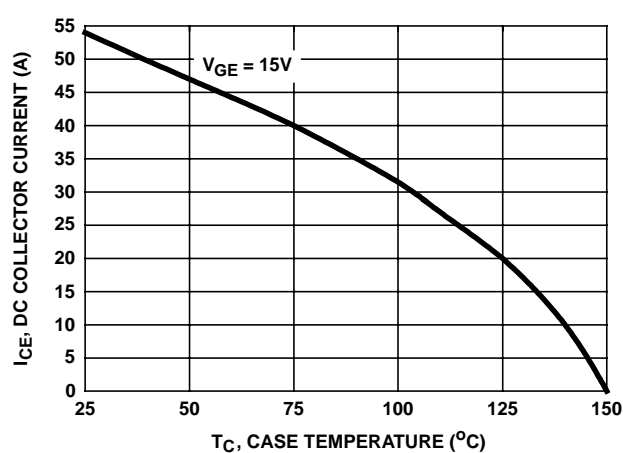

FIGURE 4. DC COLLECTOR CURRENT vs CASE TEMPERATURE

Typical Performance Curves (Continued)

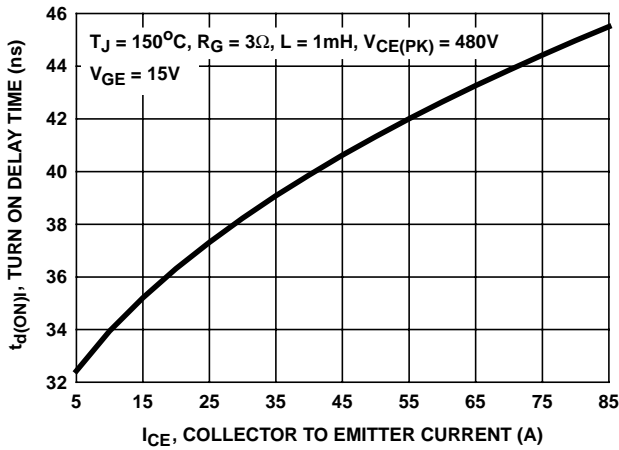

FIGURE 5. TURN ON DELAY TIME vs COLLECTOR TO EMITTER CURRENT

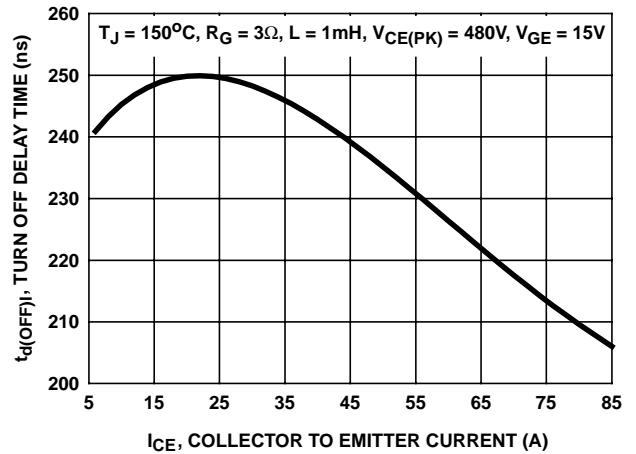

FIGURE 6. TURN OFF DELAY TIME vs COLLECTOR TO EMITTER CURRENT

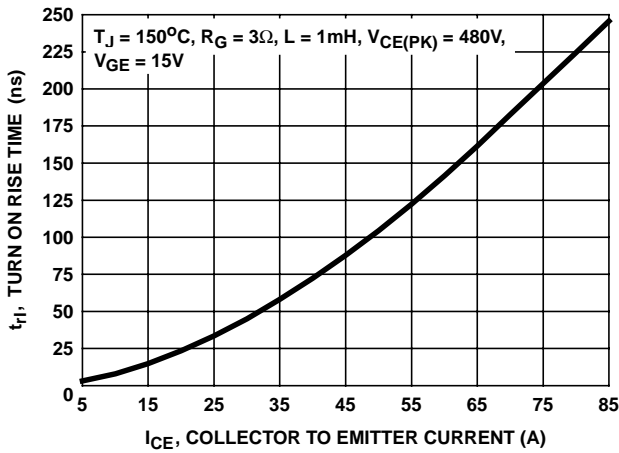

FIGURE 7. TURN ON RISE TIME vs COLLECTOR TO EMITTER CURRENT

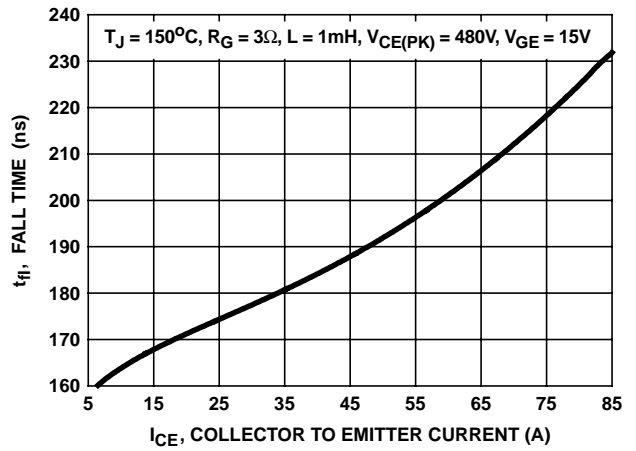

FIGURE 8. TURN OFF FALL TIME vs COLLECTOR TO EMITTER CURRENT

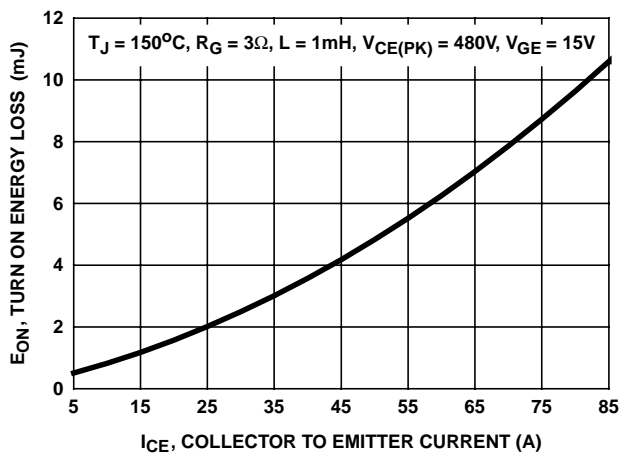

FIGURE 9. TURN ON ENERGY LOSS vs COLLECTOR TO EMITTER CURRENT

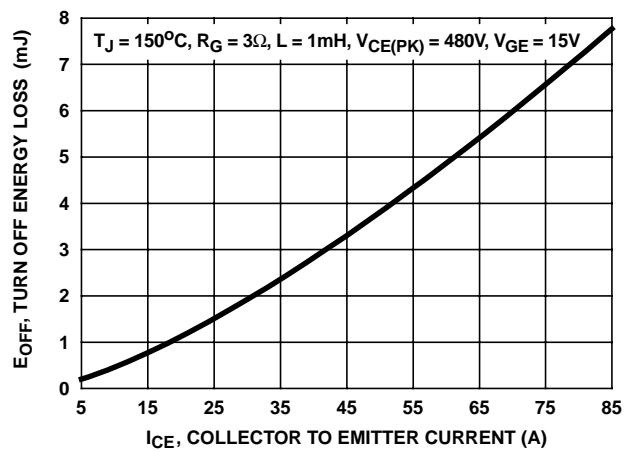

FIGURE 10. TURN OFF ENERGY LOSS vs COLLECTOR TO EMITTER CURRENT

Typical Performance Curves (Continued)

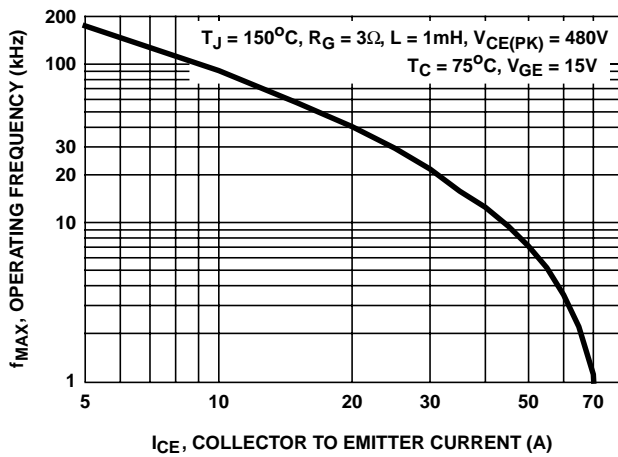

FIGURE 11. OPERATING FREQUENCY vs COLLECTOR TO EMITTER CURRENT

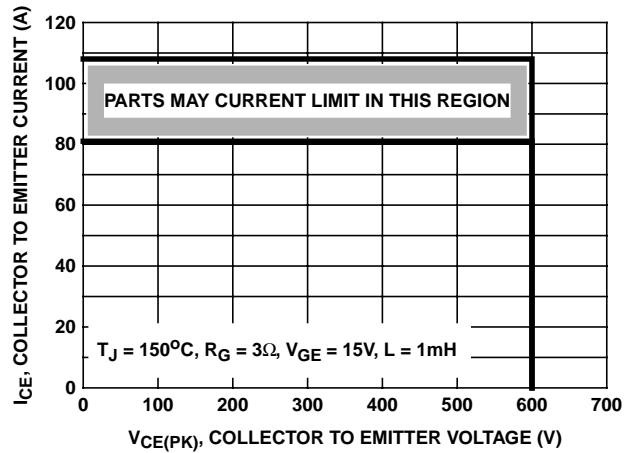

FIGURE 12. SWITCHING SAFE OPERATING AREA

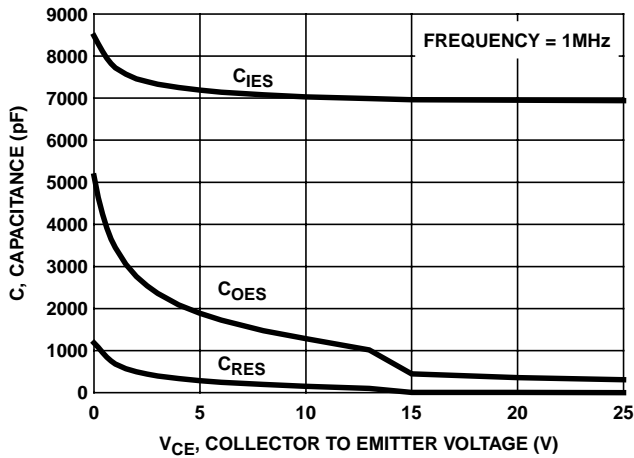

FIGURE 13. CAPACITANCE vs COLLECTOR TO EMITTER VOLTAGE

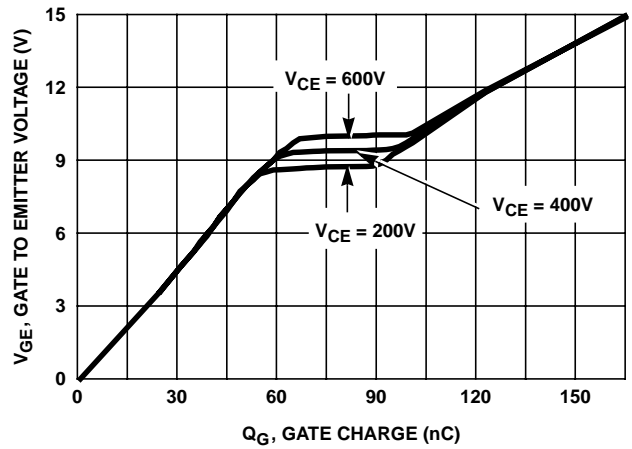

FIGURE 14. GATE CHARGE WAVEFORMS

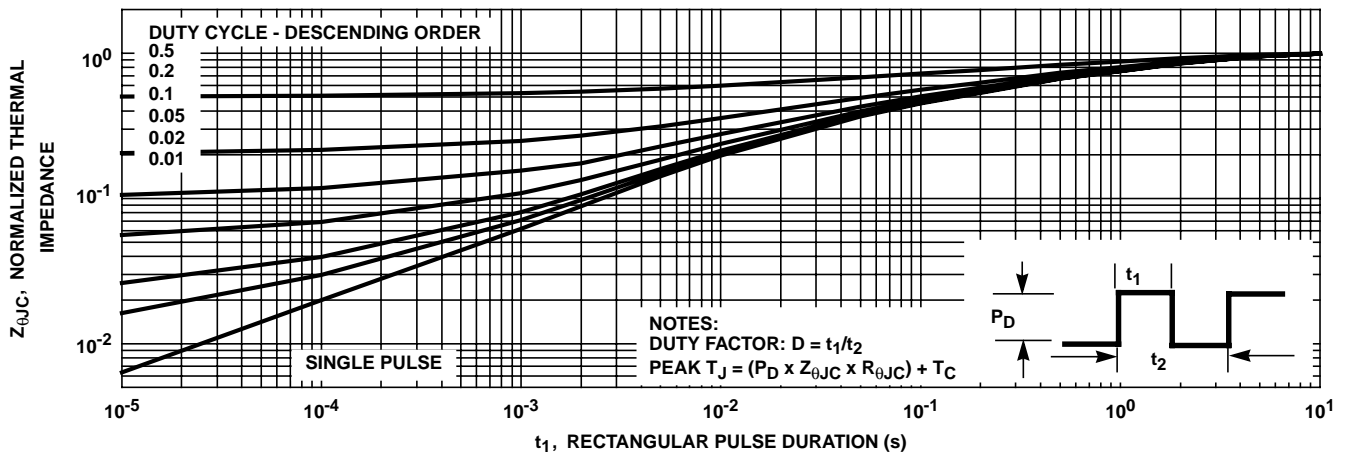

FIGURE 15. IGBT NORMALIZED TRANSIENT THERMAL IMPEDANCE, JUNCTION TO CASE

Test Circuit and Waveforms

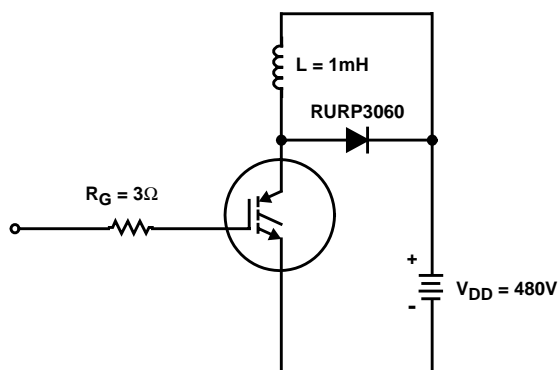

FIGURE 16. INDUCTIVE SWITCHING TEST CIRCUIT

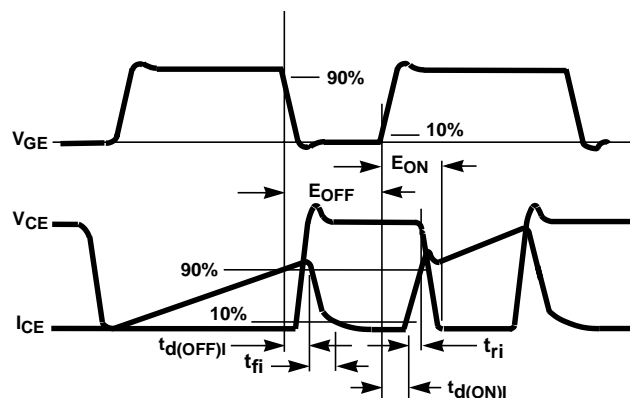

FIGURE 17. SWITCHING TEST WAVEFORMS

Handling Precautions for IGBTs

Insulated Gate Bipolar Transistors are susceptible to gate-insulation damage by the electrostatic discharge of energy through the devices. When handling these devices, care should be exercised to assure that the static charge built in the handler's body capacitance is not discharged through the device. With proper handling and application procedures, however, IGBTs are currently being extensively used in production by numerous equipment manufacturers in military, industrial and consumer applications, with virtually no damage problems due to electrostatic discharge. IGBTs can be handled safely if the following basic precautions are taken:

1. Prior to assembly into a circuit, all leads should be kept shorted together either by the use of metal shorting springs or by the insertion into conductive material such as "ECCOSORBD™ LD26" or equivalent.
2. When devices are removed by hand from their carriers, the hand being used should be grounded by any suitable means - for example, with a metallic wristband.
3. Tips of soldering irons should be grounded.
4. Devices should never be inserted into or removed from circuits with power on.
5. **Gate Voltage Rating** - Never exceed the gate-voltage rating of V_{GEM} . Exceeding the rated V_{GE} can result in permanent damage to the oxide layer in the gate region.
6. **Gate Termination** - The gates of these devices are essentially capacitors. Circuits that leave the gate open-circuited or floating should be avoided. These conditions can result in turn-on of the device due to voltage buildup on the input capacitor due to leakage currents or pickup.
7. **Gate Protection** - These devices do not have an internal monolithic Zener diode from gate to emitter. If gate protection is required an external Zener is recommended.

All Intersil semiconductor products are manufactured, assembled and tested under **ISO9000** quality systems certification.

Intersil semiconductor products are sold by description only. Intersil Corporation reserves the right to make changes in circuit design and/or specifications at any time without notice. Accordingly, the reader is cautioned to verify that data sheets are current before placing orders. Information furnished by Intersil is believed to be accurate and reliable. However, no responsibility is assumed by Intersil or its subsidiaries for its use; nor for any infringements of patents or other rights of third parties which may result from its use. No license is granted by implication or otherwise under any patent or patent rights of Intersil or its subsidiaries.

For information regarding Intersil Corporation and its products, see web site www.intersil.com

Operating Frequency Information

Operating frequency information for a typical device (Figure 11) is presented as a guide for estimating device performance for a specific application. Other typical frequency vs collector current (I_{CE}) plots are possible using the information shown for a typical unit in Figures 3, 5, 6, 9 and 10. The operating frequency plot (Figure 11) of a typical device shows f_{MAX1} or f_{MAX2} whichever is smaller at each point. The information is based on measurements of a typical device and is bounded by the maximum rated junction temperature.

f_{MAX1} is defined by $f_{MAX1} = 0.05 / (t_{d(OFF)} + t_{d(ON)})$. Deadtime (the denominator) has been arbitrarily held to 10% of the on-state time for a 50% duty factor. Other definitions are possible. $t_{d(OFF)}$ and $t_{d(ON)}$ are defined in Figure 17. Device turn-off delay can establish an additional frequency limiting condition for an application other than T_{JM} . $t_{d(OFF)}$ is important when controlling output ripple under a lightly loaded condition.

f_{MAX2} is defined by $f_{MAX2} = (P_D - P_C) / (E_{OFF} + E_{ON})$. The allowable dissipation (P_D) is defined by $P_D = (T_{JM} - T_C) / R_{\theta JC}$. The sum of device switching and conduction losses must not exceed P_D . A 50% duty factor was used (Figure 11) and the conduction losses (P_C) are approximated by $P_C = (V_{CE} \times I_{CE}) / 2$ shown in Figure 17.

E_{ON} is the integral of the instantaneous power loss ($I_{CE} \times V_{CE}$) during turn-on and E_{OFF} is the integral of the instantaneous power loss ($I_{CE} \times V_{CE}$) during turn-off. All tail losses are included in the calculation for E_{OFF} ; i.e., the collector current equals zero ($I_{CE} = 0$).