

## Product Summary

$V_{RRM}$ (V)	$I_O$ (A)	$V_F$ (MAX) (V) @ +25°C	$I_R$ (MAX) (mA) @ +25°C
40	2	0.5	0.5

## Description

The APD240 is a low voltage dual Schottky rectifier suited for switch mode power supplies and other power converters. This device is intended for use in medium voltage operation, and particularly, in high frequency circuits where low switching losses and low noise are required

The APD240 is available in standard DO-214AC, DO-41, DO-15 and SOD-123 packages.

## Applications

- Low Voltage High Frequency Inverters
- DC-DC Converters
- Free Wheeling
- Polarity Protection

## Features

- Low Forward Voltage: 0.5V @ +25°C
- High Surge Current Capacity
- +125°C Operating Junction Temperature
- 2A Total
- Guard-Ring for Stress Protection
- Pb-free Package is Available
- DO-41, DO-15
  - **Lead-Free Finish; RoHS Compliant (Notes 1 & 2)**
- Available in "Green" Packages: DO-41, DO-15, DO-214AC, SOD-123
  - **Lead-Free Finish; RoHS Compliant (Notes 1 & 2)**
  - **Halogen and Antimony Free. "Green" Device (Note 3)**

## Mechanical Data

- Case: DO-41, DO-15, DO-214AC, SOD-123
- Case Material: Molded Plastic, "Green" Molding Compound. UL Flammability Classification Rating 94V-0
- Moisture Sensitivity: Level 1 per J-STD-020
- Terminals: Finish - Matte Tin Annealed over Copper Leadframe. Solderable per MIL-STD-202, Method 208
- Weight
  - DO-41 – 0.33Grams (Approximately)
  - DO-15 – 0.39Grams (Approximately)
  - DO-214AC – 0.062Grams (Approximately)
  - SOD-123 – 0.016Grams (Approximately)

**DO-41**

**DO-15**

**DO-214AC**

**SOD-123**

- Notes:
1. EU Directive 2002/95/EC (RoHS) & 2011/65/EU (RoHS 2) compliant. All applicable RoHS exemptions applied.
  2. See [http://www.diodes.com/quality/lead\\_free.html](http://www.diodes.com/quality/lead_free.html) for more information about Diodes Incorporated's definitions of Halogen- and Antimony-free, "Green" and Lead-free.
  3. Halogen- and Antimony-free "Green" products are defined as those which contain <900ppm bromine, <900ppm chlorine (<1500ppm total Br + Cl) and <1000ppm antimony compounds.

**Pin Assignments**

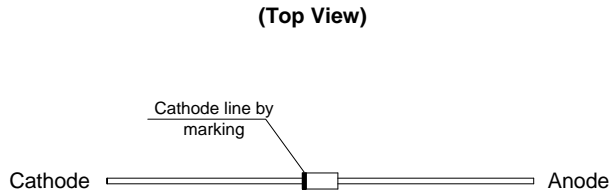

**DO-41 / DO-15**

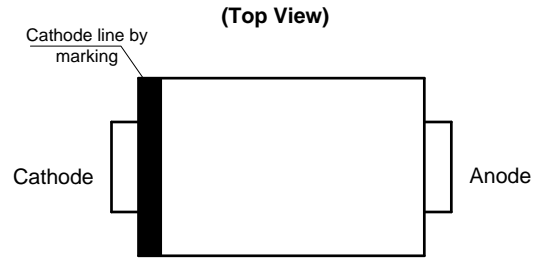

**DO-214AC**

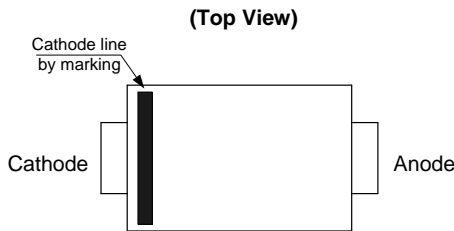

**SOD-123**

**Ordering Information** (Note 4)

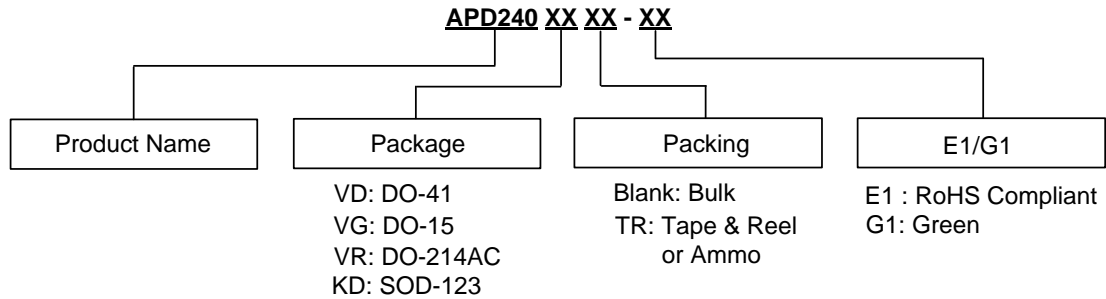

Note 4: Diodes IC's Pb-free products, as designated with "E1" suffix in the part number, are RoHS compliant. Products with "G1" suffix are available in green packages.



Package	Temperature Range	Part Number	Marking ID	Packing
DO-41	-65 to +125°C	APD240VD-E1	D240VD	1000/Bulk
DO-41	-65 to +125°C	APD240VD-G1	240VDG	1000/Bulk
DO-41	-65 to +125°C	APD240VDTR-E1	D240VD	2500/Ammo
DO-41	-65 to +125°C	APD240VDTR-G1	240VDG	2500/Ammo
DO-15	-65 to +125°C	APD240VG-E1	D240VG	500/Bulk
DO-15	-65 to +125°C	APD240VG-G1	240VGG	500/Bulk
DO-15	-65 to +125°C	APD240VGTR-E1	D240VG	1500/Ammo
DO-15	-65 to +125°C	APD240VGTR-G1	240VGG	1500/Ammo

**Ordering Information** (Cont. Note 4)



Package	Temperature Range	Part Number	Marking ID	Packing
DO-214AC	-65 to +125°C	APD240VRTR-G1	240VRG	7500/Tape & Reel
SOD-123	-65 to +125°C	APD240KDTR-G1	G11	3000/Tape & Reel

**Marking Information**

(1) DO-41/DO-15

(Top View)



First Line: Logo and Date Code  
 Y: Year  
 WW: Work Week of Molding  
 A: Assembly House Code  
 Second Line: Marking ID  
 (See Ordering Information)

(2) DO-214AC

(Top View)



First Line: Logo and Date Code  
 Y: Year  
 WW: Work Week of Molding  
 A: Assembly House Code  
 Second Line: Marking ID  
 (See Ordering Information)

### Marking Information (Cont.)

(3) SOD-123

(Top View)

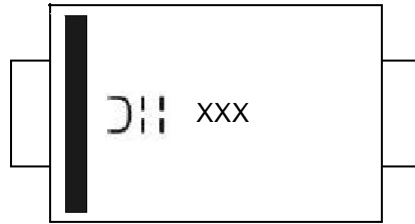

First Line: Logo and Marking ID  
(See Ordering Information)

### Maximum Ratings ( $T_A = +25^\circ\text{C}$ , unless otherwise noted.) (Note 5)

Characteristic	Symbol	Rating	Unit
Maximum Repetitive Peak Reverse Voltage	$V_{RRM}$	40	V
Maximum DC Blocking Voltage	$V_{DC}$	40	V
Maximum RMS Voltage	$V_{RMS}$	28	V
Average Rectified Forward Current 0.375 " (9.5mm) Lead Length (See Figure 1)	$I_{F(AV)}$	2.0	A
Non-Repetitive Peak Forward Surge Current 8.3ms Single Half Sine-wave on Rated Load	$I_{FSM}$	50	A
Operating Junction Temperature Range (Note 6)	$T_J$	-65 to +125	$^\circ\text{C}$
Storage Temperature Range	$T_{STG}$	-65 to +150	$^\circ\text{C}$

Notes: 5. Stresses greater than those listed under "Absolute Maximum Ratings" may cause permanent damage to the device. These are stress ratings only, and functional operation of the device at these or any other conditions beyond those indicated under "Recommended Operating Conditions" is not implied. Exposure to "Absolute Maximum Ratings" for extended periods may affect device reliability.

6. The heat generated must be less than the thermal conductivity from Junction to Ambient:  $dP_D/dT_J < 1/\theta_{JA}$ .

### Thermal Characteristics ( $T_A = +25^\circ\text{C}$ , unless otherwise noted.)

Characteristic	Symbol	Rating		Unit
		DO-41/DO-15	DO-214AC	
Typical Thermal Resistance (Note 7)	$R\theta_{JA}$	52	90	$^\circ\text{C/W}$
		200		

Note 7: Device mounted on heat sink, with minimum recommended pad layout per <http://www.diodes.com>

### Electrical Characteristics ( $T_A = +25^\circ\text{C}$ , unless otherwise noted.)

Characteristic	Symbol	Rating	Unit	Test Condition
Forward Voltage @ $I_F=2.0\text{A}$	$V_F$	0.5	V	-
Reverse Current @ Rated $V_R$ (Note 8)	$I_R$	0.5	mA	$T_A=+25^\circ\text{C}$
		10		$T_A=+100^\circ\text{C}$

Note 8: Short duration pulse test used to minimize self-heating effect, Pulse Test: 300 $\mu\text{s}$  pulse width, 1.0% duty cycle.

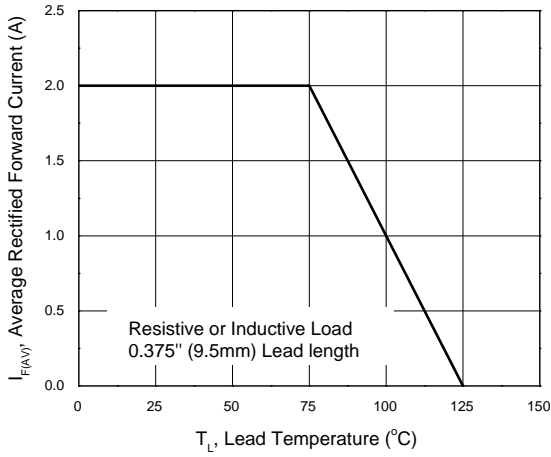

Figure 1. Forward Current Derating Curve

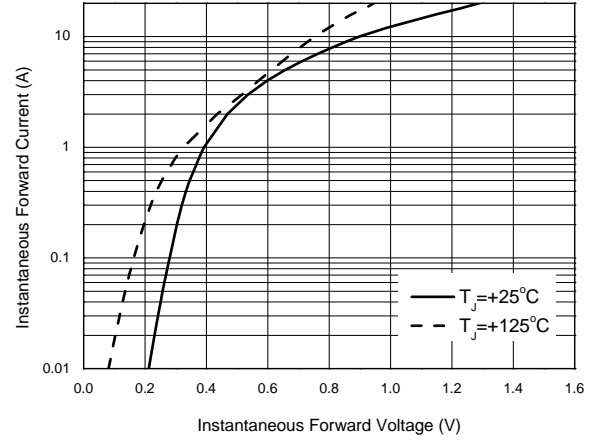

Figure 2. Typical Instantaneous Forward Characteristics

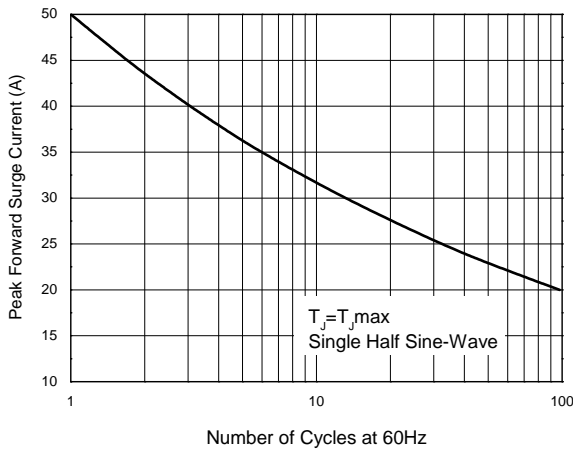

Figure 3. Maximum Non-Repetitive Peak Forward Surge Current

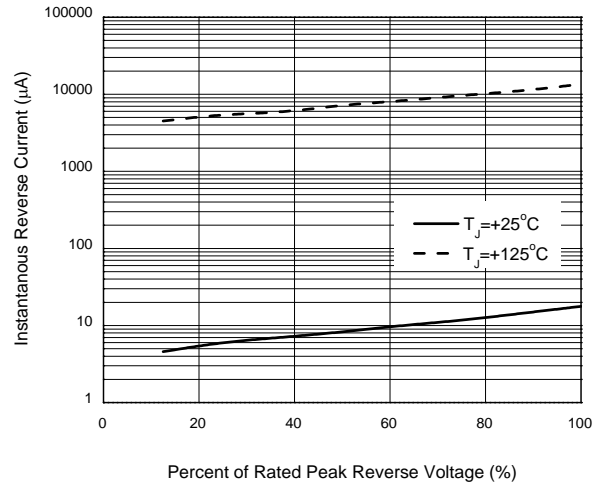

Figure 4. Typical Reverse Characteristics

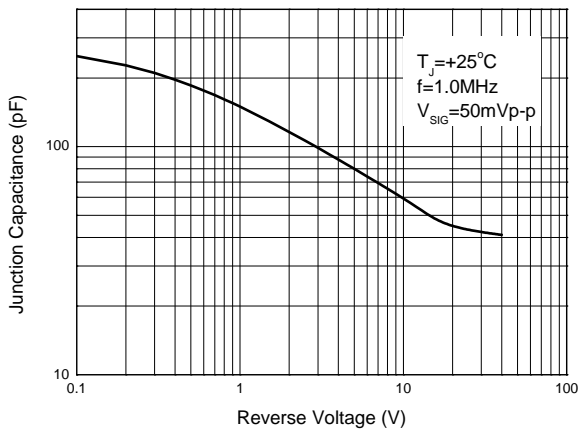
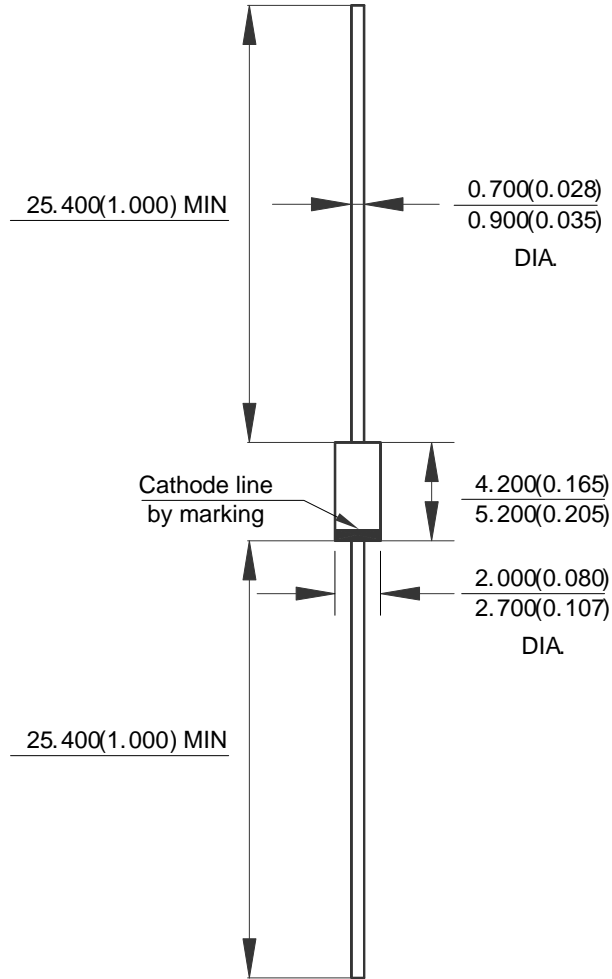

Figure 5. Typical Junction Capacitance

**Package Outline Dimensions** (All dimensions in mm(inch).)

(1) Package Type: DO-41



**Package Outline Dimensions** (Cont. All dimensions in mm(inch).)

(2) Package Type: DO-15

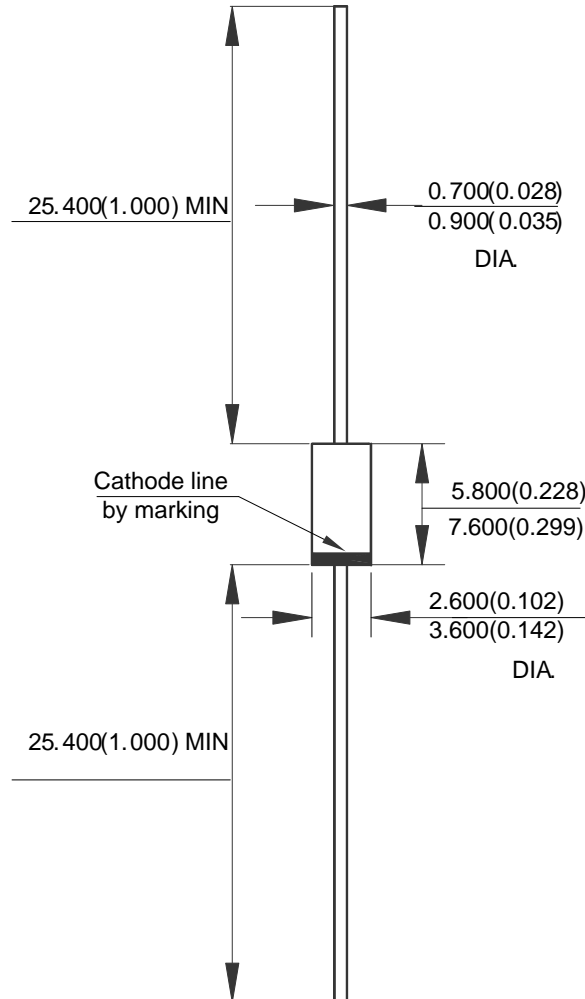

**Package Outline Dimensions** (Cont. All dimensions in mm(inch).)

(3) Package Type: DO-214AC

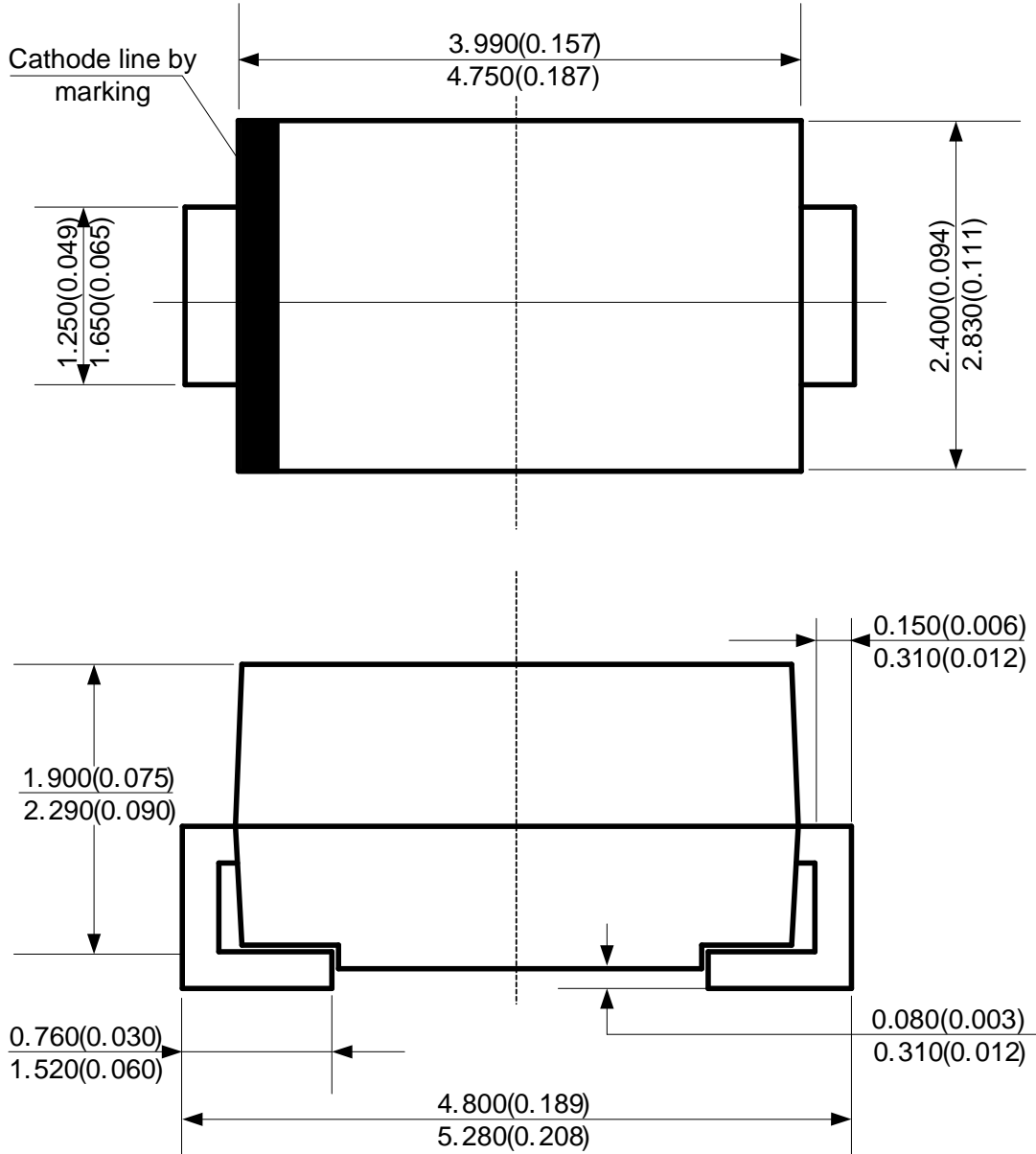



**Package Outline Dimensions** (Cont. All dimensions in mm(inch).)

(4) Package Type: SOD-123

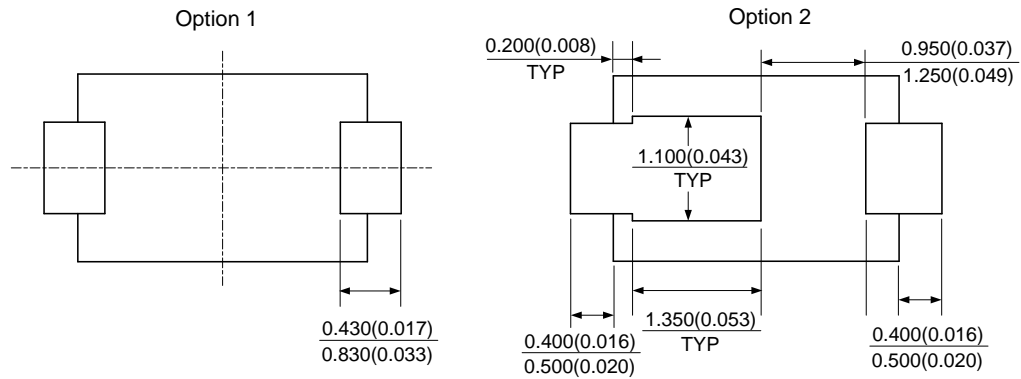
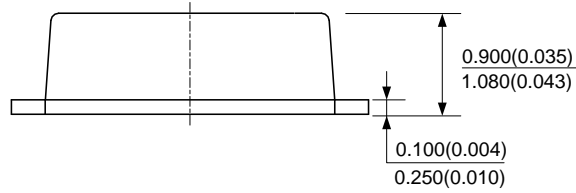
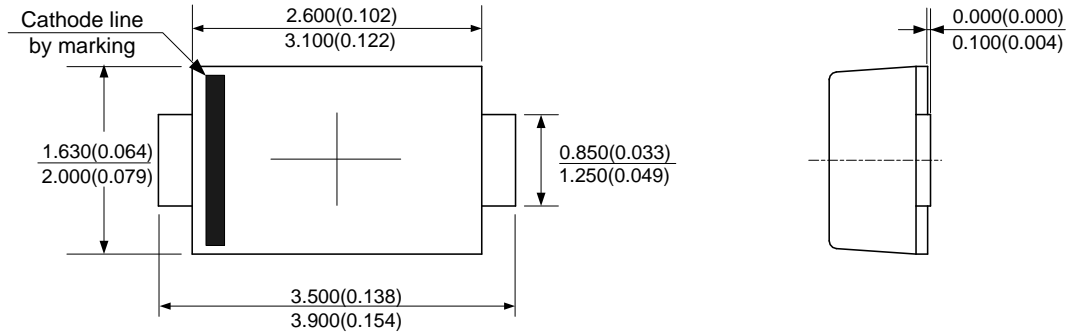

**Suggested Pad Layout**

(1) Package Type: DO-214AC

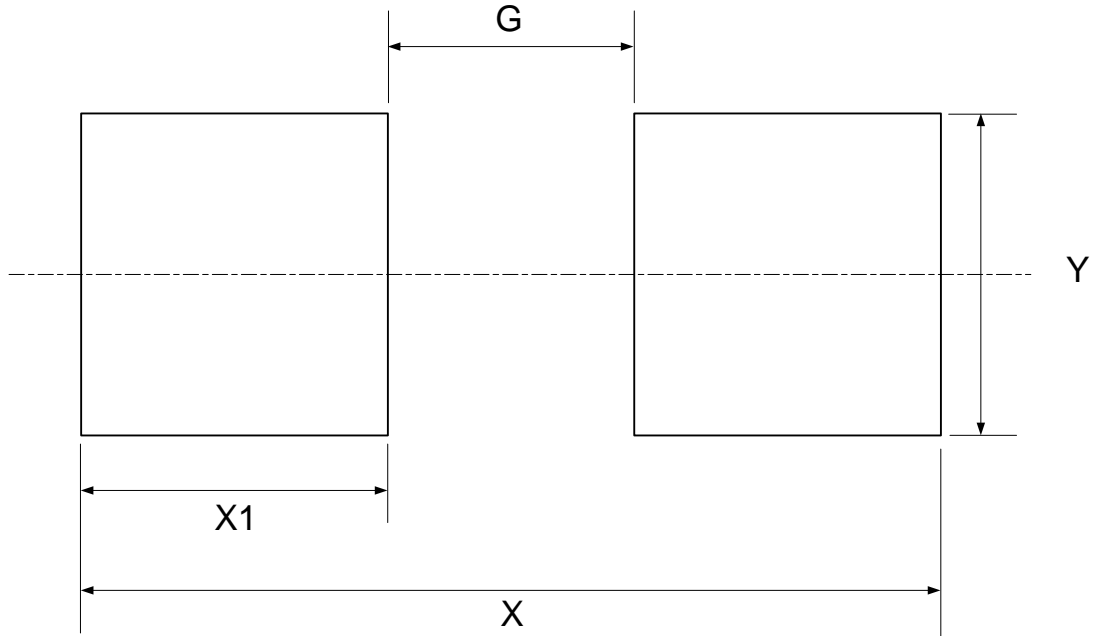

Dimensions	Y (mm)/(inch)	X1 (mm)/(inch)	G (mm)/(inch)	X (mm)/(inch)
Value	2.100/0.083	2.000/0.079	1.600/0.063	5.600/0.220

**Suggested Pad Layout** (Cont.)

(2) Package Type: SOD-123

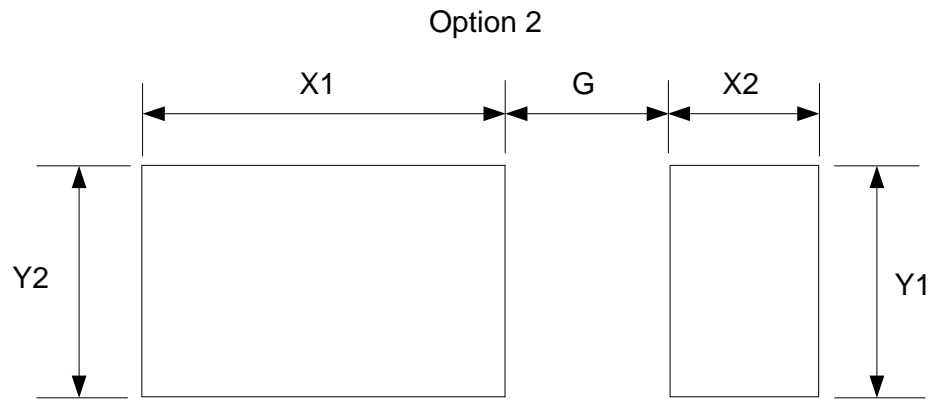
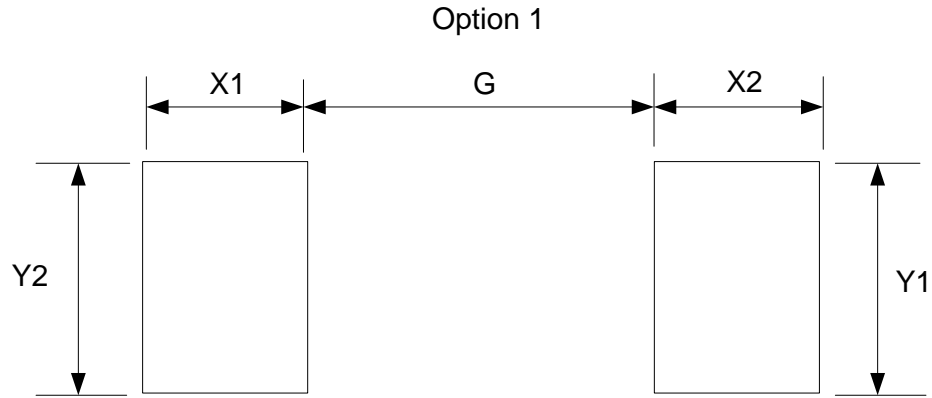

Dimensions	G (mm)/(inch)	X1 (mm)/(inch)	X2 (mm)/(inch)	Y1 (mm)/(inch)	Y2 (mm)/(inch)
Option1	2.100/0.083	1.000/0.039	1.000/0.039	1.400/0.055	1.400/0.055
Option2	1.000/0.039	2.200/0.087	0.900/0.035	1.400/0.055	1.400/0.055

**IMPORTANT NOTICE**

DIODES INCORPORATED MAKES NO WARRANTY OF ANY KIND, EXPRESS OR IMPLIED, WITH REGARDS TO THIS DOCUMENT, INCLUDING, BUT NOT LIMITED TO, THE IMPLIED WARRANTIES OF MERCHANTABILITY AND FITNESS FOR A PARTICULAR PURPOSE (AND THEIR EQUIVALENTS UNDER THE LAWS OF ANY JURISDICTION).

Diodes Incorporated and its subsidiaries reserve the right to make modifications, enhancements, improvements, corrections or other changes without further notice to this document and any product described herein. Diodes Incorporated does not assume any liability arising out of the application or use of this document or any product described herein; neither does Diodes Incorporated convey any license under its patent or trademark rights, nor the rights of others. Any Customer or user of this document or products described herein in such applications shall assume all risks of such use and will agree to hold Diodes Incorporated and all the companies whose products are represented on Diodes Incorporated website, harmless against all damages.

Diodes Incorporated does not warrant or accept any liability whatsoever in respect of any products purchased through unauthorized sales channel. Should Customers purchase or use Diodes Incorporated products for any unintended or unauthorized application, Customers shall indemnify and hold Diodes Incorporated and its representatives harmless against all claims, damages, expenses, and attorney fees arising out of, directly or indirectly, any claim of personal injury or death associated with such unintended or unauthorized application.

Products described herein may be covered by one or more United States, international or foreign patents pending. Product names and markings noted herein may also be covered by one or more United States, international or foreign trademarks.

This document is written in English but may be translated into multiple languages for reference. Only the English version of this document is the final and determinative format released by Diodes Incorporated.

**LIFE SUPPORT**

Diodes Incorporated products are specifically not authorized for use as critical components in life support devices or systems without the express written approval of the Chief Executive Officer of Diodes Incorporated. As used herein:

A. Life support devices or systems are devices or systems which:

1. are intended to implant into the body, or
2. support or sustain life and whose failure to perform when properly used in accordance with instructions for use provided in the labeling can be reasonably expected to result in significant injury to the user.

B. A critical component is any component in a life support device or system whose failure to perform can be reasonably expected to cause the failure of the life support device or to affect its safety or effectiveness.

Customers represent that they have all necessary expertise in the safety and regulatory ramifications of their life support devices or systems, and acknowledge and agree that they are solely responsible for all legal, regulatory and safety-related requirements concerning their products and any use of Diodes Incorporated products in such safety-critical, life support devices or systems, notwithstanding any devices- or systems-related information or support that may be provided by Diodes Incorporated. Further, Customers must fully indemnify Diodes Incorporated and its representatives against any damages arising out of the use of Diodes Incorporated products in such safety-critical, life support devices or systems.

Copyright © 2014, Diodes Incorporated

**www.diodes.com**