

To our customers,

Old Company Name in Catalogs and Other Documents

On April 1st, 2010, NEC Electronics Corporation merged with Renesas Technology Corporation, and Renesas Electronics Corporation took over all the business of both companies. Therefore, although the old company name remains in this document, it is a valid Renesas Electronics document. We appreciate your understanding.

Renesas Electronics website: <http://www.renesas.com>

April 1st, 2010
Renesas Electronics Corporation

Issued by: Renesas Electronics Corporation (<http://www.renesas.com>)

Send any inquiries to <http://www.renesas.com/inquiry>.

Notice

1. All information included in this document is current as of the date this document is issued. Such information, however, is subject to change without any prior notice. Before purchasing or using any Renesas Electronics products listed herein, please confirm the latest product information with a Renesas Electronics sales office. Also, please pay regular and careful attention to additional and different information to be disclosed by Renesas Electronics such as that disclosed through our website.
2. Renesas Electronics does not assume any liability for infringement of patents, copyrights, or other intellectual property rights of third parties by or arising from the use of Renesas Electronics products or technical information described in this document. No license, express, implied or otherwise, is granted hereby under any patents, copyrights or other intellectual property rights of Renesas Electronics or others.
3. You should not alter, modify, copy, or otherwise misappropriate any Renesas Electronics product, whether in whole or in part.
4. Descriptions of circuits, software and other related information in this document are provided only to illustrate the operation of semiconductor products and application examples. You are fully responsible for the incorporation of these circuits, software, and information in the design of your equipment. Renesas Electronics assumes no responsibility for any losses incurred by you or third parties arising from the use of these circuits, software, or information.
5. When exporting the products or technology described in this document, you should comply with the applicable export control laws and regulations and follow the procedures required by such laws and regulations. You should not use Renesas Electronics products or the technology described in this document for any purpose relating to military applications or use by the military, including but not limited to the development of weapons of mass destruction. Renesas Electronics products and technology may not be used for or incorporated into any products or systems whose manufacture, use, or sale is prohibited under any applicable domestic or foreign laws or regulations.
6. Renesas Electronics has used reasonable care in preparing the information included in this document, but Renesas Electronics does not warrant that such information is error free. Renesas Electronics assumes no liability whatsoever for any damages incurred by you resulting from errors in or omissions from the information included herein.
7. Renesas Electronics products are classified according to the following three quality grades: “Standard”, “High Quality”, and “Specific”. The recommended applications for each Renesas Electronics product depends on the product’s quality grade, as indicated below. You must check the quality grade of each Renesas Electronics product before using it in a particular application. You may not use any Renesas Electronics product for any application categorized as “Specific” without the prior written consent of Renesas Electronics. Further, you may not use any Renesas Electronics product for any application for which it is not intended without the prior written consent of Renesas Electronics. Renesas Electronics shall not be in any way liable for any damages or losses incurred by you or third parties arising from the use of any Renesas Electronics product for an application categorized as “Specific” or for which the product is not intended where you have failed to obtain the prior written consent of Renesas Electronics. The quality grade of each Renesas Electronics product is “Standard” unless otherwise expressly specified in a Renesas Electronics data sheets or data books, etc.
 - “Standard”: Computers; office equipment; communications equipment; test and measurement equipment; audio and visual equipment; home electronic appliances; machine tools; personal electronic equipment; and industrial robots.
 - “High Quality”: Transportation equipment (automobiles, trains, ships, etc.); traffic control systems; anti-disaster systems; anti-crime systems; safety equipment; and medical equipment not specifically designed for life support.
 - “Specific”: Aircraft; aerospace equipment; submersible repeaters; nuclear reactor control systems; medical equipment or systems for life support (e.g. artificial life support devices or systems), surgical implantations, or healthcare intervention (e.g. excision, etc.), and any other applications or purposes that pose a direct threat to human life.
8. You should use the Renesas Electronics products described in this document within the range specified by Renesas Electronics, especially with respect to the maximum rating, operating supply voltage range, movement power voltage range, heat radiation characteristics, installation and other product characteristics. Renesas Electronics shall have no liability for malfunctions or damages arising out of the use of Renesas Electronics products beyond such specified ranges.
9. Although Renesas Electronics endeavors to improve the quality and reliability of its products, semiconductor products have specific characteristics such as the occurrence of failure at a certain rate and malfunctions under certain use conditions. Further, Renesas Electronics products are not subject to radiation resistance design. Please be sure to implement safety measures to guard them against the possibility of physical injury, and injury or damage caused by fire in the event of the failure of a Renesas Electronics product, such as safety design for hardware and software including but not limited to redundancy, fire control and malfunction prevention, appropriate treatment for aging degradation or any other appropriate measures. Because the evaluation of microcomputer software alone is very difficult, please evaluate the safety of the final products or system manufactured by you.
10. Please contact a Renesas Electronics sales office for details as to environmental matters such as the environmental compatibility of each Renesas Electronics product. Please use Renesas Electronics products in compliance with all applicable laws and regulations that regulate the inclusion or use of controlled substances, including without limitation, the EU RoHS Directive. Renesas Electronics assumes no liability for damages or losses occurring as a result of your noncompliance with applicable laws and regulations.
11. This document may not be reproduced or duplicated, in any form, in whole or in part, without prior written consent of Renesas Electronics.
12. Please contact a Renesas Electronics sales office if you have any questions regarding the information contained in this document or Renesas Electronics products, or if you have any other inquiries.

(Note 1) “Renesas Electronics” as used in this document means Renesas Electronics Corporation and also includes its majority-owned subsidiaries.

(Note 2) “Renesas Electronics product(s)” means any product developed or manufactured by or for Renesas Electronics.

DATA SHEET



BIPOLAR ANALOG INTEGRATED CIRCUIT

μ PC451GR-9LG, μ PC324GR-9LG

SINGLE POWER SUPPLY QUAD OPERATIONAL AMPLIFIERS

<R> DESCRIPTION

The μ PC451GR-9LG, μ PC324GR-9LG are quad operational amplifiers which are designed to operate for a single power supply. It includes features of low-voltage operation, a common-mode input voltage that range from V^- (GND) level, an output from a V^- (GND) level that is determined by the output stage of class C push-pull circuit and a 50 μ A(TYP.) constant current, and a low current consumption.

In addition, this can operate at both positive and negative power supply and it can be extensively used in various amplifier circuits.

The μ PC451GR-9LG which expands temperature type is suited for wide operating ambient temperature use, and μ PC324GR-9LG is used for general purposes.

A DC parameter selection that is compatible to operational amplifiers is also available.

μ PC1251GR-9LG, μ PC1251MP-KAA, μ PC358GR-9LG which are dual types with the same circuit configuration are also available as series of operational amplifiers.

<R> FEATURES

- Input Offset Voltage ± 2 mV (TYP.)
- Input Offset Current ± 5 nA (TYP.)
- Large Signal Voltage Gain 100000 (TYP.)
- Small Package (The mounting area is reduced to half compared to the conventional 14-pin plastic SOP (1.27 mm pitch))
- Internal frequency compensation
- Output short-circuit protection

<R> ORDERING INFORMATION

Part Number	Selected Grade	Package	Package Type
μ PC451GR-9LG-E1-A ^{Note}	Standard	14-pin plastic TSSOP (5.72 mm(225))	<ul style="list-style-type: none"> • 16 mm wide embossed taping • Pin 1 on draw-out side
μ PC451GR-9LG-E2-A ^{Note}	Standard	14-pin plastic TSSOP (5.72 mm(225))	<ul style="list-style-type: none"> • 16 mm wide embossed taping • Pin 1 at take-up side
μ PC451GR(5)-9LG-E1-A ^{Note}	DC parameter selection	14-pin plastic TSSOP (5.72 mm(225))	<ul style="list-style-type: none"> • 16 mm wide embossed taping • Pin 1 on draw-out side
μ PC451GR(5)-9LG-E2-A ^{Note}	DC parameter selection	14-pin plastic TSSOP (5.72 mm(225))	<ul style="list-style-type: none"> • 16 mm wide embossed taping • Pin 1 at take-up side
μ PC324GR-9LG-E1-A ^{Note}	Standard	14-pin plastic TSSOP(5.72 mm(225))	<ul style="list-style-type: none"> • 16 mm wide embossed taping • Pin 1 on draw-out side
μ PC324GR-9LG-E2-A ^{Note}	Standard	14-pin plastic TSSOP(5.72 mm(225))	<ul style="list-style-type: none"> • 16 mm wide embossed taping • Pin 1 at take-up side
μ PC324GR(5)-9LG-E1-A ^{Note}	DC parameter selection	14-pin plastic TSSOP(5.72 mm(225))	<ul style="list-style-type: none"> • 16 mm wide embossed taping • Pin 1 on draw-out side
μ PC324GR(5)-9LG-E2-A ^{Note}	DC parameter selection	14-pin plastic TSSOP(5.72 mm(225))	<ul style="list-style-type: none"> • 16 mm wide embossed taping • Pin 1 at take-up side

Note Pb-free (This product does not contain Pb in the external electrode and other parts.)

The information in this document is subject to change without notice. Before using this document, please confirm that this is the latest version.

Not all products and/or types are available in every country. Please check with an NEC Electronics sales representative for availability and additional information.

EQUIVALENT CIRCUIT (1/4 Circuit)

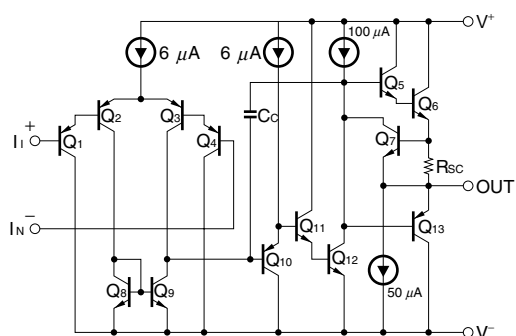

<R> PIN CONFIGURATION (Marking side)

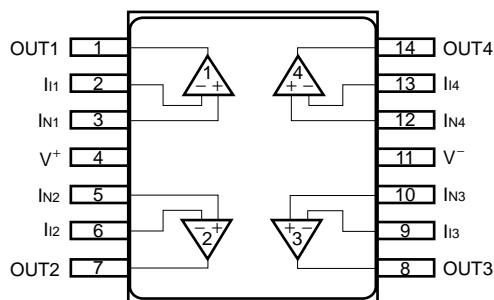

<R> ABSOLUTE MAXIMUM RATINGS (TA = 25°C)

Parameter	Symbol	μPC451GR-9LG, μPC451GR(5)-9LG	μPC324GR-9LG, μPC324GR(5)-9LG	Unit
Voltage between V ⁺ and V ⁻ ^{Note1}	V ⁺ - V ⁻	-0.3 to +32		V
Differential Input Voltage	V _{ID}	±32		V
Input Voltage ^{Note2}	V _I	V ⁻ - 0.3 to V ⁻ + 32		V
Output applied Voltage ^{Note3}	V _O	V ⁻ - 0.3 to V ⁺ + 0.3		V
Total Power Dissipation ^{Note4}	P _T	550		mW
Output Short Circuit Duration ^{Note5}	t _s	Indefinite		s
Operating Ambient Temperature	T _A	-40 to +125	-40 to +85	°C
Storage Temperature	T _{stg}	-55 to +150	-55 to +125	°C

Note1. Note that reverse connections of the power supply may damage ICs.

2. The input voltage is allowed to input without damage or destruction independent of the magnitude of V⁺. Either input signal is not allowed to go negative by more than 0.3 V. In addition, the input voltage that operates normally as an operational amplifier is within the Common Mode Input Voltage range of an electrical characteristic.
3. A range where input voltage can be applied to an output pin externally with no deterioration or damage to the feature (characteristic). The input voltage can be applied regardless of the electric supply voltage. This specification which includes the transition state such as electric power ON/OFF must be kept.
4. This is the value of when the glass epoxy substrate (size: 100 mm x 100 mm, thickness: 1 mm, 15% of the substrate area where only one side is copper foiled is filling wired) is mounted.

Note that restrictions will be made to the following conditions for each product, and the derating ratio depending on the operating ambient temperature.

μPC451GR-9LG: Derate at -7.0 mW/°C when T_A > 71°C.

(Junction - ambient thermal resistance R_{th(J-A)} = 144°C/W)

μPC324GR-9LG: Derate at -7.0 mW/°C when T_A > 46°C.

(Junction - ambient thermal resistance R_{th(J-A)} = 144°C/W)

5. V⁺ ≤ +15 V, 1 arbitrary channel only. Pay careful attention to the total power dissipation not to exceed the absolute maximum ratings, **Note 4**.

RECOMMENDED OPERATING CONDITIONS

Parameter	Symbol	MIN.	TYP.	MAX.	Unit
Power Supply Voltage (Split)	V^{\pm}	± 1.5		± 15	V
Power Supply Voltage ($V^- = \text{GND}$)	V^+	+3		+30	V

<R> **ELECTRICAL CHARACTERISTICS**

μ PC451GR-9LG, μ PC324GR-9LG ($T_A = 25^{\circ}\text{C}$, $V^+ = +5\text{ V}$, $V^- = \text{GND}$)

Parameter	Symbol	Conditions	MIN.	TYP.	MAX.	Unit
Input Offset Voltage	V_{IO}	$R_S = 0\ \Omega$		± 2	± 7	mV
Input Offset Current	I_{IO}			± 5	± 50	nA
Input Bias Current ^{Note1}	I_B			15	250	nA
Large Signal Voltage Gain	A_V	$R_L \geq 2\ \text{k}\Omega$	25000	100000		
Circuit Current ^{Note2}	I_{CC}	$R_L = \infty$, $I_O = 0\ \text{A}$		1.2	2.0	mA
Common Mode Rejection Ratio	CMR		65	85		dB
Supply Voltage Rejection Ratio	SVR		65	100		dB
Output Voltage Swing	V_O	$R_L = 2\ \text{k}\Omega$ (Connect to GND)	0		$V^+ - 1.5$	V
Common Mode Input Voltage Range	V_{ICM}		0		$V^+ - 1.5$	V
Output Source Current	$I_{O\ \text{SOURCE}}$	$V_{IN(+)} = +1\ \text{V}$, $V_{IN(-)} = 0\ \text{V}$	20	40		mA
Output Sink Current	$I_{O\ \text{SINK1}}$	$V_{IN(-)} = +1\ \text{V}$, $V_{IN(+)} = 0\ \text{V}$	10	20		mA
	$I_{O\ \text{SINK2}}$	$V_{IN(-)} = +1\ \text{V}$, $V_{IN(+)} = 0\ \text{V}$, $V_O = 200\ \text{mV}$	12	50		μA
Channel Separation		$f = 1\ \text{to}\ 20\ \text{kHz}$		120		dB

μ PC451GR(5)-9LG, μ PC324GR(5)-9LG ($T_A = 25^{\circ}\text{C}$, $V^+ = +5\ \text{V}$, $V^- = \text{GND}$)

Parameter	Symbol	Conditions	MIN.	TYP.	MAX.	Unit
Input Offset Voltage	V_{IO}	$R_S = 0\ \Omega$		± 2	± 3	mV
Input Offset Current	I_{IO}			± 5	± 50	nA
Input Bias Current ^{Note1}	I_B			15	60	nA
Large Signal Voltage Gain	A_V	$R_L \geq 2\ \text{k}\Omega$	50000	100000		
Circuit Current ^{Note2}	I_{CC}	$R_L = \infty$, $I_O = 0\ \text{A}$		1.2	1.5	mA
Common Mode Rejection Ratio	CMR		65	85		dB
Supply Voltage Rejection Ratio	SVR		65	100		dB
Output Voltage Swing	V_O	$R_L = 2\ \text{k}\Omega$ (Connect to GND)	0		$V^+ - 1.5$	V
Common Mode Input Voltage Range	V_{ICM}		0		$V^+ - 1.4$	V
Output Source Current	$I_{O\ \text{SOURCE}}$	$V_{IN(+)} = +1\ \text{V}$, $V_{IN(-)} = 0\ \text{V}$	30	40		mA
Output Sink Current	$I_{O\ \text{SINK1}}$	$V_{IN(-)} = +1\ \text{V}$, $V_{IN(+)} = 0\ \text{V}$	15	20		mA
	$I_{O\ \text{SINK2}}$	$V_{IN(-)} = +1\ \text{V}$, $V_{IN(+)} = 0\ \text{V}$, $V_O = 200\ \text{mV}$	30	50	70	μA
Channel Separation		$f = 1\ \text{to}\ 20\ \text{kHz}$		120		dB

Notes1. The input bias current flows in the direction where the IC flows out because the first stage is configured with a PNP transistor.

2. This is a current that flows in the internal circuit. This current will flow irrespective of the channel used.

<R> TYPICAL PERFORMANCE CHARACTERISTICS ($T_A = 25^\circ\text{C}$, TYP.) (Reference value)

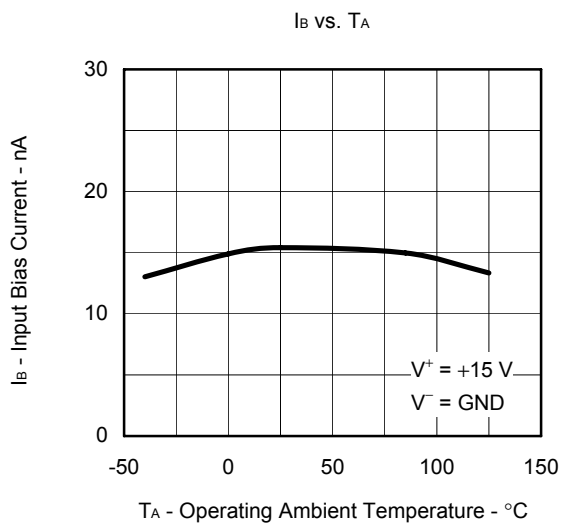
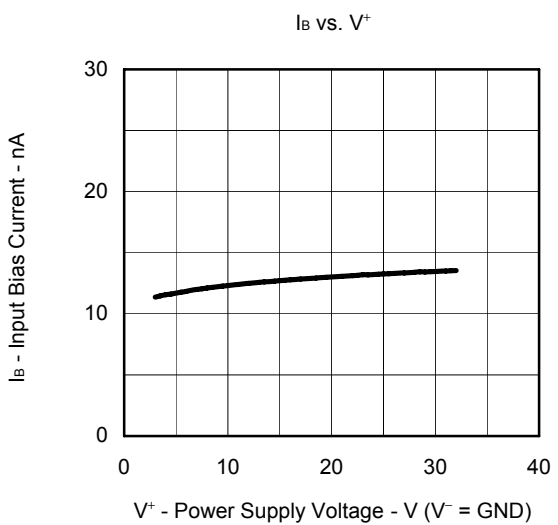
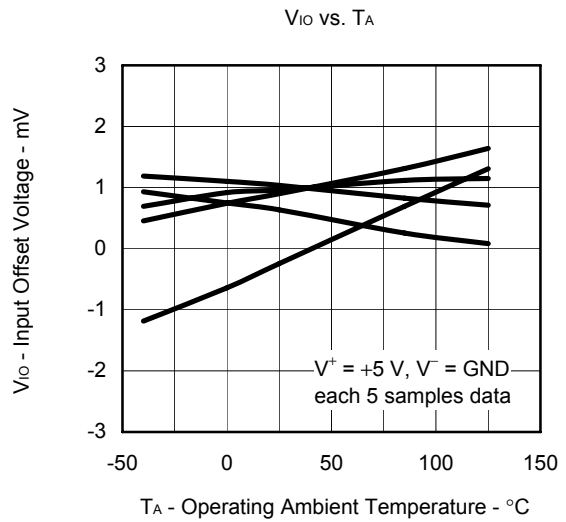
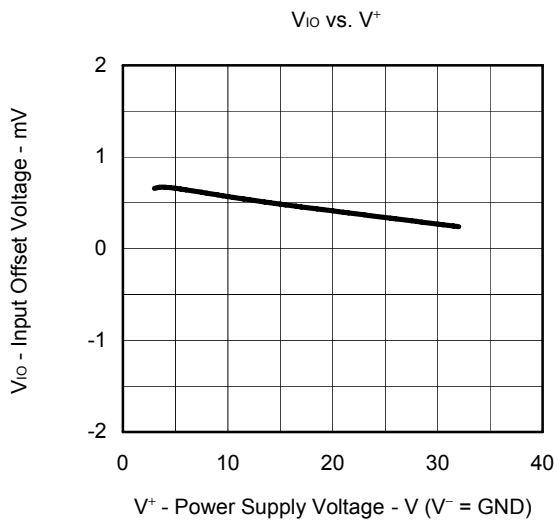
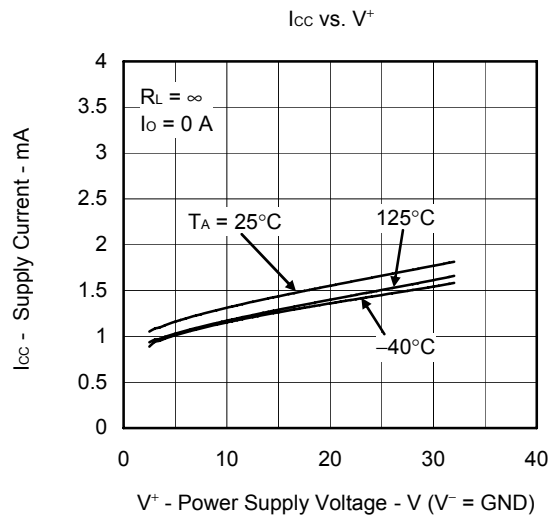
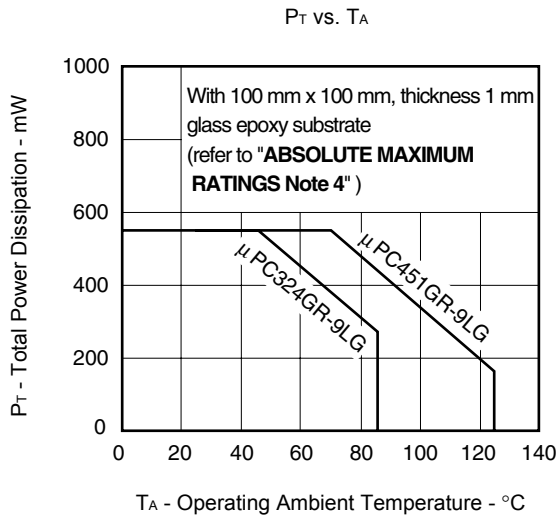

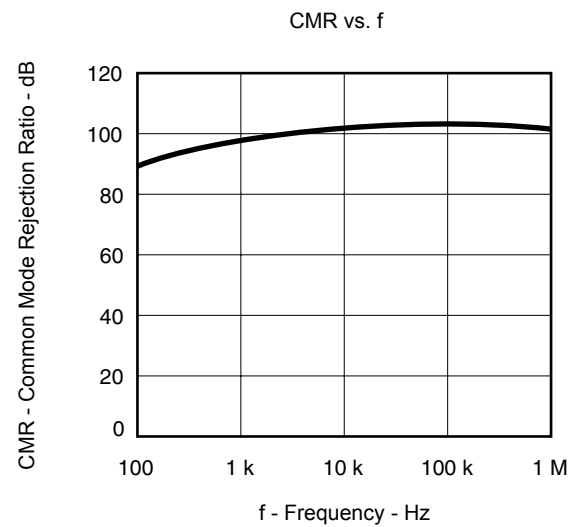
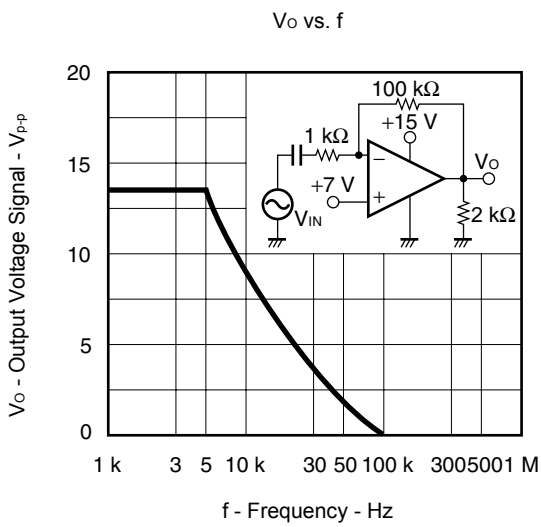
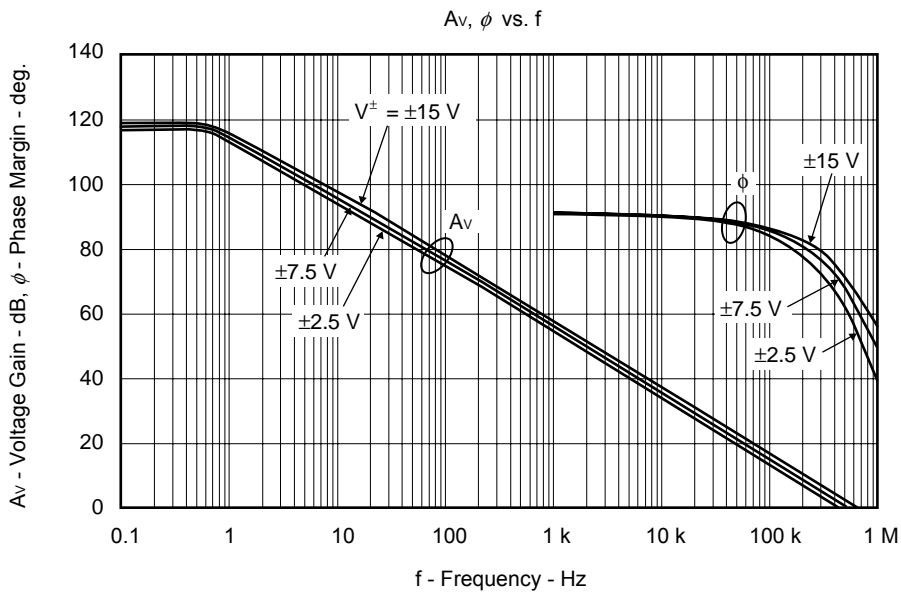
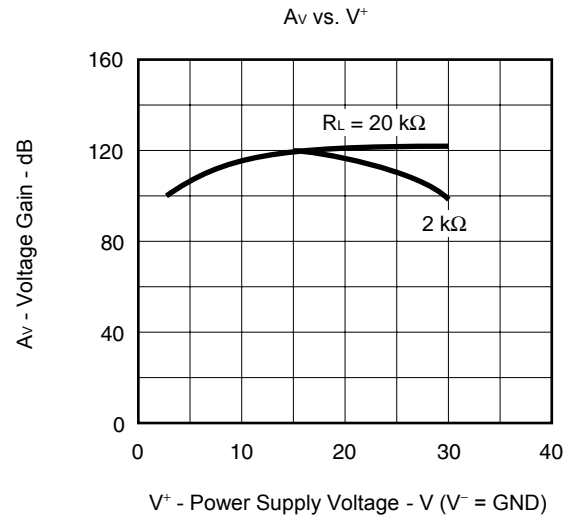
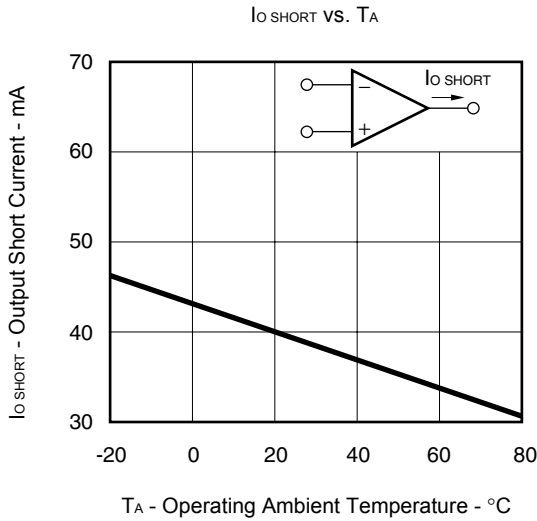

PULSE RESPONSE

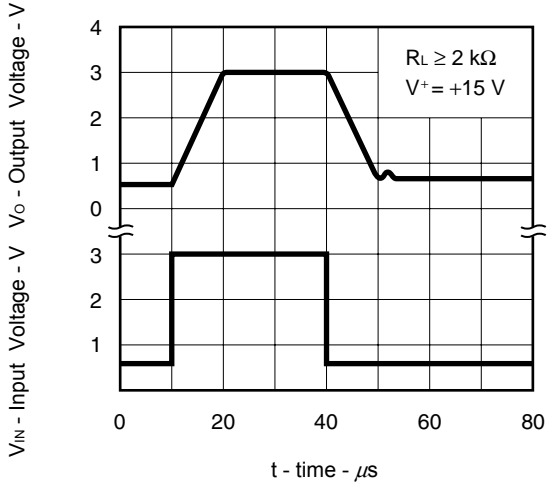

SR - T_A

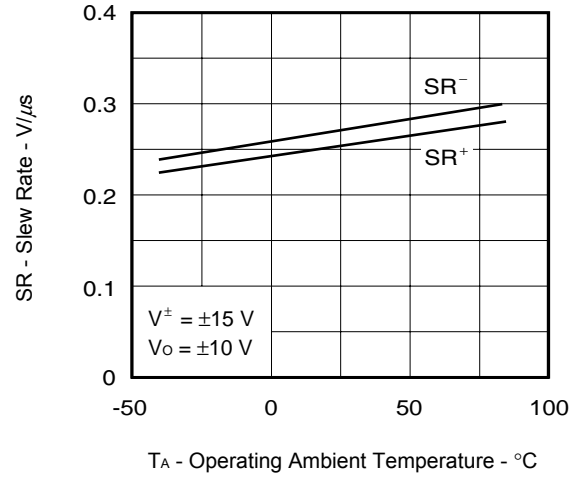

V_O vs. I_O SINK

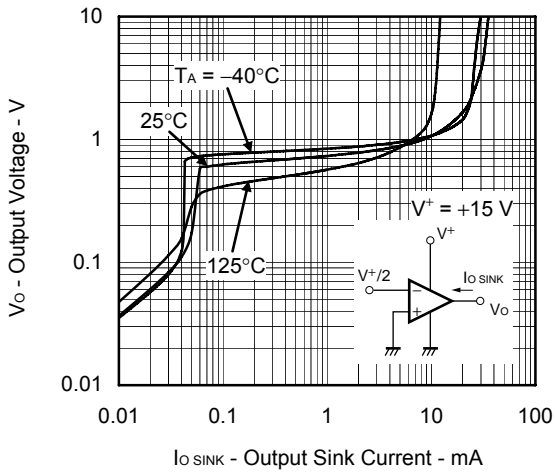

ΔV_O vs. I_O SOURCE

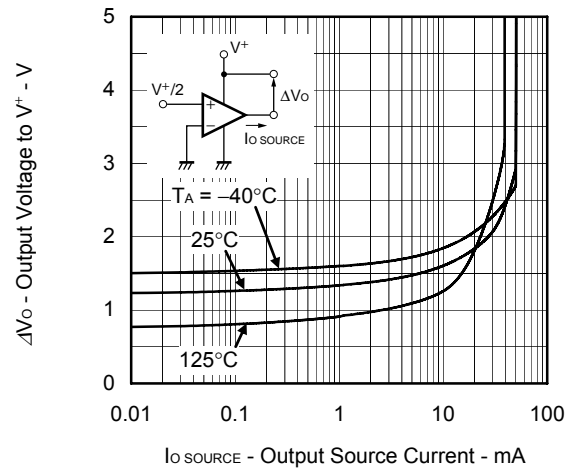

<R> PRECAUTIONS FOR USE

O The process of unused circuits

If there is an unused circuit, the following connection is recommended.

Process example of unused circuits

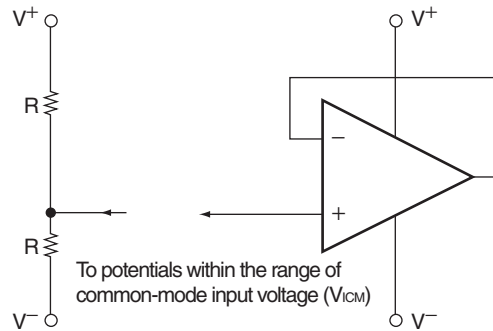

Remark A midpoint potential of V^+ and V^- is applied to this example.

O Ratings of input/output pin voltage

When the voltage of input/output pin exceeds the absolute maximum rating, it may cause degradation of characteristics or damages, by a conduction of a parasitic diode within an IC. In addition, when the input pin may be lower than V^- , or the output pin may exceed the power supply voltage, it is recommended to make a clamp circuit by a diode whose forward voltage is low (e.g.: Schottky diode) for protection.

O Range of common-mode input voltage

When the supply voltage does not meet the condition of electrical characteristics, the range of common-mode input voltage is as follows.

V_{ICM} (TYP.): V^- to $V^+ - 1.5$ (V) ($T_A = 25^\circ\text{C}$)

During designing, temperature characteristics for use with allowance.

O The maximum output voltage

The range of the TYP. value of the maximum output voltage when the supply voltage does not meet the condition of electrical characteristics is as follows:

V_{Om^+} (TYP.): $V^+ - 1.5$ (V) ($T_A = 25^\circ\text{C}$), V_{Om^-} (TYP.) ($I_{o\ SINK} \leq 50\ \mu\text{A}$): Approx. V^- (V) ($T_A = 25^\circ\text{C}$)

During designing, consider variations in characteristics and temperature characteristics for use with allowance.

In addition, also note that the output voltage range ($V_{Om^+} - V_{Om^-}$) becomes narrow when an output current increases.

O Operation of output

This IC consist an output level of a class C push-pull. Therefore, when a load resistance is connected to the midpoint potential of V^+ , V^- , a crossover distortion occurs at the transition state of output current flow direction (source, sink).

O Handling of ICs

When stress is added to ICs due to warpage or bending of a board, the characteristic fluctuates due to piezoelectric effect. Therefore, pay attention to warpage or bending of a board.

PACKAGE DRAWINGS (Unit: mm)

14-PIN PLASTIC TSSOP (5.72mm (225))

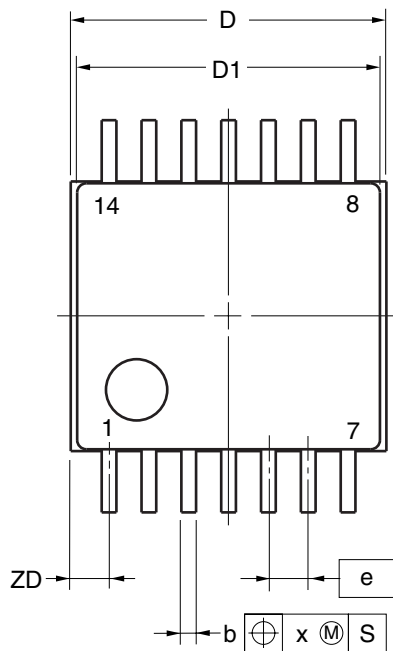

detail of lead end

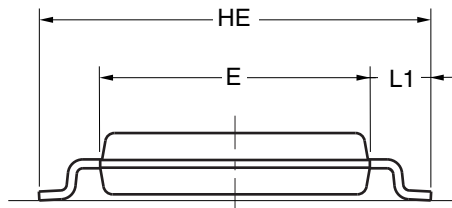
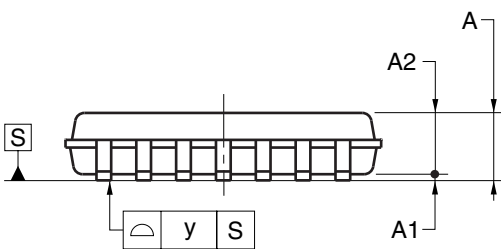
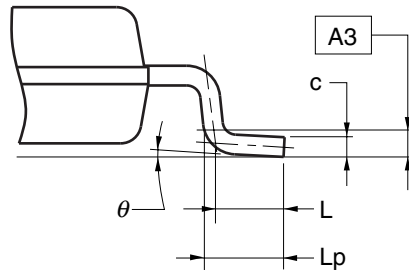

(UNIT:mm)

ITEM	DIMENSIONS
D	5.15±0.15
D1	5.00±0.10
E	4.40±0.10
HE	6.40±0.20
A	1.20 MAX.
A1	0.10±0.05
A2	1.00±0.05
A3	0.25
b	0.24 ^{+0.06} _{-0.05}
c	0.145±0.055
L	0.50
Lp	0.60±0.15
L1	1.00±0.20
θ	3° ^{+5°} _{-3°}
e	0.65
x	0.10
y	0.10
ZD	0.625

P14GR-65-9LG

NOTE

Each lead centerline is located within 0.10mm of its true position at maximum material condition.

© NEC Electronics Corporation 2005

<R> **RECOMMENDED SOLDERING CONDITIONS**

The μPC451GR-9LG, μPC324GR-9LG should be soldered and mounted under the following recommended conditions.

For soldering methods and conditions other than those recommended below, contact an NEC Electronics sales representative.

For technical information, see the following website.

Semiconductor Device Mount Manual (<http://www.necel.com/pkg/en/mount/index.html>)

Type of Surface Mount Device

μPC451GR-9LG-A^{Note}, μPC451GR(5)-9LG-A^{Note},
 μPC324GR-9LG-A^{Note}, μPC324GR(5)-9LG-A^{Note}: 14-pin plastic TSSOP (5.72 mm (225))

Process	Conditions	Symbol
Infrared ray reflow	Peak temperature: 260°C, Reflow time: 60 seconds or less (at 220°C or higher), Maximum number of reflow processes: 3 times.	IR60-00-3
Wave soldering	Solder temperature: 260°C or below, Flow time: 10 seconds or less, Maximum number of flow processes: 1 time, Pre-heating temperature: 120°C or below (Package surface temperature).	WS60-00-1
Partial heating method	Pin temperature: 350°C or below, Heat time: 3 seconds or less (Per each side of the device).	P350

Note Pb-free (This product does not contain Pb in external electrode and other parts.)

Caution Apply only one kind of soldering condition to a device, except for “partial heating method”, or the device will be damaged by heat stress.

Remark Flux: Rosin flux with low chlorine (0.2 Wt% or below) recommended.

<R> **REFERENCE DOCUMENTS**

Document Name	Document No.
QUALITY GRADES ON NEC SEMICONDUCTOR DEVICES	C11531E
SEMICONDUCTOR DEVICE MOUNT MANUAL	http://www.necel.com/pkg/en/mount/index.html
NEC SEMICONDUCTOR DEVICE RELIABILITY/QUALITY CONTROL SYSTEM-STANDARD LINEAR IC	IEI-1212
REVIEW OF QUALITY AND RELIABILITY HANDBOOK	C12769E
NEC SEMICONDUCTOR DEVICE RELIABILITY/QUALITY CONTROL SYSTEM	C10983E

- **The information in this document is current as of December, 2007. The information is subject to change without notice. For actual design-in, refer to the latest publications of NEC Electronics data sheets or data books, etc., for the most up-to-date specifications of NEC Electronics products. Not all products and/or types are available in every country. Please check with an NEC Electronics sales representative for availability and additional information.**
- No part of this document may be copied or reproduced in any form or by any means without the prior written consent of NEC Electronics. NEC Electronics assumes no responsibility for any errors that may appear in this document.
- NEC Electronics does not assume any liability for infringement of patents, copyrights or other intellectual property rights of third parties by or arising from the use of NEC Electronics products listed in this document or any other liability arising from the use of such products. No license, express, implied or otherwise, is granted under any patents, copyrights or other intellectual property rights of NEC Electronics or others.
- Descriptions of circuits, software and other related information in this document are provided for illustrative purposes in semiconductor product operation and application examples. The incorporation of these circuits, software and information in the design of a customer's equipment shall be done under the full responsibility of the customer. NEC Electronics assumes no responsibility for any losses incurred by customers or third parties arising from the use of these circuits, software and information.
- While NEC Electronics endeavors to enhance the quality, reliability and safety of NEC Electronics products, customers agree and acknowledge that the possibility of defects thereof cannot be eliminated entirely. To minimize risks of damage to property or injury (including death) to persons arising from defects in NEC Electronics products, customers must incorporate sufficient safety measures in their design, such as redundancy, fire-containment and anti-failure features.
- NEC Electronics products are classified into the following three quality grades: "Standard", "Special" and "Specific".

The "Specific" quality grade applies only to NEC Electronics products developed based on a customer-designated "quality assurance program" for a specific application. The recommended applications of an NEC Electronics product depend on its quality grade, as indicated below. Customers must check the quality grade of each NEC Electronics product before using it in a particular application.

"Standard": Computers, office equipment, communications equipment, test and measurement equipment, audio and visual equipment, home electronic appliances, machine tools, personal electronic equipment and industrial robots.

"Special": Transportation equipment (automobiles, trains, ships, etc.), traffic control systems, anti-disaster systems, anti-crime systems, safety equipment and medical equipment (not specifically designed for life support).

"Specific": Aircraft, aerospace equipment, submersible repeaters, nuclear reactor control systems, life support systems and medical equipment for life support, etc.

The quality grade of NEC Electronics products is "Standard" unless otherwise expressly specified in NEC Electronics data sheets or data books, etc. If customers wish to use NEC Electronics products in applications not intended by NEC Electronics, they must contact an NEC Electronics sales representative in advance to determine NEC Electronics' willingness to support a given application.

(Note)

- (1) "NEC Electronics" as used in this statement means NEC Electronics Corporation and also includes its majority-owned subsidiaries.
- (2) "NEC Electronics products" means any product developed or manufactured by or for NEC Electronics (as defined above).