

# SK5817WA-SK5819WA

## SCHOTTKY BARRIER RECTIFIERS

### • Features

- Metal silicon junction, majority carrier conduction
- Guarding for overvoltage protection
- Low power loss, high efficiency
- High current capability
- low forward voltage drop
- High surge capability
- For use in low voltage, high frequency inverters, free wheeling, and polarity protection applications

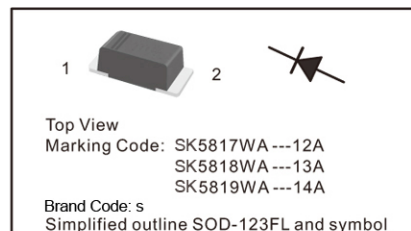

### • Maximum Ratings and Electrical characteristics

Ratings at 25 °C ambient temperature unless otherwise specified.

Parameter	Symbols	SK5817WA	SK5818WA	SK5819WA	Units
Maximum Repetitive Peak Reverse Voltage	$V_{RRM}$	20	30	40	V
Maximum RMS voltage	$V_{RMS}$	14	21	28	V
Maximum DC Blocking Voltage	$V_{DC}$	20	30	40	V
Maximum Average Forward Rectified Current 0.375" (9.5 mm) Lead Length at $T_L = 90^\circ\text{C}$	$I_{F(AV)}$	1			A
Peak Forward Surge Current, 8.3ms Single Half Sine-wave Superimposed On Rated Load (JEDEC method) at $T_L = 70^\circ\text{C}$	$I_{FSM}$	25			A
Maximum Instantaneous Forward Voltage at 1 A Maximum Instantaneous Forward Voltage at 3.1 A	$V_F$	0.45 0.75	0.55 0.875	0.6 0.9	V
Maximum Instantaneous Reverse Current at $T_A = 25^\circ\text{C}$ Rated DC Reverse Voltage $T_A = 100^\circ\text{C}$	$I_R$	1 10			mA
Typical Thermal Resistance	$R_{\theta JA}$ $R_{\theta JL}$	50 15			$^\circ\text{C/W}$
Typical Junction Capacitance	$C_j$	110			pF
Storage and Operating Junction Temperature Range	$T_j, T_{stg}$	-55 ~ +125			$^\circ\text{C}$

# SK5817WA-SK5819WA

Fig.1 Forward Current Derating Curve

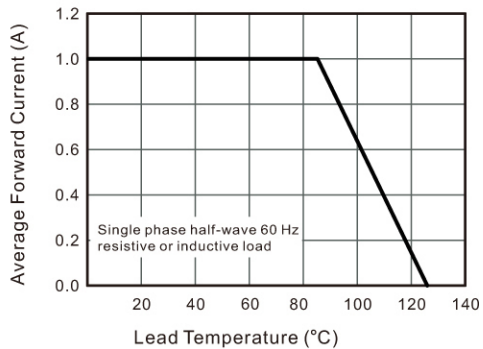

Fig.2 Typical Reverse Characteristics

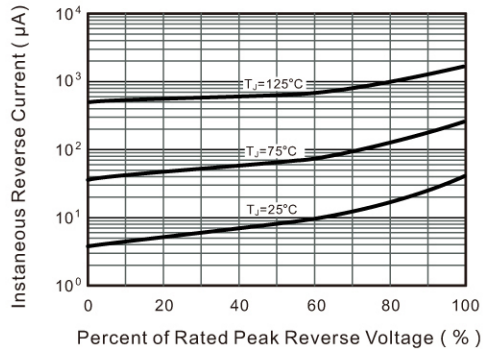

Fig.3 Typical Forward Characteristic

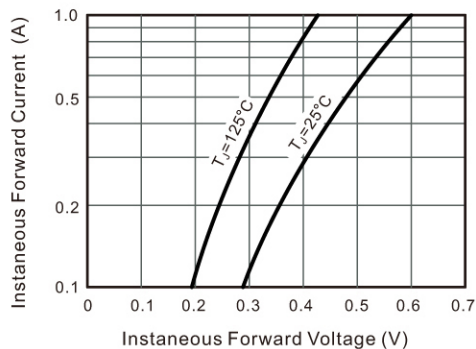

Fig.4 Typical Junction Capacitance

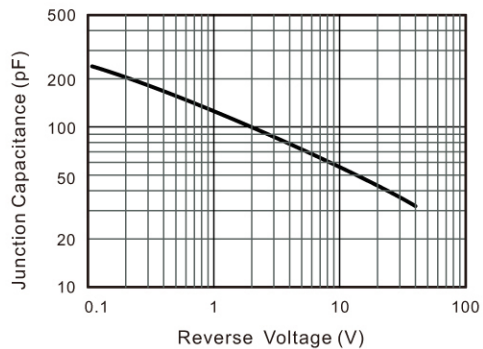

Fig.5 Maximum Non-Repetitive Peak Forward Surge Current

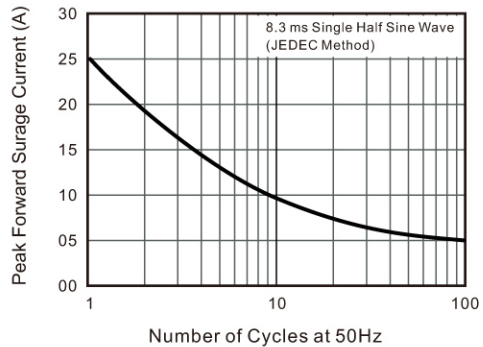
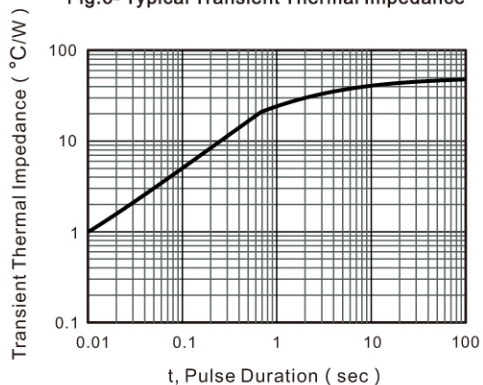

Fig.6- Typical Transient Thermal Impedance



# SK5817WA-SK5819WA

## PACKAGE OUTLINE

Plastic surface mounted package; 2 leads

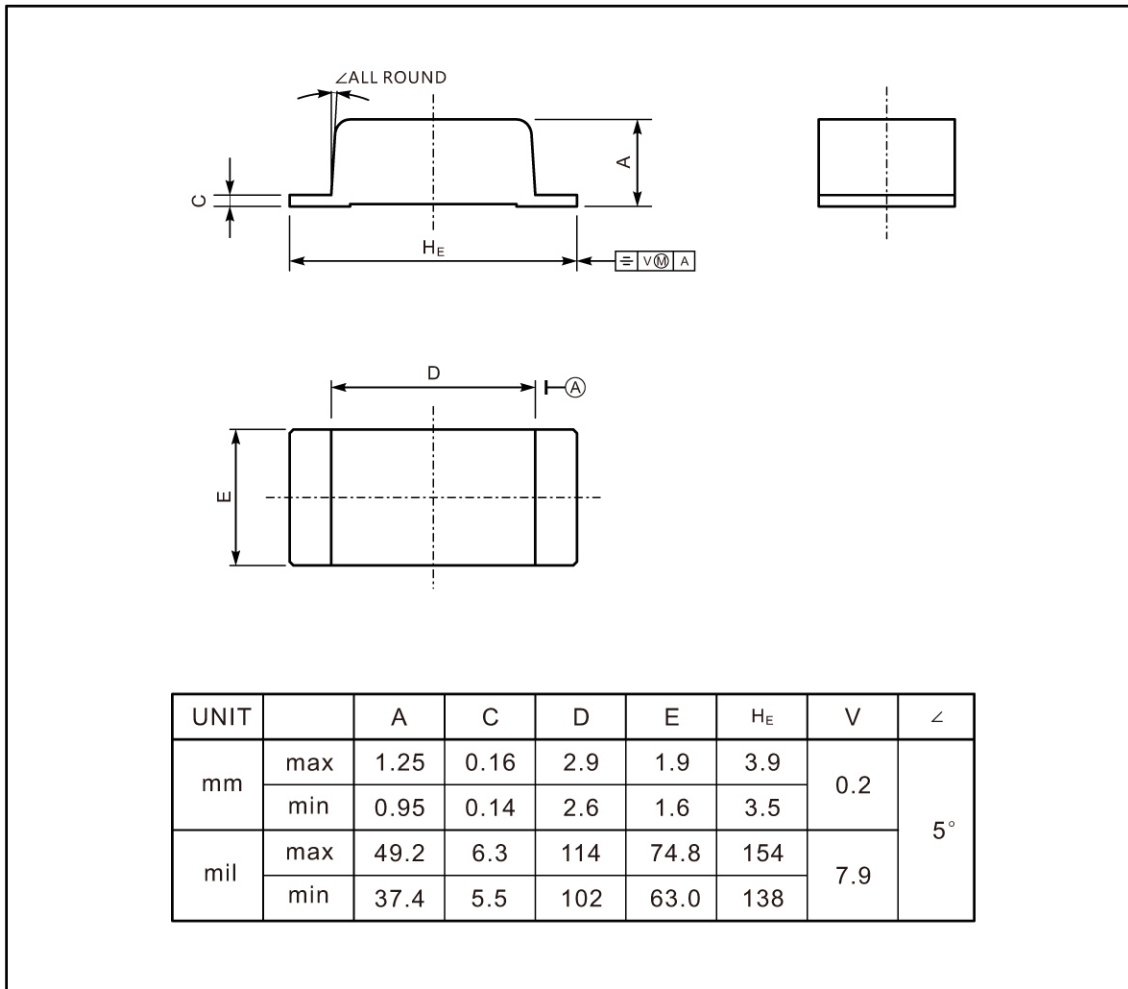

### The recommended mounting pad size

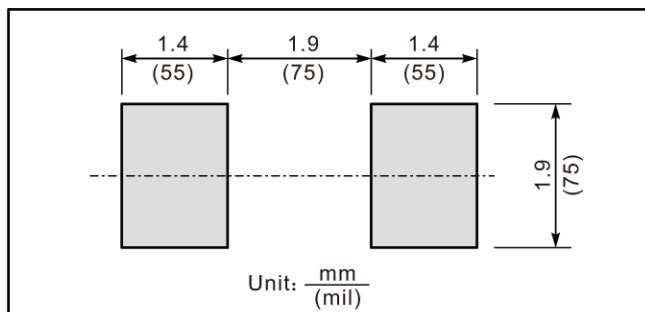

### Marking

Type number	Marking code
SK5817WA	12A
SK5818WA	13A
SK5819WA	14A

# SK5817WA-SK5819WA

• Recommended condition of flow soldering

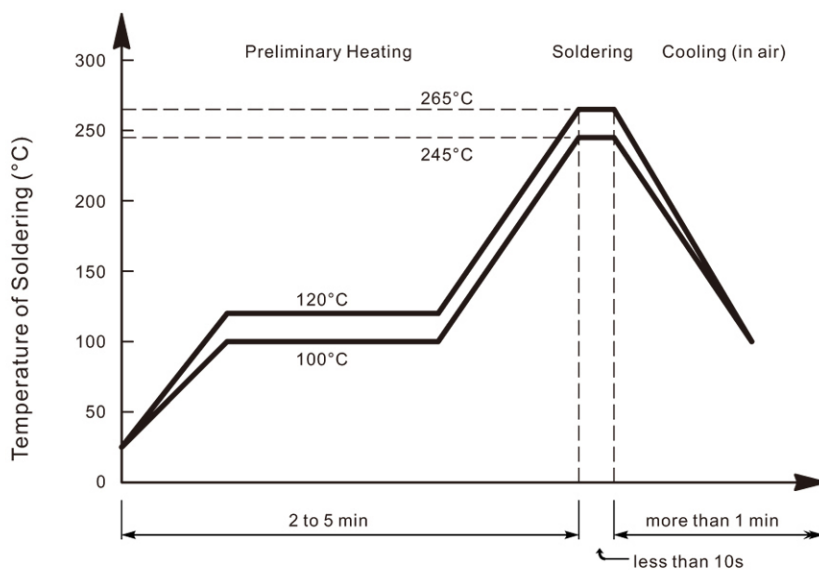

• Recommended condition of reflow soldering

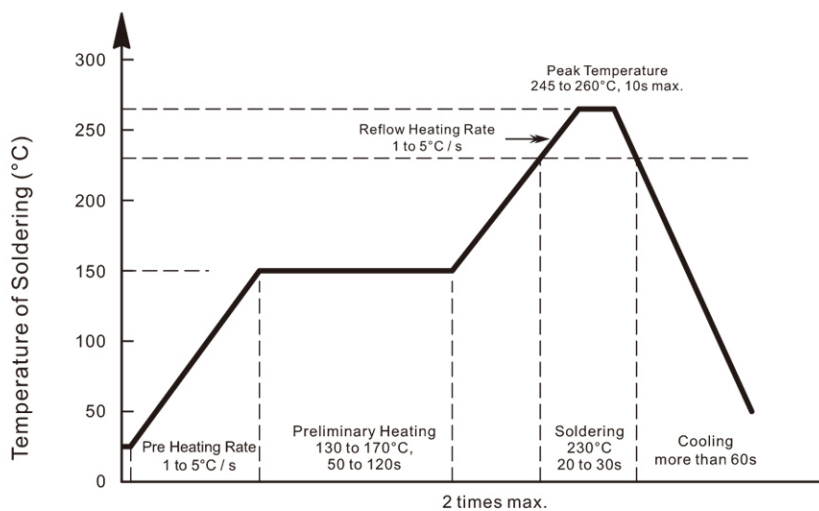

Recommended peak temperature is over 245 °C. If peak temperature is below 245 °C, you may adjust the following parameters; time length of peak temperature (longer), time length of soldering (longer), thickness of solder paste (thicker)

• Condition of hand soldering

Temperature: 370°C  
 Time: 3s max.  
 Times: one time

• Remark:

Lead free solder paste (96.5Sn/3.0Ag/0.5Cu)