

## Axial Lead Transient Voltage Suppressors (TVS)

**P6KE Series 6.8 To 600 V 600W**

### Description

The P6KE series is designed specifically to protect sensitive electronic equipment from voltage transients induced by lightning and other transient voltage events.

### Features

- u Glass passivated chip junction in DO-15 Package
- u Low leakage
- u Uni and Bidirectional unit
- u Excellent clamping capability
- u 600W Peak power capability at 10 × 1000µs waveform Repetition rate (duty cycle):0.01%
- u Fast response time: typically less than 1.0ps from 0 Volts to  $V_{BR}$  min
- u Typical  $I_R$  less than 5µA above 12V.
- u High Temperature soldering: 260°C/40 seconds at terminals
- u Typical maximum temperature coefficient  $\Delta V_{BR} = 0.1\% \times V_{BR}@25^\circ C \times \Delta T$
- u Plastic package has Underwriters Laboratory Flammability 94V-0
- u Matte tin lead-free Plated
- u Halogen free and RoHS compliant
- u Typical failure mode is short from over-specified voltage or current
- u Whisker test is conducted based on JEDEC JESD201A per its table 4a and 4c
- u IEC-61000-4-2 ESD 15kV(Air), 8kV (Contact)
- u ESD protection of data lines in accordance with IEC 61000-4-2 (IEC801-2)
- u EFT protection of data lines in accordance with IEC 61000-4-4 (IEC801-4)

### Applications

TVS devices are ideal for the protection of I/O interfaces,  $V_{CC}$  bus and other vulnerable circuits used in Telecom, Computer, Industrial and Consumer electronic applications.

Uni-directional

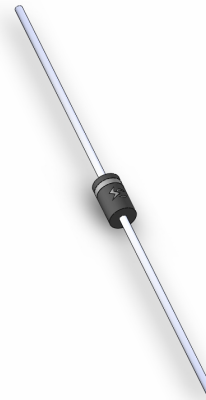

Bi-directional

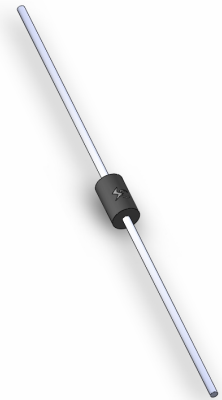

### Functional Diagram

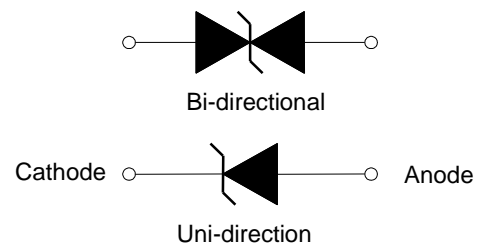

### Agency Approvals

AGENCY	AGENCY FILE NUMBER
	E341027

### Maximum Ratings ( $T_A=25^\circ C$ unless otherwise noted)

Parameter	Symbol	Value	Unit
Peak Pulse Power Dissipation with a 10/1000µs waveform (Fig.1)(Note 1), (Note 2)	$P_{PPM}$	600	Watts
Peak Pulse Current with a 10/1000µs waveform.(Note1, Fig.3)	$I_{PP}$	See Next Table	Amps
Power Dissipation on Infinite Heat Sink at $T_L=75^\circ C$	$P_{M(AV)}$	5.0	Watt
Peak Forward Surge Current, 8.3ms Single Half Sine Wave (Note 3)	$I_{FSM}$	100	Amps
Maximum Instantaneous Forward Voltage at 25A for Unidirectional Only (Note 4)	$V_F$	3.5/5.0	Voltage
Operating junction and Storage Temperature Range.	$T_J, T_{STG}$	-55 to +150	$^\circ C$

### Notes:

1. Non-repetitive current pulse, per Fig. 3 and derated above  $T_A = 25^\circ C$  per Fig. 2.
2. Mounted on 5.0mm x 5.0mm (0.03mm thick) Copper Pads to each terminal.
3. 8.3ms single half sine-wave, or equivalent square wave, Duty cycle = 4 pulses per minutes maximum.
4.  $V_F < 3.5V$  for  $V_{BR} < 200V$  and  $V_F < 6.5V$  for  $V_{BR} > 201V$ .

## Axial Lead Transient Voltage Suppressors (TVS)

**P6KE Series 6.8 To 600 V 600W**
**Electrical Characteristics (T<sub>A</sub>=25°C unless otherwise noted)**

Part Number		Reverse Stand-Off Voltage V <sub>RWM</sub> (V)	Breakdown Voltage V <sub>BR</sub> (V) @I <sub>T</sub>		Test Current I <sub>T</sub> (mA)	Maximum Clamping Voltage V <sub>C</sub> @I <sub>PP</sub> (V)	Maximum Peak Pulse Current I <sub>PP</sub> (A)	Maximum Reverse Leakage I <sub>R</sub> @V <sub>RWM</sub> (μA)
Uni	Bi		MIN	MAX				
P6KE6.8	P6KE6.8C	5.5	6.12	7.48	10	10.8	55.56	1000
P6KE6.8A	P6KE6.8CA	5.8	6.46	7.14	10	10.5	57.14	1000
P6KE7.5	P6KE7.5C	6.1	6.75	8.25	10	11.7	51.28	500
P6KE7.5A	P6KE7.5CA	6.4	7.13	7.88	10	11.3	53.10	500
P6KE8.2	P6KE8.2C	6.6	7.38	9.02	10	12.5	48.00	200
P6KE8.2A	P6KE8.2CA	7.0	7.79	8.61	10	12.1	49.59	200
P6KE9.1	P6KE9.1C	7.4	8.19	10.01	1	13.8	43.48	50
P6KE9.1A	P6KE9.1CA	7.8	8.65	9.56	1	13.4	44.78	50
P6KE10	P6KE10C	8.1	9.00	11.00	1	15.0	40.00	10
P6KE10A	P6KE10CA	8.6	9.50	10.50	1	14.5	41.38	10
P6KE11	P6KE11C	8.9	9.90	12.10	1	16.2	37.04	5
P6KE11A	P6KE11CA	9.4	10.45	11.55	1	15.6	38.46	5
P6KE12	P6KE12C	9.7	10.80	13.20	1	17.3	34.68	5
P6KE12A	P6KE12CA	10.2	11.40	12.60	1	16.7	35.93	5
P6KE13	P6KE13C	10.5	11.70	14.30	1	19.0	31.58	5
P6KE13A	P6KE13CA	11.1	12.35	13.65	1	18.2	32.97	5
P6KE15	P6KE15C	12.1	13.50	16.50	1	22.0	27.27	5
P6KE15A	P6KE15CA	12.8	14.25	15.75	1	21.2	28.30	5
P6KE16	P6KE16C	12.9	14.40	17.60	1	23.5	25.53	5
P6KE16A	P6KE16CA	13.6	15.20	16.80	1	22.5	26.67	5
P6KE18	P6KE18C	14.5	16.20	19.80	1	26.5	22.64	5
P6KE18A	P6KE18CA	15.3	17.10	18.90	1	25.2	23.81	5
P6KE20	P6KE20C	16.2	18.00	22.00	1	29.1	20.62	5
P6KE20A	P6KE20CA	17.1	19.00	21.00	1	27.7	21.66	5
P6KE22	P6KE22C	17.8	19.80	24.20	1	31.9	18.81	5
P6KE22A	P6KE22CA	18.8	20.90	23.10	1	30.6	19.61	5
P6KE24	P6KE24C	19.4	21.60	26.40	1	34.7	17.29	5
P6KE24A	P6KE24CA	20.5	22.80	25.20	1	33.2	18.07	5
P6KE27	P6KE27C	21.8	24.30	29.70	1	39.1	15.35	5
P6KE27A	P6KE27CA	23.1	25.65	28.35	1	37.5	16.00	5
P6KE30	P6KE30C	24.3	27.00	33.00	1	43.5	13.79	5
P6KE30A	P6KE30CA	25.6	28.50	31.50	1	41.4	14.49	5
P6KE33	P6KE33C	26.8	29.70	36.30	1	47.7	12.58	5
P6KE33A	P6KE33CA	28.2	31.35	34.65	1	45.7	13.13	5
P6KE36	P6KE36C	29.1	32.40	39.60	1	52.0	11.54	5
P6KE36A	P6KE36CA	30.8	34.20	37.80	1	49.9	12.02	5
P6KE39	P6KE39C	31.6	35.10	42.90	1	56.4	10.64	5
P6KE39A	P6KE39CA	33.3	37.05	40.95	1	53.9	11.13	5
P6KE43	P6KE43C	34.8	38.70	47.30	1	61.9	9.69	5
P6KE43A	P6KE43CA	36.8	40.85	45.15	1	59.3	10.12	5
P6KE47	P6KE47C	38.1	42.30	51.70	1	67.8	8.85	5
P6KE47A	P6KE47CA	40.2	44.65	49.35	1	64.8	9.26	5
P6KE51	P6KE51C	41.3	45.90	56.10	1	73.5	8.16	5
P6KE51A	P6KE51CA	43.6	48.45	53.55	1	70.1	8.56	5
P6KE56	P6KE56C	45.4	50.40	61.60	1	80.5	7.45	5
P6KE56A	P6KE56CA	47.8	53.20	58.80	1	77.0	7.79	5
P6KE62	P6KE62C	50.2	55.80	68.20	1	89.0	6.74	5
P6KE62A	P6KE62CA	53.0	58.90	65.10	1	85.0	7.06	5
P6KE68	P6KE68C	55.1	61.20	74.80	1	98.0	6.12	5
P6KE68A	P6KE68CA	58.1	64.60	71.40	1	92.0	6.52	5
P6KE75	P6KE75C	60.7	67.50	82.50	1	108.0	5.56	5
P6KE75A	P6KE75CA	64.1	71.25	78.75	1	103.0	5.83	5
P6KE82	P6KE82C	66.4	73.80	90.20	1	118.0	5.08	5
P6KE82A	P6KE82CA	70.1	77.90	86.10	1	113.0	5.31	5

## Axial Lead Transient Voltage Suppressors (TVS)

**P6KE Series 6.8 To 600 V 600W**

**Electrical Characteristics ( $T_A=25^\circ\text{C}$  unless otherwise noted) (Continue)**

Part Number		Reverse Stand-Off Voltage $V_{RWM}$ (V)	Breakdown Voltage $V_{BR}$ (V) @ $I_T$		Test Current $I_T$ (mA)	Maximum Clamping Voltage $V_C$ @ $I_{PP}$ (V)	Maximum Peak Pulse Current $I_{PP}$ (A)	Maximum Reverse Leakage $I_R$ @ $V_{RWM}$ ( $\mu\text{A}$ )
Uni	Bi		MIN	MAX				
P6KE91	P6KE91C	73.7	81.90	100.10	1	131.0	4.58	5
P6KE91A	P6KE91CA	77.8	86.45	95.55	1	125.0	4.80	5
P6KE100	P6KE100C	81.0	90.00	110.00	1	144.0	4.17	5
P6KE100A	P6KE100CA	85.5	95.00	105.00	1	137.0	4.38	5
P6KE110	P6KE110C	89.2	99.00	121.00	1	158.0	3.80	5
P6KE110A	P6KE110CA	94.0	104.50	115.50	1	152.0	3.95	5
P6KE120	P6KE120C	97.2	108.00	132.00	1	173.0	3.47	5
P6KE120A	P6KE120CA	102.0	114.00	126.00	1	165.0	3.64	5
P6KE130	P6KE130C	105.0	117.00	143.00	1	187.0	3.21	5
P6KE130A	P6KE130CA	111.0	123.50	136.50	1	179.0	3.35	5
P6KE150	P6KE150C	121.0	135.00	165.00	1	215.0	2.79	5
P6KE150A	P6KE150CA	128.0	142.50	157.50	1	207.0	2.90	5
P6KE160	P6KE160C	130.0	144.00	176.00	1	230.0	2.61	5
P6KE160A	P6KE160CA	136.0	152.00	168.00	1	219.0	2.74	5
P6KE170	P6KE170C	138.0	153.00	187.00	1	244.0	2.46	5
P6KE170A	P6KE170CA	145.0	161.50	178.50	1	234.0	2.56	5
P6KE180	P6KE180C	146.0	162.00	198.00	1	258.0	2.33	5
P6KE180A	P6KE180CA	154.0	171.00	189.00	1	246.0	2.44	5
P6KE200	P6KE200C	162.0	180.00	220.00	1	287.0	2.09	5
P6KE200A	P6KE200CA	171.0	190.00	210.00	1	274.0	2.19	5
P6KE220	P6KE220C	175.0	198.00	242.00	1	344.0	1.74	5
P6KE220A	P6KE220CA	185.0	209.00	231.00	1	328.0	1.83	5
P6KE250	P6KE250C	202.0	225.00	275.00	1	360.0	1.67	5
P6KE250A	P6KE250CA	214.0	237.50	262.50	1	344.0	1.74	5
P6KE300	P6KE300C	243.0	270.00	330.00	1	430.0	1.40	5
P6KE300A	P6KE300CA	256.0	285.00	315.00	1	414.0	1.45	5
P6KE350	P6KE350C	284.0	315.00	385.00	1	504.0	1.19	5
P6KE350A	P6KE350CA	299.3	332.50	367.50	1	482.0	1.24	5
P6KE380	P6KE380C	308.6	342.00	418.00	1	547.2	1.10	5
P6KE380A	P6KE380CA	324.9	361.00	399.00	1	524.4	1.14	5
P6KE400	P6KE400C	324.8	360.00	440.00	1	576.0	1.05	5
P6KE400A	P6KE400CA	342.0	380.00	420.00	1	552.0	1.09	5
P6KE440	P6KE440C	357.3	396.00	484.00	1	633.6	0.95	5
P6KE440A	P6KE440CA	376.2	418.00	462.00	1	607.2	0.99	5
P6KE500	P6KE500C	406.0	450.00	550.00	1	720.0	0.83	5
P6KE500A	P6KE500CA	427.5	475.00	525.00	1	690.0	0.87	5
P6KE520	P6KE520C	422.2	468.00	572.00	1	748.8	0.80	5
P6KE520A	P6KE520CA	444.6	494.00	546.00	1	717.6	0.84	5
P6KE550	P6KE550C	446.6	495.00	605.00	1	792.0	0.76	5
P6KE550A	P6KE550CA	470.3	522.50	577.50	1	759.0	0.79	5
P6KE600	P6KE600C	487.2	540.00	660.00	1	864.0	0.69	5
P6KE600A	P6KE600CA	513.0	570.00	630.00	1	828.0	0.72	5

**Note:**

1. Suffix 'A' denotes 5% tolerance device. Without 'A' denotes 10% tolerance device
2. Add suffix 'C' or 'CA' after part number to specify Bi-directional devices
3. For Bi-Directional devices having  $V_R$  of 10 volts and under, the  $I_R$  limit is double

# Axial Lead Transient Voltage Suppressors (TVS)

**P6KE Series 6.8 To 600 V 600W**

**Ratings and Characteristic Curves ( $T_A=25^\circ\text{C}$  unless otherwise noted)**

**Figure 1 - Peak Pulse Power Rating Curve**

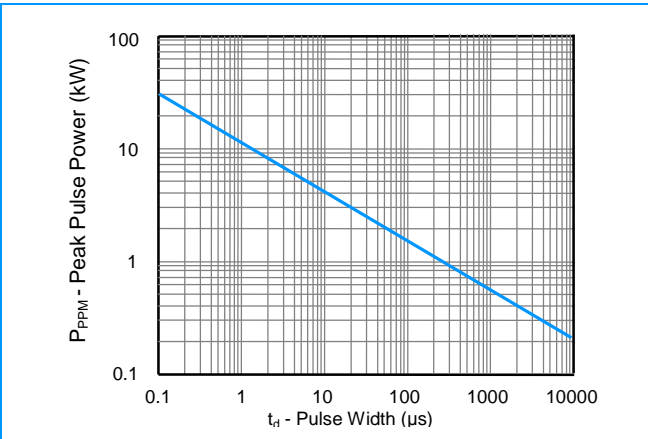

**Figure 2 - Pulse Derating Curve**

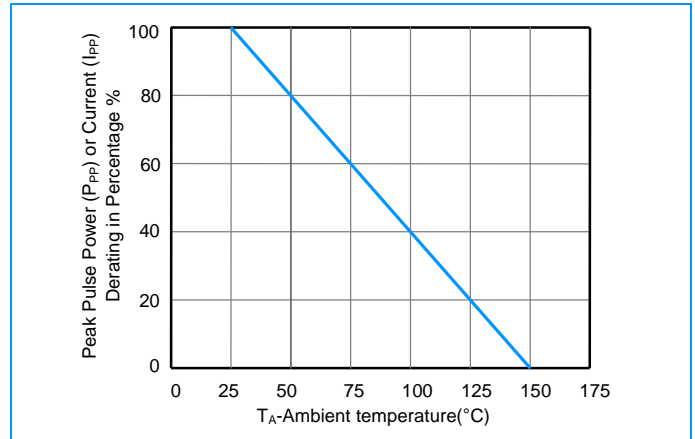

**Figure 3 - Pulse Waveform**

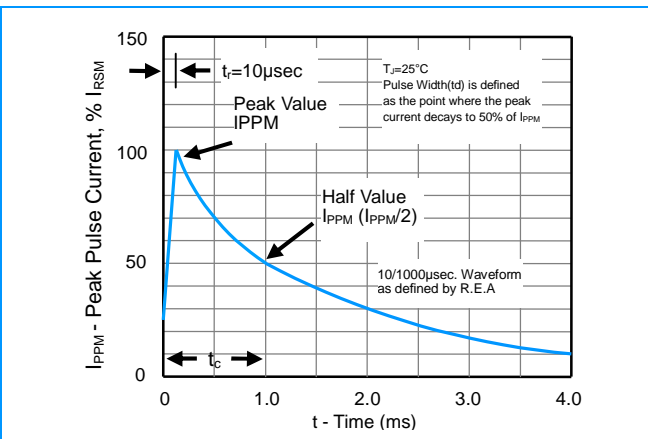

**Figure 4 - Typical Junction Capacitance**

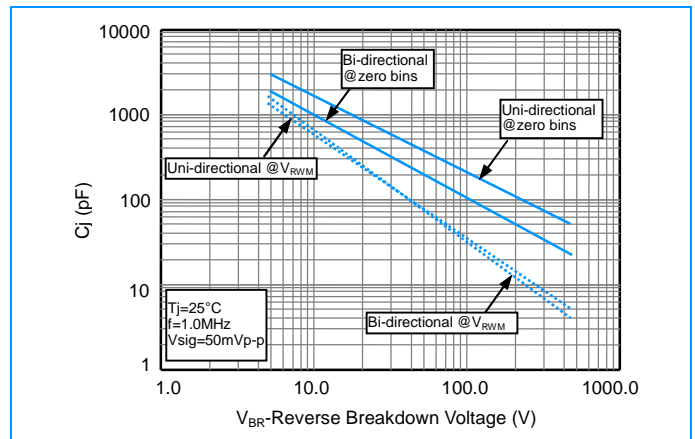

**Figure 5 - Steady State Power Derating Curve**

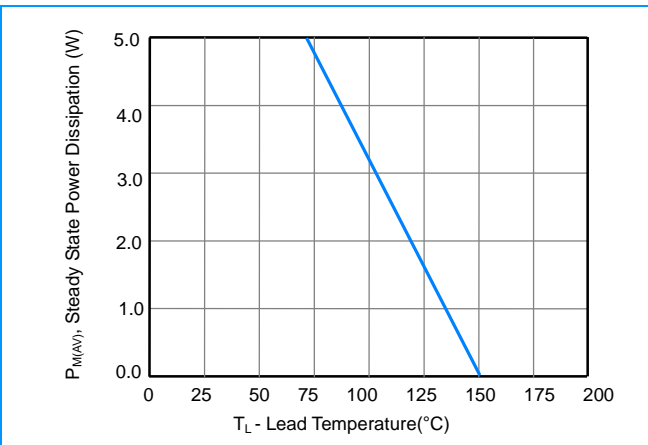

**Figure 6 - Maximum Non-Repetitive Surge Current**

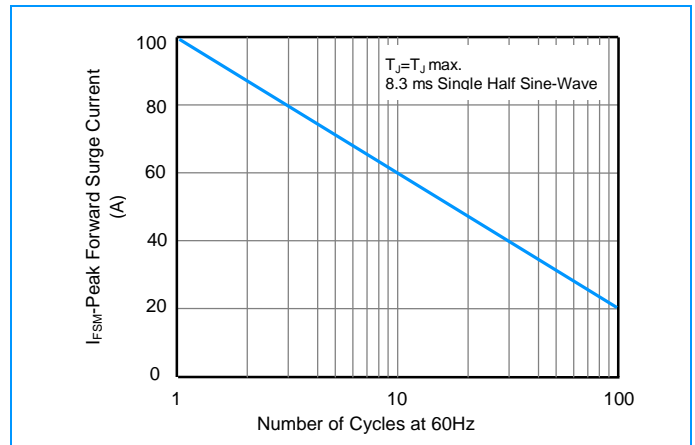

# Axial Lead Transient Voltage Suppressors (TVS)

**P6KE Series 6.8 To 600 V 600W**

## I-V Curve Characteristics

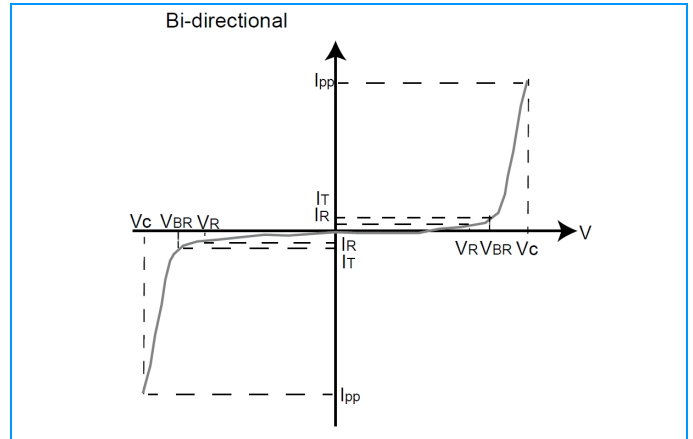
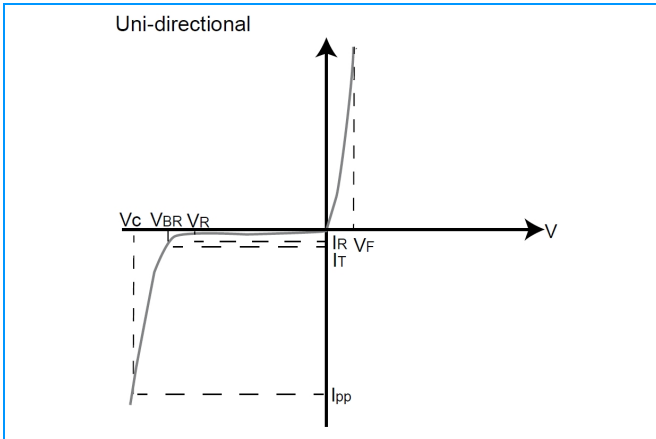

## Physical Specifications

<b>Weight</b>	0.015 ounce, 0.4 gram
<b>Case</b>	JEDEC DO-204AC (DO-15) Molded Plastic over glass passivated junction
<b>Polarity</b>	Color band denotes cathode except Bipolar
<b>Terminal</b>	Matte Tin-plated leads, Solderable per JESD22-B102D

## Environmental Specifications

<b>Temperature Cycle</b>	JESD22-A104
<b>Pressure Cooker</b>	JESD22-A102
<b>High Temp. Storage</b>	JESD22-A103
<b>HTRB</b>	JESD22-A108
<b>Thermal Shock</b>	JESD22-A106

## Soldering Parameters

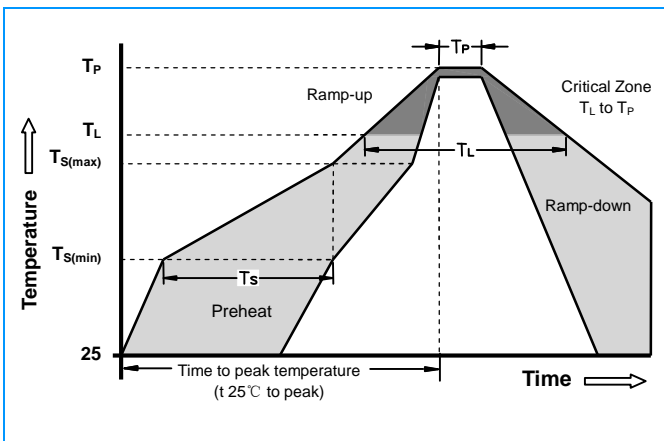

Reflow Condition		Lead-free assembly
Pre Heat	-Temperature Min ( $T_{s(min)}$ )	150°C
	-Temperature Max ( $T_{s(max)}$ )	200°C
	- Time (min to max) ( $t_s$ )	60 -180 Seconds
Average ramp up rate ( Liquidus Temp $T_L$ ) to peak		3°C/second max
$T_{s(max)}$ to $T_L$ - Ramp-up Rate		3°C/second max
Reflow	- Temperature ( $T_L$ ) (Liquidus)	217°C
	- Time (min to max) ( $t_s$ )	60 -150 Seconds
Peak Temperature ( $T_p$ )		260 +0/-5°C
Time within 5°C of actual peak Temperature ( $t_p$ )		20 -40 Seconds
Ramp-down Rate		6°C/second max
Time 25°C to peak Temperature ( $T_p$ )		8 minutes Max
Do not exceed		280°C

# Axial Lead Transient Voltage Suppressors (TVS)

**P6KE Series 6.8 To 600 V 600W**

## Dimensions

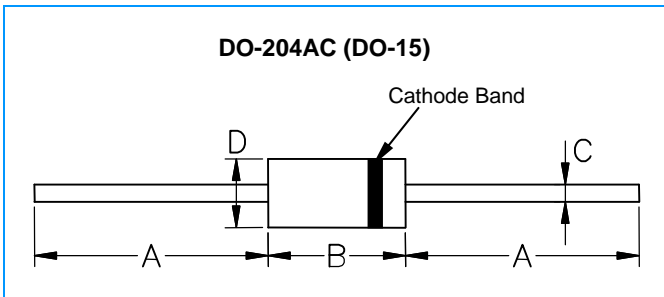

Dimensions	Inches		Millimeters	
	Min	Max	Min	Max
A	1.000	-	25.40	-
B	0.230	0.300	5.85	7.63
C	0.028	0.033	0.71	0.84
D	0.102	0.142	2.60	3.61

## Part Numbering

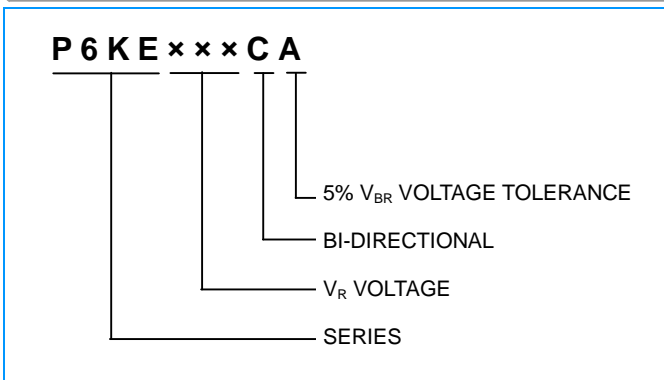

## Part Marking

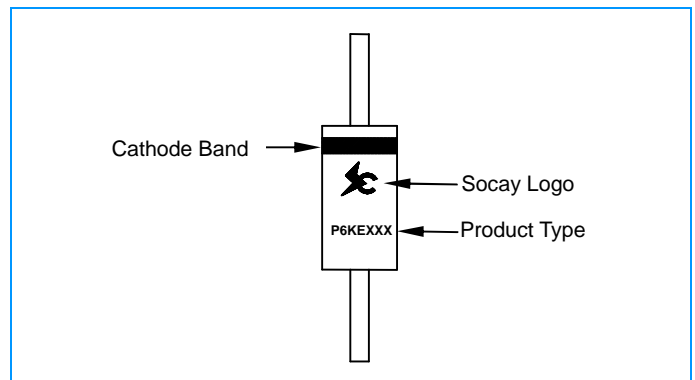

## Packaging

Part Number	Component Package	Quantity	Packaging Option
P6KExxxxx	<b>DO-204AC (DO-15)</b>	2000	Box

## Packaging Dimensions Unit: Inches (Millimeters)

