

GE75NF60

N-CHANNEL ENHANCEMENT MODE POWER MOSFET

BVDSS	60V
RDS(ON)	12mΩ
ID	75A

Description

The GE75NF60 uses advanced trench technology to provide excellent on-resistance extremely efficient and cost-effectiveness device.

The through-hole version (TO-220) is available for low-profile applications and suited for low voltage applications such as DC/DC converters.

Features

- *High Density Cell Design for Ultra Low On-Resistance
- *High power and Current handing capability

Package Dimensions

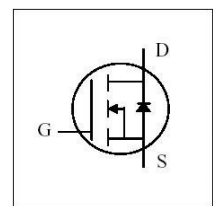
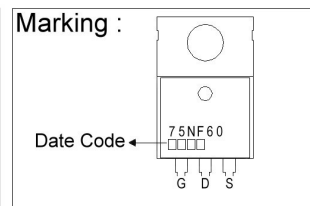
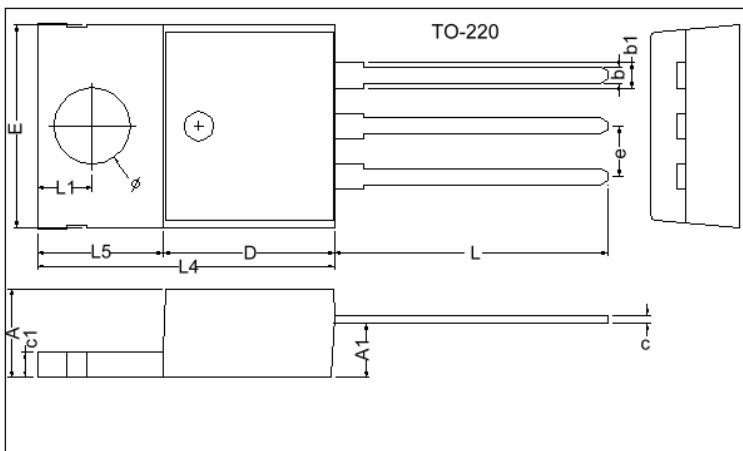

REF.	Millimeter		REF.	Millimeter	
	Min.	Max.		Min.	Max.
A	4.40	4.80	c1	1.25	1.45
b	0.76	1.00	b1	1.17	1.47
c	0.36	0.50	L	13.25	14.25
D	8.60	9.00	e	2.54 REF.	
E	9.80	10.4	L1	2.60	2.89
L4	14.7	15.3	Ø	3.71	3.96
L5	6.20	6.60	A1	2.60	2.80

Absolute Maximum Ratings

Parameter	Symbol	Ratings	Unit
Drain-Source Voltage	V_{DS}	60	V
Gate-Source Voltage	V_{GS}	±25	V
Continuous Drain Current	$I_D @ T_C=25^\circ C$	75	A
Continuous Drain Current	$I_D @ T_C=100^\circ C$	56	A
Pulsed Drain Current ¹	I_{DM}	200	A
Total Power Dissipation	$P_D @ T_C=25^\circ C$	268	W
Linear Derating Factor		1.78	W/°C
Single Pulse Avalanche Energy ²	E_{AS}	350	mJ
Single Pulse Avalanche Current	I_{AS}	38	A
Operating Junction and Storage Temperature Range	T_j, T_{stg}	-55 ~ +175	°C

Thermal Data

Parameter	Symbol	Value	Unit
Thermal Resistance Junction-case Max.	$R_{thj-case}$	0.56	°C/W
Thermal Resistance Junction-ambient Max.	$R_{thj-amb}$	60	°C/W

Electrical Characteristics (T_j = 25°C unless otherwise specified)

Parameter	Symbol	Min.	Typ.	Max.	Unit	Test Conditions
Drain-Source Breakdown Voltage	BV _{DSS}	60	-	-	V	V _{GS} =0, I _D =250uA
Gate Threshold Voltage	V _{GS(th)}	2.0	-	4.0	V	V _{DS} =V _{GS} , I _D =250uA
Forward Transconductance	g _{fs}	-	34	-	S	V _{DS} =15V, I _D =40A
Gate-Source Leakage Current	I _{GSS}	-	-	±100	nA	V _{GS} = ±25V
Drain-Source Leakage Current(T _j =25°C)	I _{DSS}	-	-	1	uA	V _{DS} =60, V _{GS} =0
Drain-Source Leakage Current(T _j =55°C)		-	-	5	uA	V _{DS} =48V, V _{GS} =0
Static Drain-Source On-Resistance ³	R _{DS(ON)}	-	-	12	mΩ	V _{GS} =10V, I _D =37.5A
Total Gate Charge ³	Q _g	-	114	-	nC	I _D =30A V _{DS} =30V V _{GS} =10V
Gate-Source Charge	Q _{gs}	-	33	-		
Gate-Drain ("Miller") Change	Q _{gd}	-	18	-		
Turn-on Delay Time ³	T _{d(on)}	-	21	-	ns	V _{DS} =30V V _{GS} =10V R _G =3Ω R _L =1Ω
Rise Time	T _r	-	39	-		
Turn-off Delay Time	T _{d(off)}	-	70	-		
Fall Time	T _f	-	24	-		
Input Capacitance	C _{iss}	-	7000	-	pF	V _{GS} =0V V _{DS} =30V f=1.0MHz
Output Capacitance	C _{oss}	-	400	-		
Reverse Transfer Capacitance	C _{rss}	-	87	-		

Source-Drain Diode

Parameter	Symbol	Min.	Typ.	Max.	Unit	Test Conditions
Forward On Voltage ³	V _{SD}	-	-	1.5	V	I _S =75A, V _{GS} =0V, T _j =25°C
Reverse Recovery Time ³	T _{rr}	-	53	-	ns	I _S =30A, V _{GS} =0V di/dt=100A/μs
Reverse Recovery Charge	Q _{rr}	-	143	-	nC	
Continuous Source Current (Body Diode)	I _S	-	-	75	A	V _D = V _G =0V, V _S =1.5V

Notes: 1. Pulse width limited by safe operating area.

2. Starting T_j=25°C, V_{DD}=20V, L=0.1mH, R_G=25Ω, I_{AS}=20A.

3. Pulse width ≤ 300us, duty cycle ≤ 2%.

Characteristics Curve

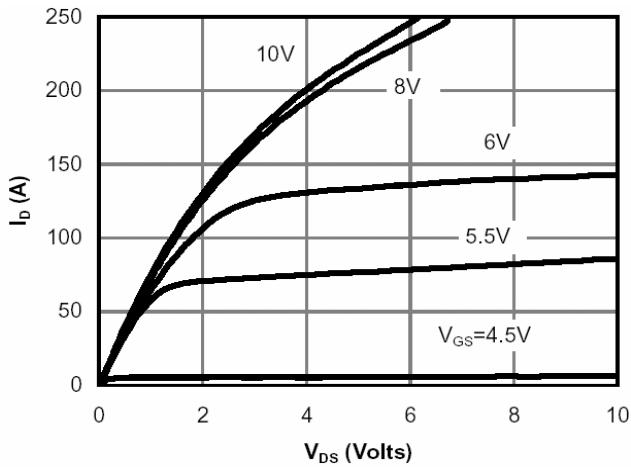

Fig 1. Typical Output Characteristics

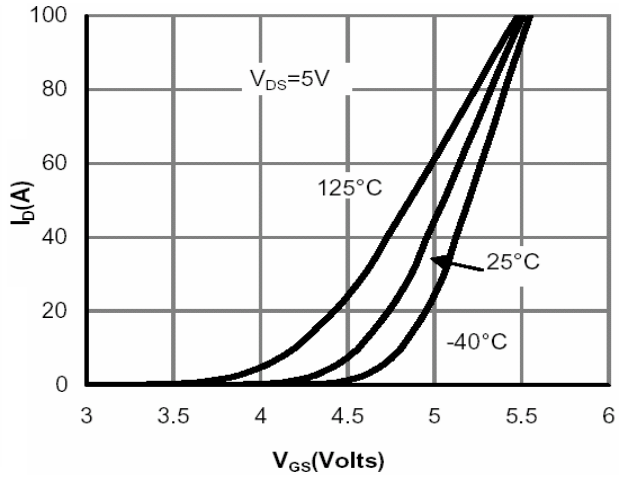

Fig 2. Transfer Characteristics

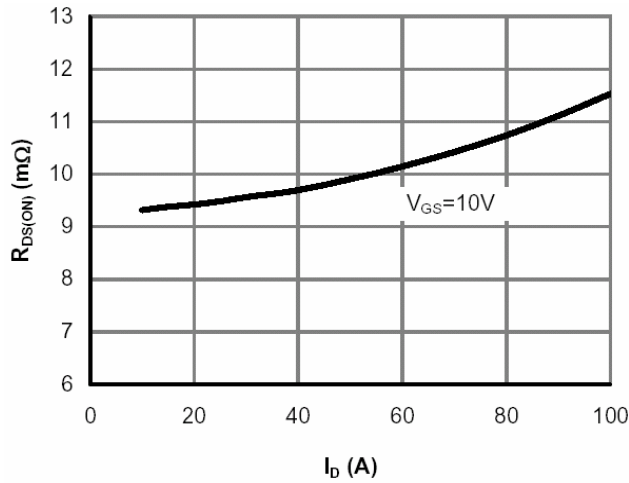

Fig 3. On-Resistance v.s. Drain Current and Gate Voltage

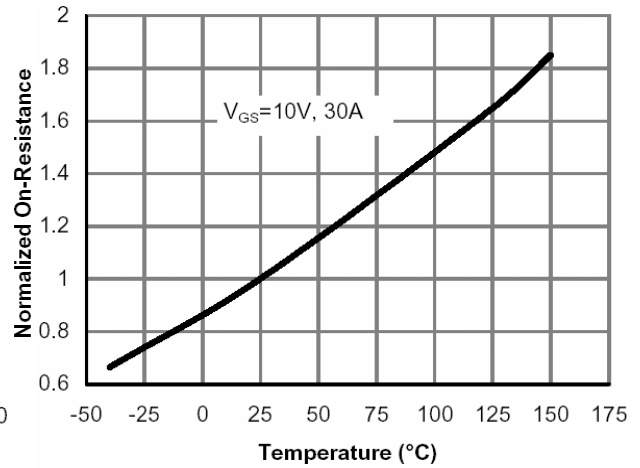

Fig 4. On-Resistance v.s. Junction Temperature

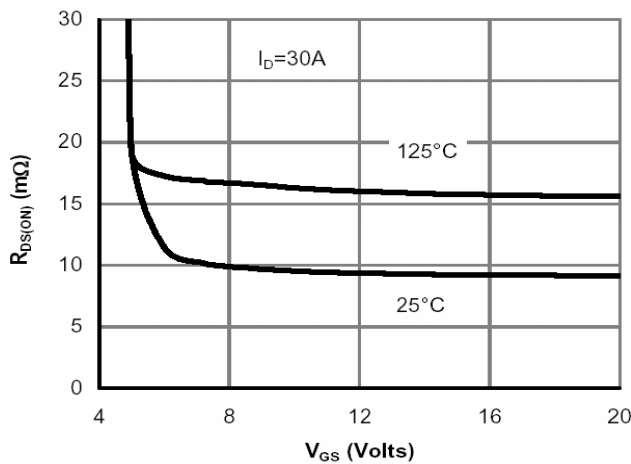

Fig 5. On-Resistance v.s. Gate-Source Voltage

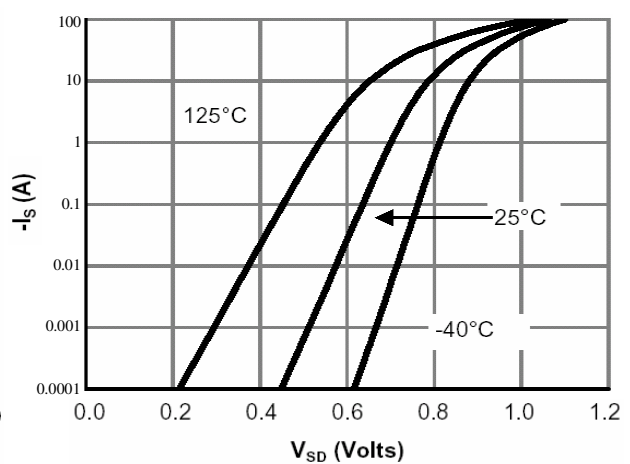

Fig 6. Body Diode Characteristics

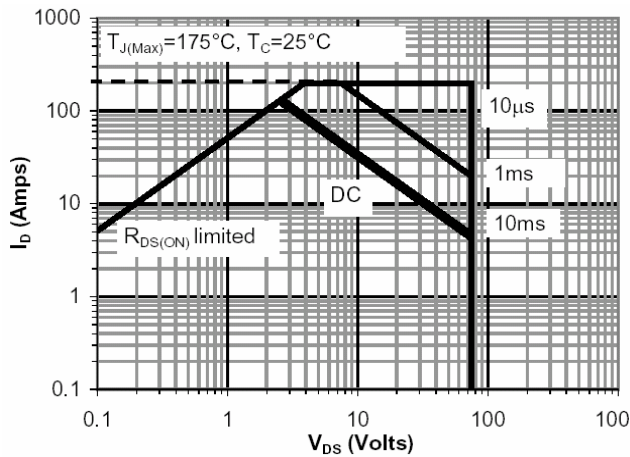

Fig 7. Maximum Safe Operating Area

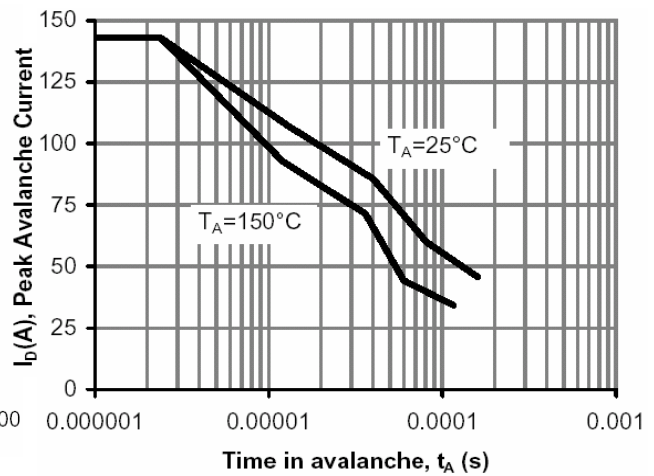

Fig 8. Single Pulse Avalanche Capability

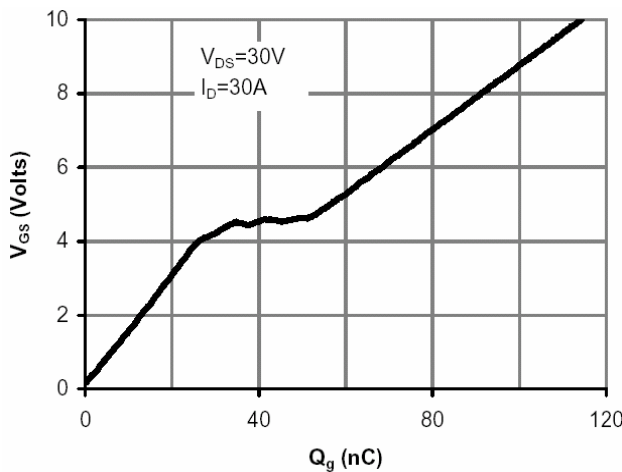

Fig 9. Gate Charge Characteristics

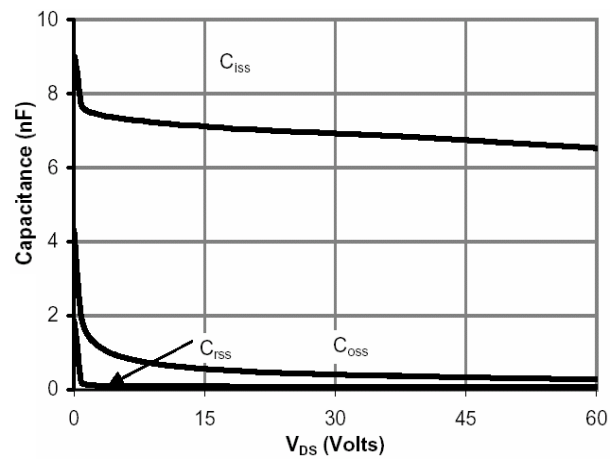

Fig 10. Typical Capacitance Characteristics

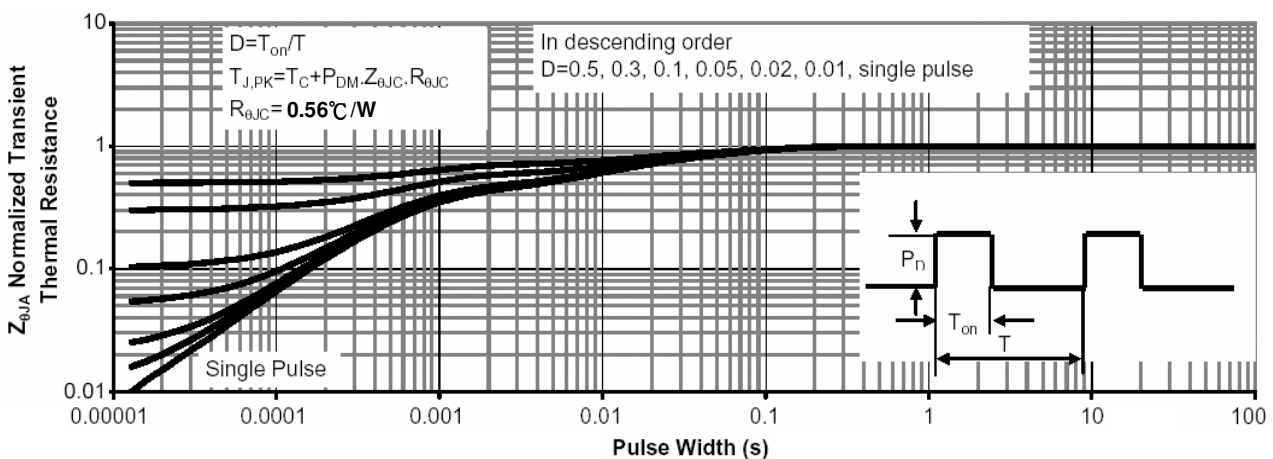

Fig 11. Normalized Maximum Transient Thermal Impedance

Important Notice:

- All rights are reserved. Reproduction in whole or in part is prohibited without the prior written approval of GTM.
- GTM reserves the right to make changes to its products without notice.
- GTM semiconductor products are not warranted to be suitable for use in life-support Applications, or systems.
- GTM assumes no liability for any consequence of customer product design, infringement of patents, or application assistance.

Head Office And Factory:

- Taiwan:** No. 17-1 Tatung Rd. Fu Kou Hsin-Chu Industrial Park, Hsin-Chu, Taiwan, R. O. C.
- TEL : 886-3-597-7061 FAX : 886-3-597-9220, 597-0785
- China:** (201203) No.255, Jang-Jiang Tsai-Lueng RD. , Pu-Dung-Hsin District, Shang-Hai City, China
- TEL : 86-21-5895-7671 ~ 4 FAX : 86-21-38950165