

# Chip Monolithic Ceramic Capacitors for Automotive

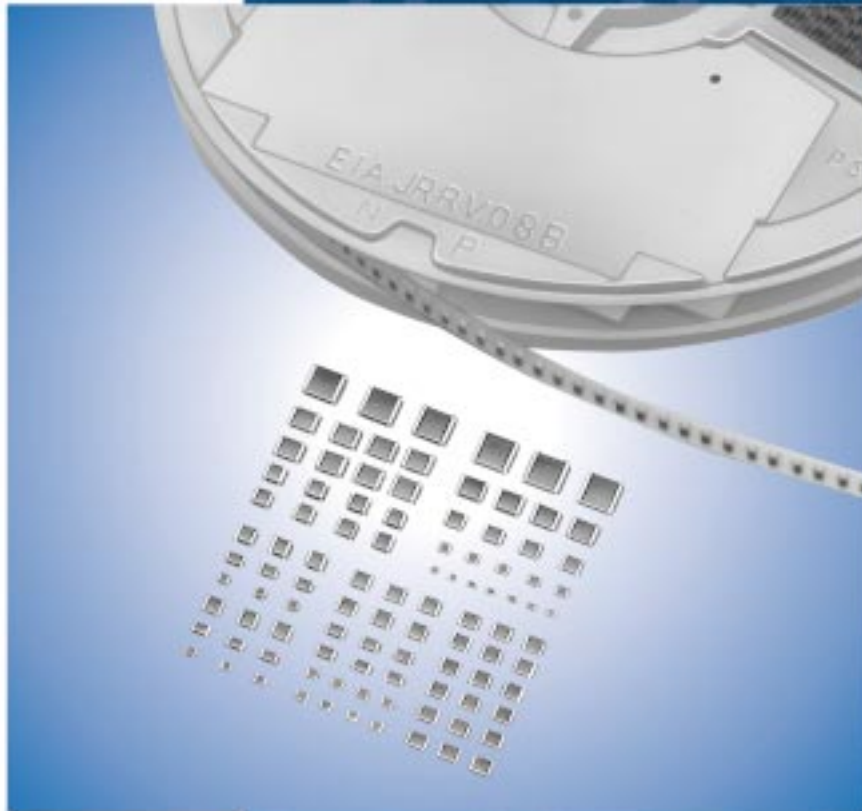

● Part Numbering

Chip Monolithic Ceramic Capacitors

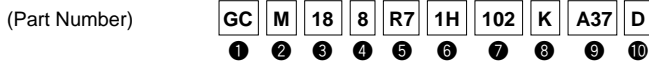

① Product ID

② Series

| Product ID | Code     | Series  |
|------------|----------|---|
| <b>GC</b>  | <b>J</b> | Soft Termination Type Power-train, Safety Equipment |
|            | <b>M</b> | Power-train, Safety Equipment                       |

③ Dimension (L×W)

| Code      | Dimension (L×W) | EIA  |
|-----------|-----------------|------|
| <b>03</b> | 0.6×0.3mm       | 0201 |
| <b>15</b> | 1.0×0.5mm       | 0402 |
| <b>18</b> | 1.6×0.8mm       | 0603 |
| <b>21</b> | 2.0×1.25mm      | 0805 |
| <b>31</b> | 3.2×1.6mm       | 1206 |
| <b>32</b> | 3.2×2.5mm       | 1210 |
| <b>43</b> | 4.5×3.2mm       | 1812 |
| <b>55</b> | 5.7×5.0mm       | 2220 |

④ Dimension (T)

| Code     | Dimension (T)                    |
|----------|----------------------------------|
| <b>3</b> | 0.3mm                            |
| <b>5</b> | 0.5mm                            |
| <b>6</b> | 0.6mm                            |
| <b>8</b> | 0.8mm                            |
| <b>9</b> | 0.85mm                           |
| <b>A</b> | 1.0mm                            |
| <b>B</b> | 1.25mm                           |
| <b>C</b> | 1.6mm                            |
| <b>D</b> | 2.0mm                            |
| <b>E</b> | 2.5mm                            |
| <b>M</b> | 1.15mm                           |
| <b>N</b> | 1.35mm                           |
| <b>Q</b> | 1.5mm                            |
| <b>R</b> | 1.8mm                            |
| <b>X</b> | Depends on individual standards. |

⑤ Temperature Characteristics

| Temperature Characteristic Codes |                 |     | Temperature Characteristics |                   |   | Operating Temperature Range |
|----------------------------------|-----------------|-----|-----------------------------|-------------------|---|-----------------------------|
| Code                             | Public STD Code |     | Reference Temperature       | Temperature Range | Capacitance Change or Temperature Coefficient |                             |
| <b>5C</b>                        | C0G             | EIA | 25°C                        | 25 to 125°C       | 0±30ppm/°C                                    | -55 to 125°C                |
| <b>7U</b>                        | U2J             | EIA | 25°C                        | 25 to 125°C       | -750±120ppm/°C                                | -55 to 125°C                |
| <b>C7</b>                        | X7S             | EIA | 25°C                        | -55 to 125°C      | ±22%  | -55 to 125°C                |
| <b>R7</b>                        | X7R             | EIA | 25°C                        | -55 to 125°C      | ±15%  | -55 to 125°C                |

● Capacitance Change from each temperature

| Murata Code | Capacitance Change from 25°C (%) |       |       |       |       |       |
|-------------|----------------------------------|-------|-------|-------|-------|-------|
|             | -55°C                            |       | -30°C |       | -10°C |       |
|             | Max.                             | Min.  | Max.  | Min.  | Max.  | Min.  |
| <b>5C</b>   | 0.58                             | -0.24 | 0.40  | -0.17 | 0.25  | -0.11 |
| <b>7U</b>   | 8.78                             | 5.04  | 6.04  | 3.47  | 3.84  | 2.21  |

⑥ Rated Voltage

| Code      | Rated Voltage |
|-----------|---------------|
| <b>0J</b> | DC6.3V        |
| <b>1A</b> | DC10V         |
| <b>1C</b> | DC16V         |
| <b>1E</b> | DC25V         |
| <b>YA</b> | DC35V         |
| <b>1H</b> | DC50V         |
| <b>2A</b> | DC100V        |
| <b>2E</b> | DC250V        |
| <b>2J</b> | DC630V        |

⑦ Capacitance

Expressed by three-digit alphanumerics. The unit is pico-farad (pF). The first and second figures are significant digits, and the third figure expresses the number of zeros which follow the two numbers.  
 If there is a decimal point, it is expressed by the capital letter "R". In this case, all figures are significant digits.

Ex.)

| Code       | Capacitance |
|------------|-------------|
| <b>R50</b> | 0.5pF       |
| <b>1R0</b> | 1.0pF       |
| <b>100</b> | 10pF        |
| <b>103</b> | 10000pF     |

Continued on the following page.

☐ Continued from the preceding page.

⑧ Capacitance Tolerance

| Code     | Capacitance Tolerance | TC       | Series         | Capacitance Step |                 |
|----------|-----------------------|----------|----------------|------------------|-----------------|
| <b>C</b> | ±0.25pF               | C0G      | <b>GCM</b>     | ≤5pF             | E12, 1pF Step * |
| <b>D</b> | ±0.5pF                | C0G      | <b>GCM</b>     | 6.0 to 9.0pF     | E12, 1pF Step * |
| <b>J</b> | ±5%                   | C0G      | <b>GCM</b>     | ≥10pF            | E12 Step        |
|          |                       | U2J      | <b>GCM</b>     |                  | E12 Step        |
| <b>K</b> | ±10%                  | X7S, X7R | <b>GCJ/GCM</b> | E6 Step          |                 |
| <b>M</b> | ±20%                  | X7S, X7R | <b>GCM</b>     | E6 Step          |                 |

\* E24 series is also available.

⑨ Individual Specification Code

Expressed by three figures.

⑩ Package

| Code     | Package                |
|----------|------------------------|
| <b>L</b> | ø180mm Embossed Taping |
| <b>D</b> | ø180mm Paper Taping    |
| <b>K</b> | ø330mm Embossed Taping |
| <b>J</b> | ø330mm Paper Taping    |
| <b>B</b> | Bulk                   |
| <b>C</b> | Bulk Case              |

# Chip Monolithic Ceramic Capacitors for Automotive



## for Automotive GCM Series

### ■ Features

1. The GCM series meet AEC-Q200 requirements.
2. Higher resistance of solder-leaching due to the Ni-barriered termination, applicable for reflow-soldering, and flow-soldering (GCM18/21/31 type only).
3. The operating temperature range of R7/C7/5C series: -55 to 125 degree C.
4. A wide selection of sizes is available, from miniature LxWxT:0.6x0.3x0.3mm to LxWxT: 3.2x2.5x2.5mm.
5. The GCM series is available in paper or embossed tape and reel packaging for automatic placement.
6. The GCM series is lead free product.

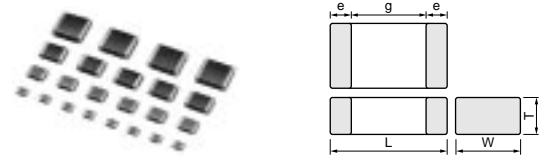

| Part Number    | Dimensions (mm) |            |            |              |        |
|----------------|-----------------|------------|------------|--------------|--------|
|                | L               | W          | T          | e            | g min. |
| <b>GCM033</b>  | 0.6 ±0.03       | 0.3 ±0.03  | 0.3 ±0.03  | 0.1 to 0.2   | 0.2    |
| <b>GCM155</b>  | 1.0 ±0.05       | 0.5 ±0.05  | 0.5 ±0.05  | 0.15 to 0.35 | 0.3    |
| <b>GCM188*</b> | 1.6 ±0.1        | 0.8 ±0.1   | 0.8 ±0.1   | 0.2 to 0.5   | 0.5    |
| <b>GCM216</b>  |                 |            | 0.6 ±0.1   |              |        |
| <b>GCM219</b>  | 2.0 ±0.15       | 1.25 ±0.15 | 0.85 ±0.1  | 0.2 to 0.7   | 0.7    |
| <b>GCM21B</b>  |                 |            | 1.25 ±0.15 |              |        |
| <b>GCM319</b>  |                 |            | 0.85 ±0.1  |              |        |
| <b>GCM31M</b>  | 3.2 ±0.15       | 1.6 ±0.15  | 1.15 ±0.1  | 0.3 to 0.8   | 1.5    |
| <b>GCM31C</b>  | 3.2 ±0.2        | 1.6 ±0.2   | 1.6 ±0.2   |              |        |
| <b>GCM32N</b>  |                 |            | 1.35 ±0.15 |              |        |
| <b>GCM32R</b>  | 3.2 ±0.3        | 2.5 ±0.2   | 1.8 ±0.2   | 0.3 min.     | 1.0    |
| <b>GCM32D</b>  |                 |            | 2.0 ±0.2   |              |        |
| <b>GCM32E</b>  |                 |            | 2.5 ±0.2   |              |        |

\* Bulk Case: 1.6 ±0.07(L) × 0.8 ±0.07(W) × 0.8 ±0.07(T)  
 The figure indicates typical specification.

### ■ Applications

Automotive electronic equipment (Power-train, safety equipment)

# Capacitance Table

## Temperature Compensating Type C0G(5C)

6 ex.6: T Dimension Part Number Code

| Capacitance         | LxW [mm] | 0.6x0.3<br>(03) |         | 1.0x0.5<br>(15) |         | 1.6x0.8<br>(18) |         | 2.0x1.25<br>(21) |         | 3.2x1.6<br>(31) |         |
|---------------------|----------|-----------------|---------|-----------------|---------|-----------------|---------|------------------|---------|-----------------|---------|
|                     |          | <020>           | <040>   | <060>           | <080>   | <100>           | <125>   | <160>            | <200>   |                 |         |
| Rated Voltage [Vdc] |          | 25 (1E)         | 50 (1H) | 100 (2A)        | 50 (1H) | 100 (2A)        | 50 (1H) | 100 (2A)         | 50 (1H) | 100 (2A)        | 50 (1H) |
| 1.0pF(1R0)          |          | 3               | 5       | 8               | 8       |                 |         |                  |         |                 |         |
| 2.0pF(2R0)          |          | 3               | 5       | 8               | 8       |                 |         |                  |         |                 |         |
| 3.0pF(3R0)          |          | 3               | 5       | 8               | 8       |                 |         |                  |         |                 |         |
| 4.0pF(4R0)          |          | 3               | 5       | 8               | 8       |                 |         |                  |         |                 |         |
| 5.0pF(5R0)          |          | 3               | 5       | 8               | 8       |                 |         |                  |         |                 |         |
| 6.0pF(6R0)          |          | 3               | 5       | 8               | 8       |                 |         |                  |         |                 |         |
| 7.0pF(7R0)          |          | 3               | 5       | 8               | 8       |                 |         |                  |         |                 |         |
| 8.0pF(8R0)          |          | 3               | 5       | 8               | 8       |                 |         |                  |         |                 |         |
| 9.0pF(9R0)          |          | 3               | 5       | 8               | 8       |                 |         |                  |         |                 |         |
| 10pF(100)           |          | 3               | 5       | 8               | 8       |                 |         |                  |         |                 |         |
| 12pF(120)           |          | 3               | 5       | 8               | 8       |                 |         |                  |         |                 |         |
| 15pF(150)           |          | 3               | 5       | 8               | 8       |                 |         |                  |         |                 |         |
| 18pF(180)           |          | 3               | 5       | 8               | 8       |                 |         |                  |         |                 |         |
| 22pF(220)           |          | 3               | 5       | 8               | 8       |                 |         |                  |         |                 |         |
| 27pF(270)           |          | 3               | 5       | 8               | 8       |                 |         |                  |         |                 |         |
| 33pF(330)           |          | 3               | 5       | 8               | 8       |                 |         |                  |         |                 |         |
| 39pF(390)           |          | 3               | 5       | 8               | 8       |                 |         |                  |         |                 |         |
| 47pF(470)           |          | 3               | 5       | 8               | 8       |                 |         |                  |         |                 |         |
| 56pF(560)           |          | 3               | 5       | 8               | 8       |                 |         |                  |         |                 |         |
| 68pF(680)           |          | 3               | 5       | 8               | 8       |                 |         |                  |         |                 |         |
| 82pF(820)           |          | 3               | 5       | 8               | 8       |                 |         |                  |         |                 |         |
| 100pF(101)          |          | 3               | 5       | 8               | 8       | 6               |         |                  |         |                 |         |
| 120pF(121)          |          |                 | 5       | 8               | 8       | 6               |         |                  |         |                 |         |
| 150pF(151)          |          |                 | 5       | 8               | 8       | 6               |         |                  |         |                 |         |
| 180pF(181)          |          |                 | 5       | 8               | 8       | 6               |         |                  |         |                 |         |
| 220pF(221)          |          |                 | 5       | 8               | 8       | 6               |         |                  |         |                 |         |
| 270pF(271)          |          |                 | 5       | 8               | 8       | 6               |         |                  |         |                 |         |
| 330pF(331)          |          |                 | 5       | 8               | 8       | 6               |         |                  |         |                 |         |
| 390pF(391)          |          |                 | 5       | 8               | 8       | 6               |         |                  |         |                 |         |
| 470pF(471)          |          |                 | 5       | 8               | 8       | 6               |         |                  |         |                 |         |
| 560pF(561)          |          |                 |         | 8               | 8       | 6               | 6       |                  |         |                 |         |
| 680pF(681)          |          |                 |         | 8               | 8       | 6               | 6       |                  |         |                 |         |
| 820pF(821)          |          |                 |         | 8               | 8       | 6               | 6       |                  |         |                 |         |
| 1000pF(102)         |          |                 |         | 8               | 8       | 6               | 6       |                  |         |                 |         |
| 1200pF(122)         |          |                 |         | 8               | 8       | 6               | 6       |                  |         |                 |         |
| 1500pF(152)         |          |                 |         | 8               | 8       | 6               | 6       |                  |         |                 |         |
| 1800pF(182)         |          |                 |         |                 | 8       | 6               | 6       | 9                |         |                 |         |
| 2200pF(222)         |          |                 |         |                 | 8       | 6               | 6       | 9                |         |                 |         |
| 2700pF(272)         |          |                 |         |                 | 8       | 6               | 6       | 9                |         |                 |         |
| 3300pF(332)         |          |                 |         |                 | 8       | 6               | 6       | 9                |         |                 |         |
| 3900pF(392)         |          |                 |         |                 | 8       |                 | 6       | 9                |         |                 |         |
| 4700pF(472)         |          |                 |         |                 |         |                 | 6       | 9                | 9       |                 |         |
| 5600pF(562)         |          |                 |         |                 |         |                 | 9       | 9                | 9       |                 |         |
| 6800pF(682)         |          |                 |         |                 |         |                 | 9       | 9                | 9       |                 |         |
| 8200pF(822)         |          |                 |         |                 |         |                 | 9       | 9                | 9       |                 |         |
| 10000pF(103)        |          |                 |         |                 |         |                 | 9       | 9                | 9       |                 |         |
| 12000pF(123)        |          |                 |         |                 |         |                 | 9       |                  | 9       |                 |         |
| 15000pF(153)        |          |                 |         |                 |         |                 | 9       |                  | 9       |                 |         |
| 18000pF(183)        |          |                 |         |                 |         |                 | B       |                  | 9       |                 |         |
| 22000pF(223)        |          |                 |         |                 |         |                 | B       |                  | 9       |                 |         |
| 27000pF(273)        |          |                 |         |                 |         |                 |         |                  | 9       |                 |         |
| 33000pF(333)        |          |                 |         |                 |         |                 |         |                  | 9       |                 |         |
| 39000pF(393)        |          |                 |         |                 |         |                 |         |                  | 9       |                 |         |
| 47000pF(473)        |          |                 |         |                 |         |                 |         |                  | M       |                 |         |
| 56000pF(563)        |          |                 |         |                 |         |                 |         |                  | M       |                 |         |

The part numbering code is shown in ( ) and Unit is shown in [ ]. < >: EIA [inch] Code





## Temperature Compensating Type

| L x W [mm]        |           | 2.0x1.25(21)<0805> |                    | 3.2x1.6(31)<1206>  |                    |
|-------------------|-----------|--------------------|--------------------|--------------------|--------------------|
| Rated Volt. [Vdc] |           | 100(2A)            | 50(1H)             | 100(2A)            | 50(1H)             |
| TC                |           | COG(5C)            |                    |                    |                    |
| Capacitance       | Tolerance | Part Number        |                    |                    |                    |
| 100pF(101)        | ±5%(J)    | GCM2165C2A101JA16D |                    |                    |                    |
| 120pF(121)        | ±5%(J)    | GCM2165C2A121JA16D |                    |                    |                    |
| 150pF(151)        | ±5%(J)    | GCM2165C2A151JA16D |                    |                    |                    |
| 180pF(181)        | ±5%(J)    | GCM2165C2A181JA16D |                    |                    |                    |
| 220pF(221)        | ±5%(J)    | GCM2165C2A221JA16D |                    |                    |                    |
| 270pF(271)        | ±5%(J)    | GCM2165C2A271JA16D |                    |                    |                    |
| 330pF(331)        | ±5%(J)    | GCM2165C2A331JA16D |                    |                    |                    |
| 390pF(391)        | ±5%(J)    | GCM2165C2A391JA16D |                    |                    |                    |
| 470pF(471)        | ±5%(J)    | GCM2165C2A471JA16D |                    |                    |                    |
| 560pF(561)        | ±5%(J)    | GCM2165C2A561JA16D | GCM2165C1H561JA16D |                    |                    |
| 680pF(681)        | ±5%(J)    | GCM2165C2A681JA16D | GCM2165C1H681JA16D |                    |                    |
| 820pF(821)        | ±5%(J)    | GCM2165C2A821JA16D | GCM2165C1H821JA16D |                    |                    |
| 1000pF(102)       | ±5%(J)    | GCM2165C2A102JA16D | GCM2165C1H102JA16D |                    |                    |
| 1200pF(122)       | ±5%(J)    | GCM2165C2A122JA16D | GCM2165C1H122JA16D |                    |                    |
| 1500pF(152)       | ±5%(J)    | GCM2165C2A152JA16D | GCM2165C1H152JA16D |                    |                    |
| 1800pF(182)       | ±5%(J)    | GCM2165C2A182JA16D | GCM2165C1H182JA16D | GCM3195C2A182JA16D |                    |
| 2200pF(222)       | ±5%(J)    | GCM2165C2A222JA16D | GCM2165C1H222JA16D | GCM3195C2A222JA16D |                    |
| 2700pF(272)       | ±5%(J)    | GCM2165C2A272JA16D | GCM2165C1H272JA16D | GCM3195C2A272JA16D |                    |
| 3300pF(332)       | ±5%(J)    | GCM2165C2A332JA16D | GCM2165C1H332JA16D | GCM3195C2A332JA16D |                    |
| 3900pF(392)       | ±5%(J)    |                    | GCM2165C1H392JA16D | GCM3195C2A392JA16D |                    |
| 4700pF(472)       | ±5%(J)    |                    | GCM2165C1H472JA16D | GCM3195C2A472JA16D | GCM3195C1H472JA16D |
| 5600pF(562)       | ±5%(J)    |                    | GCM2195C1H562JA16D | GCM3195C2A562JA16D | GCM3195C1H562JA16D |
| 6800pF(682)       | ±5%(J)    |                    | GCM2195C1H682JA16D | GCM3195C2A682JA16D | GCM3195C1H682JA16D |
| 8200pF(822)       | ±5%(J)    |                    | GCM2195C1H822JA16D | GCM3195C2A822JA16D | GCM3195C1H822JA16D |
| 10000pF(103)      | ±5%(J)    |                    | GCM2195C1H103JA16D | GCM3195C2A103JA16D | GCM3195C1H103JA16D |
| 12000pF(123)      | ±5%(J)    |                    | GCM2195C1H123JA16D |                    | GCM3195C1H123JA16D |
| 15000pF(153)      | ±5%(J)    |                    | GCM2195C1H153JA16D |                    | GCM3195C1H153JA16D |
| 18000pF(183)      | ±5%(J)    |                    | GCM21B5C1H183JA16L |                    | GCM3195C1H183JA16D |
| 22000pF(223)      | ±5%(J)    |                    | GCM21B5C1H223JA16L |                    | GCM3195C1H223JA16D |
| 27000pF(273)      | ±5%(J)    |                    |                    |                    | GCM3195C1H273JA16D |
| 33000pF(333)      | ±5%(J)    |                    |                    |                    | GCM3195C1H333JA16D |
| 39000pF(393)      | ±5%(J)    |                    |                    |                    | GCM3195C1H393JA16D |
| 47000pF(473)      | ±5%(J)    |                    |                    |                    | GCM31M5C1H473JA16L |
| 56000pF(563)      | ±5%(J)    |                    |                    |                    | GCM31M5C1H563JA16L |

The part numbering code is shown in ( ) and Unit is shown in [ ]. < >: EIA [inch] Code





## High Dielectric Constant Type

|                   |           |                    |                    |                    |                    |
|-------------------|-----------|--------------------|--------------------|--------------------|--------------------|
| L x W [mm]        |           | 1.6x0.8(18)<0603>  |                    |                    |                    |
| Rated Volt. [Vdc] |           | 100(2A)            | 50(1H)             | 25(1E)             | 16(1C)             |
| TC                |           | X7R(R7)/X7S(C7)    |                    |                    |                    |
| Capacitance       | Tolerance | Part Number        |                    |                    |                    |
| 1000pF(102)       | ±10%(K)   | GCM188R72A102KA37D | GCM188R71H102KA37D |                    |                    |
| 1500pF(152)       | ±10%(K)   | GCM188R72A152KA37D | GCM188R71H152KA37D |                    |                    |
| 2200pF(222)       | ±10%(K)   | GCM188R72A222KA37D | GCM188R71H222KA37D |                    |                    |
| 3300pF(332)       | ±10%(K)   | GCM188R72A332KA37D | GCM188R71H332KA37D |                    |                    |
| 4700pF(472)       | ±10%(K)   | GCM188R72A472KA37D | GCM188R71H472KA37D |                    |                    |
| 6800pF(682)       | ±10%(K)   | GCM188R72A682KA37D | GCM188R71H682KA37D |                    |                    |
| 10000pF(103)      | ±10%(K)   | GCM188R72A103KA37D | GCM188R71H103KA37D |                    |                    |
| 15000pF(153)      | ±10%(K)   | GCM188R72A153KA37D | GCM188R71H153KA37D |                    |                    |
| 22000pF(223)      | ±10%(K)   | GCM188R72A223KA37D | GCM188R71H223KA37D |                    |                    |
| 33000pF(333)      | ±10%(K)   |                    | GCM188R71H333KA55D | GCM188R71E333KA37D |                    |
| 47000pF(473)      | ±10%(K)   |                    | GCM188R71H473KA55D | GCM188R71E473KA37D |                    |
| 68000pF(683)      | ±10%(K)   |                    | GCM188R71H683KA57D | GCM188R71E683KA57D |                    |
| 0.10μF(104)       | ±10%(K)   | GCM188R72A104KA64D | GCM188R71H104KA57D | GCM188R71E104KA57D | GCM188R71C104KA37D |
| 0.15μF(154)       | ±10%(K)   |                    | GCM188R71H154KA64D | GCM188R71E154KA37D |                    |
| 0.22μF(224)       | ±10%(K)   |                    | GCM188R71H224KA64D | GCM188R71E224KA55D |                    |
| 0.33μF(334)       | ±10%(K)   |                    |                    |                    | GCM188R71C334KA37D |
| 0.47μF(474)       | ±10%(K)   |                    |                    | GCM188R71E474KA64D | GCM188R71C474KA55D |
| 1.0μF(105)        | ±10%(K)   |                    |                    | GCM188R71E105KA64D | GCM188R71C105KA64D |

|                   |           |                    |
|-------------------|-----------|--------------------|
| L x W [mm]        |           | 1.6x0.8(18)<0603>  |
| Rated Volt. [Vdc] |           | 6.3(0J)            |
| TC                |           | X7R(R7)            |
| Capacitance       | Tolerance | Part Number        |
| 2.2μF(225)        | ±10%(K)   | GCM188R70J225KE22D |

The part numbering code is shown in ( ) and Unit is shown in [ ]. < >: EIA [inch] Code

## High Dielectric Constant Type

| L x W [mm]        |           | 2.0x1.25(21)<0805> |                    |                    |                    |
|-------------------|-----------|--------------------|--------------------|--------------------|--------------------|
| Rated Volt. [Vdc] |           | 100(2A)            | 50(1H)             | 35(YA)             | 25(1E)             |
| TC                |           | X7R(R7)            |                    |                    |                    |
| Capacitance       | Tolerance | Part Number        |                    |                    |                    |
| 6800pF(682)       | ±10%(K)   | GCM216R72A682KA37D |                    |                    |                    |
| 10000pF(103)      | ±10%(K)   | GCM216R72A103KA37D |                    |                    |                    |
| 15000pF(153)      | ±10%(K)   | GCM216R72A153KA37D |                    |                    |                    |
| 22000pF(223)      | ±10%(K)   | GCM216R72A223KA37D |                    |                    |                    |
| 33000pF(333)      | ±10%(K)   | GCM219R72A333KA37D | GCM219R71H333KA37D |                    |                    |
| 47000pF(473)      | ±10%(K)   | GCM21BR72A473KA37L | GCM21BR71H473KA37L |                    |                    |
| 68000pF(683)      | ±10%(K)   | GCM21BR72A683KA37L | GCM21BR71H683KA37L |                    |                    |
| 0.10μF(104)       | ±10%(K)   | GCM21BR72A104KA37L | GCM21BR71H104KA37L |                    |                    |
| 0.15μF(154)       | ±10%(K)   |                    | GCM21BR71H154KA37L |                    | GCM21BR71E154KA37L |
| 0.22μF(224)       | ±10%(K)   |                    | GCM21BR71H224KA37L |                    | GCM21BR71E224KA37L |
| 0.33μF(334)       | ±10%(K)   |                    | GCM219R71H334KA55D |                    | GCM21BR71E334KA37L |
| 0.47μF(474)       | ±10%(K)   |                    | GCM21BR71H474KA55L |                    | GCM219R71E474KA55D |
| 0.68μF(684)       | ±10%(K)   |                    |                    | GCM21BR7YA684KA55L | GCM21BR71E684KA55L |
| 1.0μF(105)        | ±10%(K)   |                    |                    | GCM21BR7YA105KA55L | GCM21BR71E105KA56L |
| 2.2μF(225)        | ±10%(K)   |                    |                    |                    | GCM21BR71E225KA73L |

| L x W [mm]        |           | 2.0x1.25(21)<0805> |                    |                    |
|-------------------|-----------|--------------------|--------------------|--------------------|
| Rated Volt. [Vdc] |           | 16(1C)             | 10(1A)             | 6.3(0J)            |
| TC                |           | X7R(R7)/X7S(C7)    |                    |                    |
| Capacitance       | Tolerance | Part Number        |                    |                    |
| 0.68μF(684)       | ±10%(K)   | GCM219R71C684KA37D |                    |                    |
| 1.0μF(105)        | ±10%(K)   | GCM219R71C105KA37D |                    |                    |
| 2.2μF(225)        | ±10%(K)   | GCM21BR71C225KA64L | GCM21BR71A225KA37L |                    |
| 4.7μF(475)        | ±10%(K)   | GCM21BR71C475KA73L | GCM21BC71A475KA73L |                    |
| 10μF(106)         | ±10%(K)   |                    |                    | GCM21BR70J106KE22L |

| L x W [mm]        |           | 3.2x1.6(31)<1206>  |                    |                    |                    |
|-------------------|-----------|--------------------|--------------------|--------------------|--------------------|
| Rated Volt. [Vdc] |           | 100(2A)            | 50(1H)             | 25(1E)             | 16(1C)             |
| TC                |           | X7R(R7)            |                    |                    |                    |
| Capacitance       | Tolerance | Part Number        |                    |                    |                    |
| 0.10μF(104)       | ±10%(K)   | GCM319R72A104KA37D |                    |                    |                    |
| 0.15μF(154)       | ±10%(K)   | GCM31MR72A154KA37L |                    |                    |                    |
| 0.22μF(224)       | ±10%(K)   | GCM31MR72A224KA37L |                    |                    |                    |
| 0.33μF(334)       | ±10%(K)   |                    | GCM31MR71H334KA37L |                    |                    |
| 0.47μF(474)       | ±10%(K)   |                    | GCM31MR71H474KA37L |                    |                    |
| 0.68μF(684)       | ±10%(K)   |                    | GCM31MR71H684KA55L |                    |                    |
| 1.0μF(105)        | ±10%(K)   |                    | GCM31MR71H105KA55L |                    |                    |
| 2.2μF(225)        | ±10%(K)   |                    | GCM31CR71H225KA55L | GCM31MR71E225KA57L |                    |
| 4.7μF(475)        | ±10%(K)   |                    |                    | GCM31CR71E475KA55L | GCM31CR71C475KA37L |
| 10μF(106)         | ±10%(K)   |                    |                    |                    | GCM31CR71C106KA64L |

| L x W [mm]        |           | 3.2x1.6(31)<1206>  |                    |
|-------------------|-----------|--------------------|--------------------|
| Rated Volt. [Vdc] |           | 10(1A)             | 6.3(0J)            |
| TC                |           | X7R(R7)            |                    |
| Capacitance       | Tolerance | Part Number        |                    |
| 10μF(106)         | ±10%(K)   | GCM31CR71A106KA64L |                    |
| 22μF(226)         | ±20%(M)   |                    | GCM31CR70J226ME23L |

The part numbering code is shown in ( ) and Unit is shown in [ ]. < >: EIA [inch] Code

(Part Number) **GC** **M** **21** **6** **R7** **2A** **682** **K** **A37** **D**    ①Product ID    ②Series    ③Dimension (L×W)    ④Dimension (T)  
 ⑤Temperature Characteristics    ⑥Rated Voltage    ⑦Capacitance  
 ⑧Capacitance Tolerance    ⑨Individual Specification Code    ⑩Package

Packaging Code in Part Number is a code shows STD 180mm Reel Taping.

## High Dielectric Constant Type

|                   |           |                    |                    |                    |                    |
|-------------------|-----------|--------------------|--------------------|--------------------|--------------------|
| L x W [mm]        |           | 3.2x2.5(32)<1210>  |                    |                    |                    |
| Rated Volt. [Vdc] |           | 100(2A)            | 50(1H)             | 25(1E)             | 16(1C)             |
| TC                |           | X7R(R7)            |                    |                    |                    |
| Capacitance       | Tolerance | Part Number        |                    |                    |                    |
| 1.0μF(105)        | ±10%(K)   |                    | GCM32ER71H105KA37L |                    |                    |
| 2.2μF(225)        | ±10%(K)   | GCM32DR72A225KA64L |                    |                    |                    |
| 4.7μF(475)        | ±10%(K)   |                    | GCM32ER71H475KA55L | GCM32DR71E475KA55L |                    |
| 10μF(106)         | ±10%(K)   |                    |                    | GCM32ER71E106KA57L | GCM32DR71C106KA37L |
| 22μF(226)         | ±20%(M)   |                    |                    |                    | GCM32ER71C226ME19L |

|                   |           |                    |                    |  |  |
|-------------------|-----------|--------------------|--------------------|--|--|
| L x W [mm]        |           | 3.2x2.5(32)<1210>  |                    |  |  |
| Rated Volt. [Vdc] |           | 10(1A)             | 6.3(0J)            |  |  |
| TC                |           | X7R(R7)            |                    |  |  |
| Capacitance       | Tolerance | Part Number        |                    |  |  |
| 22μF(226)         | ±20%(M)   | GCM32ER71A226ME12L |                    |  |  |
| 47μF(476)         | ±20%(M)   |                    | GCM32ER70J476ME19L |  |  |

The part numbering code is shown in ( ) and Unit is shown in [ ]. < >: EIA [inch] Code



# Specifications and Test Methods

Continued from the preceding page.

| No.  | AEC-Q200 Test Item                                       | Specifications   |  | AEC-Q200 Test Method   |   |
|------|--|--|--|--|---|
|      |  | Temperature Compensating Type  | High Dielectric Type   |  |   |
| 7    | Operational Life   | The measured and observed characteristics should satisfy the specifications in the following table.                              |  | Apply 200% of the rated voltage for 1000±12 hours at 125±3°C. Let sit for 24±2 hours at room temperature, then measure. *2<br>The charge/discharge current is less than 50mA.<br>• Initial measurement for high dielectric constant type.<br>Apply 200% of the rated DC voltage for one hour at the maximum operating temperature ±3°C. Remove and let sit for 24±2 hours at room temperature. Perform initial measurement. *2 |   |
|      | Appearance   | No marking defects   |  |  |   |
|      | Capacitance Change                                       | Within ±3.0% or ±0.30pF (Whichever is larger)  | Within ±12.5%  |  |   |
|      | Q/D.F.   | 30pFmin.: Q≥350<br>10pF and over, 30pF and below:<br>Q≥275+ $\frac{C}{10}$<br>10pFmax.: Q≥200+10C<br>C: Nominal Capacitance (pF) | W.V.: 25Vmin.: 0.035 max.<br>W.V.: 16V: 0.05 max.                      |  |   |
| I.R. | More than 1,000MΩ or 50Ω · F (Whichever is smaller) *1   |  |  |  |   |
| 8    | External Visual  | No defects or abnormalities  |  | Visual inspection  |   |
| 9    | Physical Dimension                                       | Within the specified dimensions  |  | Using calipers   |   |
| 10   | Resistance to Solvents                                   | Appearance   | No marking defects   |  | Per MIL-STD-202 Method 215<br>Solvent 1: 1 part (by volume) of isopropyl alcohol<br>3 parts (by volume) of mineral spirits<br>Solvent 2: Terpene defluxer<br>Solvent 3: 42 parts (by volume) of water<br>1 part (by volume) of propylene glycol monomethyl ether<br>1 part (by volume) of monoethanolamine  |
|      |  | Capacitance Change   | Within the specified tolerance   |  |   |
|      |  | Q/D.F.   | 30pFmin.: Q≥1000<br>30pFmax.: Q≥400+20C<br>C: Nominal Capacitance (pF) | W.V.: 25Vmin.: 0.025 max.<br>W.V.: 16V: 0.035 max.   |   |
|      |  | I.R.   | More than 10,000MΩ or 500Ω · F (Whichever is smaller) *1               |  |   |
| 11   | Mechanical Shock   | Appearance   | No marking defects   |  | Three shocks in each direction should be applied along 3 mutually perpendicular axes of the test specimen (18 shocks). The specified test pulse should be Half-sine and should have a duration: 0.5ms, peak value: 1500g and velocity change: 4.7m/s.   |
|      |  | Capacitance Change   | Within the specified tolerance   |  |   |
|      |  | Q/D.F.   | 30pFmin.: Q≥1000<br>30pFmax.: Q≥400+20C<br>C: Nominal Capacitance (pF) | W.V.: 25Vmin.: 0.025 max.<br>W.V.: 16V: 0.035 max.   |   |
|      |  | I.R.   | More than 10,000MΩ or 500Ω · F (Whichever is smaller) *1               |  |   |
| 12   | Vibration  | Appearance   | No defects or abnormalities  |  | Solder the capacitor to the test jig (glass epoxy board) in the same manner and under the same conditions as (19). The capacitor should be subjected to a simple harmonic motion having a total amplitude of 1.5mm, the frequency being varied uniformly between the approximate limits of 10 and 2000Hz. The frequency range, from 10 to 2000Hz and return to 10Hz, should be traversed in approximately 20 minutes. This motion should be applied for 12 items in each 3 mutually perpendicular directions (total of 36 times). |
|      |  | Capacitance Change   | Within the specified tolerance   |  |   |
|      |  | Q/D.F.   | 30pFmin.: Q≥1000<br>30pFmax.: Q≥400+20C<br>C: Nominal Capacitance (pF) | W.V.: 25Vmin.: 0.025 max.<br>W.V.: 16V: 0.035 max.   |   |
|      |  | I.R.   | More than 10,000MΩ or 500Ω · F (Whichever is smaller) *1               |  |   |
| 13   | Resistance to Soldering Heat                             | The measured and observed characteristics should satisfy the specifications in the following table.                              |  | Immerse the capacitor in a eutectic solder solution at 260±5°C for 10±1 seconds. Let sit at room temperature for 24±2 hours, then measure.<br>• Initial measurement for high dielectric constant type<br>Perform a heat treatment at 150±5°C for one hour and then let sit for 24±2 hours at room temperature.<br>Perform the initial measurement.   |   |
|      | Appearance   | No marking defects   |  |  |   |
|      | Capacitance Change                                       | Within the specified tolerance   |  |  |   |
|      | Q/D.F.   | 30pFmin.: Q≥1000<br>30pFmax.: Q≥400+20C<br>C: Nominal Capacitance (pF)   | W.V.: 25Vmin.: 0.025 max.<br>W.V.: 16V: 0.035 max.                     |  |   |
| I.R. | More than 10,000MΩ or 500Ω · F (Whichever is smaller) *1 |  |  |  |   |

\*1: The figure indicates typical specification. Please refer to individual specifications.

\*2: Some of the parts are applicable in rated voltage x 150%. Please refer to individual specifications.

Continued on the following page. 

# Specifications and Test Methods

Continued from the preceding page.

| No.                      | AEC-Q200 Test Item   | Specifications  |  | AEC-Q200 Test Method  |  |                                   |   |            |             |                       |             |          |          |              |          |          |           |                          |  |  |             |           |         |        |          |           |        |          |             |
|--------------------------|--|---|--|---|--|-----------------------------------|---|------------|-------------|-----------------------|-------------|----------|----------|--------------|----------|----------|-----------|--------------------------|--|--|-------------|-----------|---------|--------|----------|-----------|--------|----------|-------------|
|                          |  | Temperature Compensating Type   | High Dielectric Type   |   |  |                                   |   |            |             |                       |             |          |          |              |          |          |           |                          |  |  |             |           |         |        |          |           |        |          |             |
| 14                       | Thermal Shock  | The measured and observed characteristics should satisfy the specifications in the following table. |  | Fix the capacitor to the supporting jig in the same manner and under the same conditions as (18). Perform the 300 cycles according to the two heat treatments listed in the following table (Maximum transfer time is 20 seconds). Let sit for 24±2 hours at room temperature, then measure. <table border="1" style="margin: 10px auto; border-collapse: collapse;"> <thead> <tr> <th>Step</th> <th>1</th> <th>2</th> </tr> </thead> <tbody> <tr> <td>Temp. (°C)</td> <td>-55+0/-3</td> <td>125+3/-0 (5C, C7, R7)</td> </tr> <tr> <td>Time (min.)</td> <td>15±3</td> <td>15±3</td> </tr> </tbody> </table> <ul style="list-style-type: none"> <li>Initial measurement for high dielectric constant type</li> </ul> Perform a heat treatment at 150 <sup>+0</sup> / <sub>-0</sub> °C for one hour and then let sit for 24±2 hours at room temperature. Perform the initial measurement. | Step   | 1                                 | 2 | Temp. (°C) | -55+0/-3    | 125+3/-0 (5C, C7, R7) | Time (min.) | 15±3     | 15±3     |              |          |          |           |                          |  |  |             |           |         |        |          |           |        |          |             |
|                          |  | Step  | 1  |   | 2  |                                   |   |            |             |                       |             |          |          |              |          |          |           |                          |  |  |             |           |         |        |          |           |        |          |             |
|                          |  | Temp. (°C)  | -55+0/-3   |   | 125+3/-0 (5C, C7, R7)  |                                   |   |            |             |                       |             |          |          |              |          |          |           |                          |  |  |             |           |         |        |          |           |        |          |             |
|                          |  | Time (min.)   | 15±3   |   | 15±3   |                                   |   |            |             |                       |             |          |          |              |          |          |           |                          |  |  |             |           |         |        |          |           |        |          |             |
| Appearance               | No marking defects   |   |  |   |  |                                   |   |            |             |                       |             |          |          |              |          |          |           |                          |  |  |             |           |         |        |          |           |        |          |             |
| Capacitance Change       | Within ±2.5% or ±0.25pF (Whichever is larger)  | Within ±10.0%   |  |   |  |                                   |   |            |             |                       |             |          |          |              |          |          |           |                          |  |  |             |           |         |        |          |           |        |          |             |
| Q/D.F.                   | 30pF min.: Q≥1000<br>30pF max.: Q≥400+20C<br>C: Nominal Capacitance (pF)                   | W.V.: 25Vmin.: 0.025 max.<br>W.V.: 16V: 0.035 max. *1   |  |   |  |                                   |   |            |             |                       |             |          |          |              |          |          |           |                          |  |  |             |           |         |        |          |           |        |          |             |
| I.R.                     | More than 10,000MΩ or 500Ω · F (Whichever is smaller) *1                                   |   |  |   |  |                                   |   |            |             |                       |             |          |          |              |          |          |           |                          |  |  |             |           |         |        |          |           |        |          |             |
| 15                       | ESD  | Appearance  | No marking defects   |   | Per AEC-Q200-002   |                                   |   |            |             |                       |             |          |          |              |          |          |           |                          |  |  |             |           |         |        |          |           |        |          |             |
|                          |  | Capacitance Change  | Within the specified tolerance   |   |  |                                   |   |            |             |                       |             |          |          |              |          |          |           |                          |  |  |             |           |         |        |          |           |        |          |             |
|                          |  | Q/D.F.  | 30pF min.: Q≥1000<br>30pF max.: Q≥400+20C<br>C: Nominal Capacitance (pF)   | W.V.: 25Vmin.: 0.025 max.<br>W.V.: 16V: 0.035 max. *1   |  |                                   |   |            |             |                       |             |          |          |              |          |          |           |                          |  |  |             |           |         |        |          |           |        |          |             |
|                          |  | I.R.  | More than 10,000MΩ or 500Ω · F (Whichever is smaller) *1   |   |  |                                   |   |            |             |                       |             |          |          |              |          |          |           |                          |  |  |             |           |         |        |          |           |        |          |             |
| 16                       | Solderability  | 95% of the terminations is to be soldered evenly and continuously.                                  |  | (a) Preheat at 155°C for 4 hours. After preheating, immerse the capacitor in a solution of ethanol (JIS-K-8101) and rosin (JIS-K-5902) (25% rosin in weight proportion). Immerse in eutectic solder solution for 5+0/-0.5 seconds at 235±5°C.   |  |                                   |   |            |             |                       |             |          |          |              |          |          |           |                          |  |  |             |           |         |        |          |           |        |          |             |
|                          |  |   |  | (b) Should be placed into steam aging for 8 hours±15 minutes. After preheating, immerse the capacitor in a solution of ethanol (JIS-K-8101) and rosin (JIS-K-5902) (25% rosin in weight proportion). Immerse in eutectic solder solution for 5+0/-0.5 seconds at 235±5°C.   |  |                                   |   |            |             |                       |             |          |          |              |          |          |           |                          |  |  |             |           |         |        |          |           |        |          |             |
|                          |  |   |  | (c) Should be placed into steam aging for 8 hours±15 minutes. After preheating, immerse the capacitor in a solution of ethanol (JIS-K-8101) and rosin (JIS-K-5902) (25% rosin in weight proportion). Immerse in eutectic solder solution for 120 ±5 seconds at 260±5°C.   |  |                                   |   |            |             |                       |             |          |          |              |          |          |           |                          |  |  |             |           |         |        |          |           |        |          |             |
| 17                       | Electrical Characterization  | Appearance  | No defects or abnormalities  |   | Visual inspection.   |                                   |   |            |             |                       |             |          |          |              |          |          |           |                          |  |  |             |           |         |        |          |           |        |          |             |
|                          |  | Capacitance Change  | Within the specified tolerance   |   | The capacitance/Q/D.F. should be measured at 25°C at the frequency and voltage shown in the table. <table border="1" style="margin: 5px auto; border-collapse: collapse;"> <thead> <tr> <th colspan="3">(1) Temperature Compensating Type</th> </tr> <tr> <th>Capacitance</th> <th>Frequency</th> <th>Voltage</th> </tr> </thead> <tbody> <tr> <td>C≤1000pF</td> <td>1±0.1MHz</td> <td>0.5 to 5Vrms</td> </tr> <tr> <td>C&gt;1000pF</td> <td>1±0.1kHz</td> <td>1±0.2Vrms</td> </tr> </tbody> </table> <table border="1" style="margin: 5px auto; border-collapse: collapse;"> <thead> <tr> <th colspan="3">(2) High Dielectric Type</th> </tr> <tr> <th>Capacitance</th> <th>Frequency</th> <th>Voltage</th> </tr> </thead> <tbody> <tr> <td>C≤10μF</td> <td>1±0.1kHz</td> <td>1±0.2Vrms</td> </tr> <tr> <td>C&gt;10μF</td> <td>120±24Hz</td> <td>0.5±0.1Vrms</td> </tr> </tbody> </table> | (1) Temperature Compensating Type |   |            | Capacitance | Frequency             | Voltage     | C≤1000pF | 1±0.1MHz | 0.5 to 5Vrms | C>1000pF | 1±0.1kHz | 1±0.2Vrms | (2) High Dielectric Type |  |  | Capacitance | Frequency | Voltage | C≤10μF | 1±0.1kHz | 1±0.2Vrms | C>10μF | 120±24Hz | 0.5±0.1Vrms |
|                          |  | (1) Temperature Compensating Type   |  |   |  |                                   |   |            |             |                       |             |          |          |              |          |          |           |                          |  |  |             |           |         |        |          |           |        |          |             |
|                          |  | Capacitance   | Frequency  | Voltage   |  |                                   |   |            |             |                       |             |          |          |              |          |          |           |                          |  |  |             |           |         |        |          |           |        |          |             |
| C≤1000pF                 | 1±0.1MHz   | 0.5 to 5Vrms  |  |   |  |                                   |   |            |             |                       |             |          |          |              |          |          |           |                          |  |  |             |           |         |        |          |           |        |          |             |
| C>1000pF                 | 1±0.1kHz   | 1±0.2Vrms   |  |   |  |                                   |   |            |             |                       |             |          |          |              |          |          |           |                          |  |  |             |           |         |        |          |           |        |          |             |
| (2) High Dielectric Type |  |   |  |   |  |                                   |   |            |             |                       |             |          |          |              |          |          |           |                          |  |  |             |           |         |        |          |           |        |          |             |
| Capacitance              | Frequency  | Voltage   |  |   |  |                                   |   |            |             |                       |             |          |          |              |          |          |           |                          |  |  |             |           |         |        |          |           |        |          |             |
| C≤10μF                   | 1±0.1kHz   | 1±0.2Vrms   |  |   |  |                                   |   |            |             |                       |             |          |          |              |          |          |           |                          |  |  |             |           |         |        |          |           |        |          |             |
| C>10μF                   | 120±24Hz   | 0.5±0.1Vrms   |  |   |  |                                   |   |            |             |                       |             |          |          |              |          |          |           |                          |  |  |             |           |         |        |          |           |        |          |             |
| Q/D.F.                   | 30pF min.: Q≥1000<br>30pF max.: Q≥400+20C<br>C: Nominal Capacitance (pF)                   | W.V.: 25V min.: 0.025 max.<br>W.V.: 16V: 0.035 max. *1  |  |   |  |                                   |   |            |             |                       |             |          |          |              |          |          |           |                          |  |  |             |           |         |        |          |           |        |          |             |
| I.R.                     | 25°C<br>More than 100,000MΩ or 1,000Ω · F (Whichever is smaller)                           | 25°C<br>More than 10,000MΩ or 500Ω · F (Whichever is smaller)                                       | The insulation resistance should be measured with a DC voltage not exceeding the rated voltage at 25°C and 125°C and within 2 minutes of charging. |   |  |                                   |   |            |             |                       |             |          |          |              |          |          |           |                          |  |  |             |           |         |        |          |           |        |          |             |
|                          | Max. Operating Temperature--125°C<br>More than 10,000MΩ or 100Ω · F (Whichever is smaller) | Max. Operating Temperature--125°C<br>More than 1,000MΩ or 10Ω · F (Whichever is smaller)            |  |   |  |                                   |   |            |             |                       |             |          |          |              |          |          |           |                          |  |  |             |           |         |        |          |           |        |          |             |
|                          | Dielectric Strength  | No failure  |  | No failure should be observed when 250% of the rated voltage is applied between the terminations for 1 to 5 seconds, provided the charge/discharge current is less than 50mA.   |  |                                   |   |            |             |                       |             |          |          |              |          |          |           |                          |  |  |             |           |         |        |          |           |        |          |             |

\*1: The figure indicates typical specification. Please refer to individual specifications.

Continued on the following page.

# Specifications and Test Methods

Continued from the preceding page.

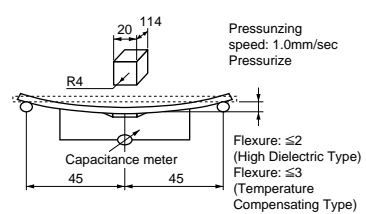
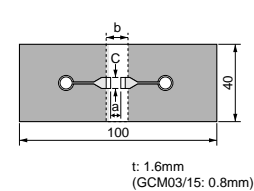
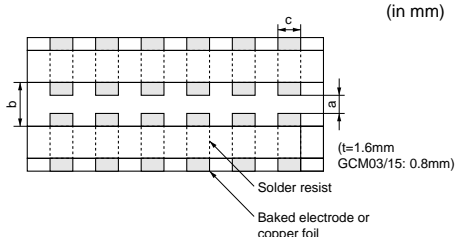
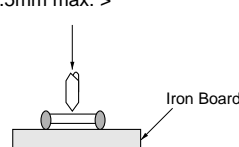
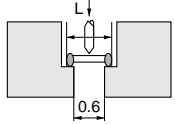
| No.                | AEC-Q200 Test Item   | Specifications  |                      | AEC-Q200 Test Method |  |      |   |   |   |       |     |     |     |       |     |     |     |       |     |     |     |       |     |     |      |       |     |     |     |       |     |     |     |
|--------------------|--|---|----------------------|----------------------|--|------|---|---|---|-------|-----|-----|-----|-------|-----|-----|-----|-------|-----|-----|-----|-------|-----|-----|------|-------|-----|-----|-----|-------|-----|-----|-----|
|                    |  | Temperature Compensating Type   | High Dielectric Type |                      |  |      |   |   |   |       |     |     |     |       |     |     |     |       |     |     |     |       |     |     |      |       |     |     |     |       |     |     |     |
| 18                 | Board Flex   | Appearance  | No marking defects   |                      | Solder the capacitor on the test jig (glass epoxy board) shown in Fig. 1 using a eutectic solder. Then apply a force in the direction shown in Fig. 2 for 5±1sec. The soldering should be done by the reflow method and should be conducted with care so that the soldering is uniform and free of defects such as heat shock. <table border="1" style="margin-top: 10px;"> <thead> <tr> <th>Type</th> <th>a</th> <th>b</th> <th>c</th> </tr> </thead> <tbody> <tr> <td>GCM03</td> <td>0.3</td> <td>0.9</td> <td>0.3</td> </tr> <tr> <td>GCM15</td> <td>0.5</td> <td>1.5</td> <td>0.6</td> </tr> <tr> <td>GCM18</td> <td>0.6</td> <td>2.2</td> <td>0.9</td> </tr> <tr> <td>GCM21</td> <td>0.8</td> <td>3.0</td> <td>1.3</td> </tr> <tr> <td>GCM31</td> <td>2.0</td> <td>4.4</td> <td>1.7</td> </tr> <tr> <td>GCM32</td> <td>2.0</td> <td>4.4</td> <td>2.6</td> </tr> </tbody> </table> <div style="text-align: right; margin-top: 5px;">(in mm)</div>   | Type | a | b | c | GCM03 | 0.3 | 0.9 | 0.3 | GCM15 | 0.5 | 1.5 | 0.6 | GCM18 | 0.6 | 2.2 | 0.9 | GCM21 | 0.8 | 3.0 | 1.3  | GCM31 | 2.0 | 4.4 | 1.7 | GCM32 | 2.0 | 4.4 | 2.6 |
|                    |  | Type  | a                    | b                    |  | c    |   |   |   |       |     |     |     |       |     |     |     |       |     |     |     |       |     |     |      |       |     |     |     |       |     |     |     |
|                    |  | GCM03   | 0.3                  | 0.9                  |  | 0.3  |   |   |   |       |     |     |     |       |     |     |     |       |     |     |     |       |     |     |      |       |     |     |     |       |     |     |     |
|                    |  | GCM15   | 0.5                  | 1.5                  |  | 0.6  |   |   |   |       |     |     |     |       |     |     |     |       |     |     |     |       |     |     |      |       |     |     |     |       |     |     |     |
| GCM18              | 0.6  | 2.2   | 0.9                  |                      |  |      |   |   |   |       |     |     |     |       |     |     |     |       |     |     |     |       |     |     |      |       |     |     |     |       |     |     |     |
| GCM21              | 0.8  | 3.0   | 1.3                  |                      |  |      |   |   |   |       |     |     |     |       |     |     |     |       |     |     |     |       |     |     |      |       |     |     |     |       |     |     |     |
| GCM31              | 2.0  | 4.4   | 1.7                  |                      |  |      |   |   |   |       |     |     |     |       |     |     |     |       |     |     |     |       |     |     |      |       |     |     |     |       |     |     |     |
| GCM32              | 2.0  | 4.4   | 2.6                  |                      |  |      |   |   |   |       |     |     |     |       |     |     |     |       |     |     |     |       |     |     |      |       |     |     |     |       |     |     |     |
| Capacitance Change | Within ±5.0% or ±0.5pF (Whichever is larger)                             | Within ±10.0%   |                      |                      |  |      |   |   |   |       |     |     |     |       |     |     |     |       |     |     |     |       |     |     |      |       |     |     |     |       |     |     |     |
| Q/D.F.             | 30pF min.: Q≥1000<br>30pF max.: Q≥400+20C<br>C: Nominal Capacitance (pF) | W.V.: 25Vmin.: 0.025 max.<br>W.V.: 16V: 0.035 max. *1   |                      |                      |  |      |   |   |   |       |     |     |     |       |     |     |     |       |     |     |     |       |     |     |      |       |     |     |     |       |     |     |     |
| I.R.               | More than 10,000MΩ or 500Ω · F (Whichever is smaller) *1                 |  <p style="text-align: center;">Fig. 1</p>   |                      |                      |  |      |   |   |   |       |     |     |     |       |     |     |     |       |     |     |     |       |     |     |      |       |     |     |     |       |     |     |     |
| 19                 | Terminal Strength  | Appearance  | No marking defects   |                      | Solder the capacitor to the test jig (glass epoxy board) shown in Fig. 3 using a eutectic solder. Then apply *18N force in parallel with the test jig for 60sec. The soldering should be done either with an iron or using the reflow method and should be conducted with care so that the soldering is uniform and free of defects such as heat shock. *2N (GCM03/15) <table border="1" style="margin-top: 10px;"> <thead> <tr> <th>Type</th> <th>a</th> <th>b</th> <th>c</th> </tr> </thead> <tbody> <tr> <td>GCM03</td> <td>0.3</td> <td>0.9</td> <td>0.3</td> </tr> <tr> <td>GCM15</td> <td>0.4</td> <td>1.5</td> <td>0.5</td> </tr> <tr> <td>GCM18</td> <td>1.0</td> <td>3.0</td> <td>1.2</td> </tr> <tr> <td>GCM21</td> <td>1.2</td> <td>4.0</td> <td>1.65</td> </tr> <tr> <td>GCM31</td> <td>2.2</td> <td>5.0</td> <td>2.0</td> </tr> <tr> <td>GCM32</td> <td>2.2</td> <td>5.0</td> <td>2.9</td> </tr> </tbody> </table> <div style="text-align: right; margin-top: 5px;">(in mm)</div>  | Type | a | b | c | GCM03 | 0.3 | 0.9 | 0.3 | GCM15 | 0.4 | 1.5 | 0.5 | GCM18 | 1.0 | 3.0 | 1.2 | GCM21 | 1.2 | 4.0 | 1.65 | GCM31 | 2.2 | 5.0 | 2.0 | GCM32 | 2.2 | 5.0 | 2.9 |
|                    |  | Type  | a                    | b                    |  | c    |   |   |   |       |     |     |     |       |     |     |     |       |     |     |     |       |     |     |      |       |     |     |     |       |     |     |     |
|                    |  | GCM03   | 0.3                  | 0.9                  |  | 0.3  |   |   |   |       |     |     |     |       |     |     |     |       |     |     |     |       |     |     |      |       |     |     |     |       |     |     |     |
|                    |  | GCM15   | 0.4                  | 1.5                  |  | 0.5  |   |   |   |       |     |     |     |       |     |     |     |       |     |     |     |       |     |     |      |       |     |     |     |       |     |     |     |
| GCM18              | 1.0  | 3.0   | 1.2                  |                      |  |      |   |   |   |       |     |     |     |       |     |     |     |       |     |     |     |       |     |     |      |       |     |     |     |       |     |     |     |
| GCM21              | 1.2  | 4.0   | 1.65                 |                      |  |      |   |   |   |       |     |     |     |       |     |     |     |       |     |     |     |       |     |     |      |       |     |     |     |       |     |     |     |
| GCM31              | 2.2  | 5.0   | 2.0                  |                      |  |      |   |   |   |       |     |     |     |       |     |     |     |       |     |     |     |       |     |     |      |       |     |     |     |       |     |     |     |
| GCM32              | 2.2  | 5.0   | 2.9                  |                      |  |      |   |   |   |       |     |     |     |       |     |     |     |       |     |     |     |       |     |     |      |       |     |     |     |       |     |     |     |
| Capacitance Change | Within the specified tolerance   |   |                      |                      |  |      |   |   |   |       |     |     |     |       |     |     |     |       |     |     |     |       |     |     |      |       |     |     |     |       |     |     |     |
| Q/D.F.             | 30pF min.: Q≥1000<br>30pF max.: Q≥400+20C<br>C: Nominal Capacitance (pF) | W.V.: 25Vmin.: 0.025 max.<br>W.V.: 16V: 0.035 max. *1   |                      |                      |  |      |   |   |   |       |     |     |     |       |     |     |     |       |     |     |     |       |     |     |      |       |     |     |     |       |     |     |     |
| I.R.               | More than 10,000MΩ or 500Ω · F (Whichever is smaller) *1                 |   |                      |                      |  |      |   |   |   |       |     |     |     |       |     |     |     |       |     |     |     |       |     |     |      |       |     |     |     |       |     |     |     |
| 20                 | Beam Load Test   | The chip endure following force.<br>< Chip L dimension: 2.5mm max. ><br>Chip thickness > 0.5mm rank: 20N<br>Chip thickness ≤ 0.5mm rank: 8N<br>< Chip L dimension: 3.2mm min. ><br>Chip thickness < 1.25mm rank: 15N<br>Chip thickness ≥ 1.25mm rank: 54.5N |                      |                      | Place the capacitor in the beam load fixture as Fig. 4. Apply a force.<br>< Chip Length: 2.5mm max. > <br>< Chip Length: 3.2mm min. >    |      |   |   |   |       |     |     |     |       |     |     |     |       |     |     |     |       |     |     |      |       |     |     |     |       |     |     |     |
|                    |  |   |                      |                      | Fig. 4   |      |   |   |   |       |     |     |     |       |     |     |     |       |     |     |     |       |     |     |      |       |     |     |     |       |     |     |     |

\*1: The figure indicates typical specification. Please refer to individual specifications.

Continued on the following page.



# Specifications and Test Methods

Continued from the preceding page.

| No.                     | AEC-Q200 Test Item   |                    | Specifications                           |  | AEC-Q200 Test Method   |      |                  |   |      |   |       |   |      |   |       |   |      |
|-------------------------|--|--------------------|--|--|--|------|------------------|---|------|---|-------|---|------|---|-------|---|------|
|                         |  |                    | Temperature Compensating Type            | High Dielectric Type   |  |      |                  |   |      |   |       |   |      |   |       |   |      |
| 21                      | Capacitance Temperature Characteristics                                    | Capacitance Change | Within the specified tolerance (Table A) | C7: Within ±22% (-55°C to +125°C)<br>R7: Within ±15% (-55°C to +125°C) | The capacitance change should be measured after 5 min. at each specified temperature stage.<br>(1) Temperature Compensating Type<br>The temperature coefficient is determined using the capacitance measured in step 3 as a reference. When cycling the temperature sequentially from step1 through 5 (ΔC: +25°C to +125°C; other temp. coeffs.: +25°C to +85°C) the capacitance should be within the specified tolerance for the temperature coefficient and capacitance change as shown in Table A. The capacitance drift is calculated by dividing the differences between the maximum and minimum measured values in steps 1, 3 and 5 by the capacitance value in step 3. <table border="1" style="margin: 10px 0;"> <thead> <tr> <th>Step</th> <th>Temperature (°C)</th> </tr> </thead> <tbody> <tr> <td>1</td> <td>25±2</td> </tr> <tr> <td>2</td> <td>-55±3</td> </tr> <tr> <td>3</td> <td>25±2</td> </tr> <tr> <td>4</td> <td>125±3</td> </tr> <tr> <td>5</td> <td>25±2</td> </tr> </tbody> </table> (2) High Dielectric Constant Type<br>The ranges of capacitance change compared with the above 25°C value over the temperature ranges shown in the table should be within the specified ranges.<br>- Initial measurement for high dielectric constant type.<br>- Perform a heat treatment at 150+0/-10°C for one hour and then set for 24±2 hours at room temperature.<br>Perform the initial measurement. | Step | Temperature (°C) | 1 | 25±2 | 2 | -55±3 | 3 | 25±2 | 4 | 125±3 | 5 | 25±2 |
|                         |  | Step               | Temperature (°C)                         |  |  |      |                  |   |      |   |       |   |      |   |       |   |      |
|                         |  | 1                  | 25±2                                     |  |  |      |                  |   |      |   |       |   |      |   |       |   |      |
| 2                       | -55±3  |                    |  |  |  |      |                  |   |      |   |       |   |      |   |       |   |      |
| 3                       | 25±2   |                    |  |  |  |      |                  |   |      |   |       |   |      |   |       |   |      |
| 4                       | 125±3  |                    |  |  |  |      |                  |   |      |   |       |   |      |   |       |   |      |
| 5                       | 25±2   |                    |  |  |  |      |                  |   |      |   |       |   |      |   |       |   |      |
| Temperature Coefficient | Within the specified tolerance (Table A)                                   |                    |  |  |  |      |                  |   |      |   |       |   |      |   |       |   |      |
| Capacitance Drift       | Within ±0.2% or ±0.05 pF (Whichever is larger)<br>* Do not apply to 1X/25V |                    |  |  |  |      |                  |   |      |   |       |   |      |   |       |   |      |

\*1: The figure indicates typical specification. Please refer to individual specifications.

Table A

| Char. | Nominal Values (ppm/°C) Note1 | Capacitance Change from 25°C (%) |       |      |       |      |       |
|-------|-------------------------------|----------------------------------|-------|------|-------|------|-------|
|       |                               | -55                              |       | -30  |       | -10  |       |
|       |                               | Max.                             | Min.  | Max. | Min.  | Max. | Min.  |
| 5C    | 0±30                          | 0.58                             | -0.24 | 0.40 | -0.17 | 0.25 | -0.11 |

Note 1: Nominal values denote the temperature coefficient within a range of 25°C to 125°C (for 5C).

■ Minimum Quantity Guide

| Part Number  | Dimensions (mm) |      |             | Quantity (pcs.)                 |                                    |                                 |                                    |                                |                               |
|--------------|-----------------|------|-------------|---------------------------------|------------------------------------|---------------------------------|------------------------------------|--------------------------------|-------------------------------|
|              |                 |      |             | ø180mm reel                     |                                    | ø330mm reel                     |                                    | Bulk Case<br>Packaging Code: C | Bulk Bag<br>Packaging Code: B |
|              | L               | W    | T           | Paper Tape<br>Packaging Code: D | Embossed Tape<br>Packaging Code: L | Paper Tape<br>Packaging Code: J | Embossed Tape<br>Packaging Code: K |                                |                               |
| <b>GCM03</b> | 0.6             | 0.3  | 0.3         | 15,000                          | -                                  | 50,000                          | -                                  | -                              | 1,000                         |
| <b>GCM15</b> | 1.0             | 0.5  | 0.5         | 10,000                          | -                                  | 50,000                          | -                                  | 50,000                         | 1,000                         |
| <b>GCM18</b> | 1.6             | 0.8  | 0.8         | 4,000                           | -                                  | 10,000                          | -                                  | 15,000 <sup>1)</sup>           | 1,000                         |
| <b>GCM21</b> | 2.0             | 1.25 | 0.6         | 4,000                           | -                                  | 10,000                          | -                                  | 10,000                         | 1,000                         |
|              |                 |      | 0.85        | 4,000                           | -                                  | 10,000                          | -                                  | -                              | 1,000                         |
|              |                 |      | 1.25        | -                               | 3,000                              | -                               | 10,000                             | 5,000 <sup>1)</sup>            | 1,000                         |
| <b>GCM31</b> | 3.2             | 1.6  | 0.85        | 4,000                           | -                                  | 10,000                          | -                                  | -                              | 1,000                         |
|              |                 |      | 1.15        | -                               | 3,000                              | -                               | 10,000                             | -                              | 1,000                         |
|              |                 |      | 1.6         | -                               | 2,000                              | -                               | 6,000                              | -                              | 1,000                         |
| <b>GCM32</b> | 3.2             | 2.5  | 1.15        | -                               | 3,000                              | -                               | 10,000                             | -                              | 1,000                         |
|              |                 |      | 1.35        | -                               | 2,000                              | -                               | 8,000                              | -                              | 1,000                         |
|              |                 |      | 1.6         | -                               | 2,000                              | -                               | 6,000                              | -                              | 1,000                         |
|              |                 |      | 1.8/2.0/2.5 | -                               | 1,000                              | -                               | 4,000                              | -                              | 1,000                         |

1) There are parts number without bulk case.

■ Tape Carrier Packaging

1. Dimensions of Reel

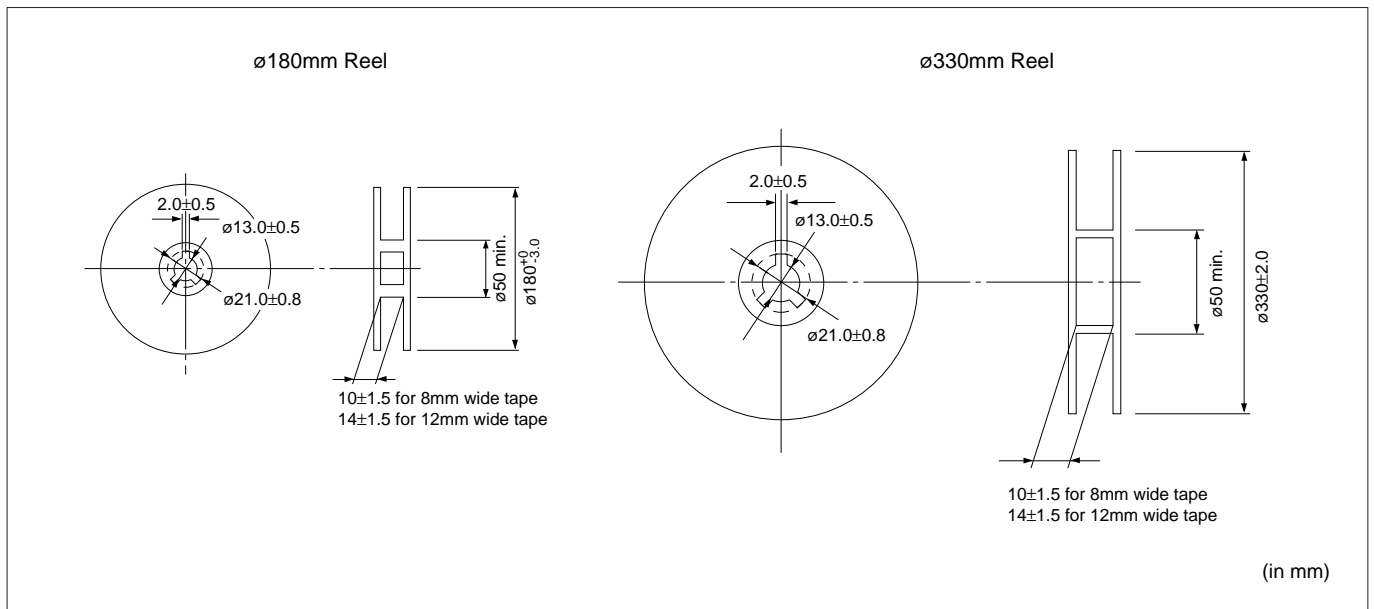

Continued on the following page.

# Package

Continued from the preceding page.

## 2. Dimensions of Paper Tape

8mm width 4mm pitch Tape

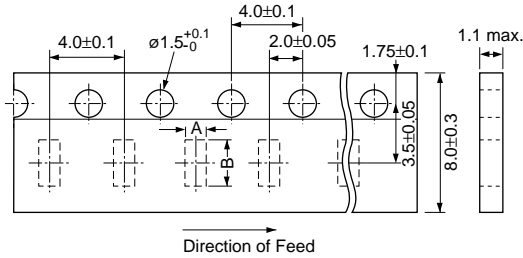

8mm width 2mm pitch Tape

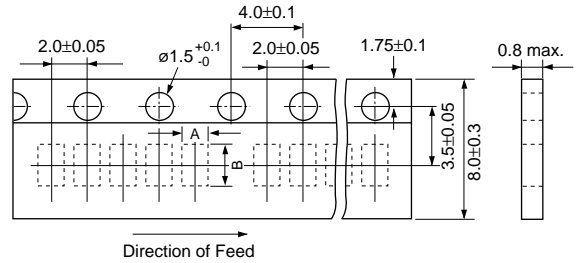

| Part Number                | A         | B        |
|----------------------------|-----------|----------|
| <b>GCM18</b>               | 1.05±0.1  | 1.85±0.1 |
| <b>GCM21</b><br>(T≤0.85mm) | 1.55±0.15 | 2.3±0.15 |
| <b>GCM31</b><br>(T≤0.85mm) | 2.0±0.2   | 3.6±0.2  |
| <b>GCM32</b><br>(T=0.85mm) | 2.8±0.2   | 3.6±0.2  |

| Part Number  | A*   | B*   |
|--------------|------|------|
| <b>GCM03</b> | 0.37 | 0.67 |
| <b>GCM15</b> | 0.65 | 1.15 |

\*Nominal Value

(in mm)

## 3. Dimensions of Embossed Tape

8mm width 4mm pitch Tape

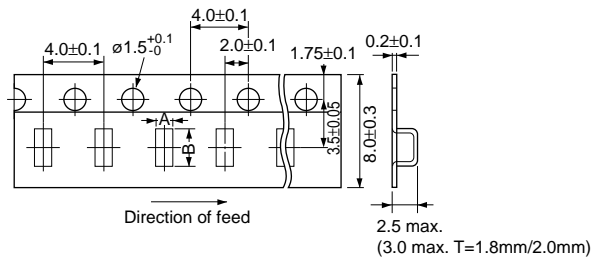

| Part Number                | A        | B        |
|----------------------------|----------|----------|
| <b>GCM21</b><br>(T=1.25mm) | 1.45±0.2 | 2.25±0.2 |
| <b>GCM31</b><br>(T≥1.15mm) | 1.9±0.2  | 3.5±0.2  |
| <b>GCM32</b><br>(T≥1.15mm) | 2.8±0.2  | 3.5±0.2  |

\*Nominal Value

(in mm)

Continued on the following page. ↗

Continued from the preceding page.

#### 4. Taping Method

- (1) Tapes for capacitors are wound clockwise. The sprocket holes are to the right as the tape is pulled toward the user.
- (2) Part of the leader and part of the empty tape should be attached to the end of the tape as follows.
- (3) The top tape and base tape are not attached at the end of the tape for a minimum of 5 pitches.
- (4) Missing capacitors number within 0.1% of the number per reel or 1 pc, whichever is greater, and are not continuous.
- (5) The top tape and bottom tape should not protrude beyond the edges of the tape and should not cover sprocket holes.
- (6) Cumulative tolerance of sprocket holes, 10 pitches:  $\pm 0.3\text{mm}$ .
- (7) Peeling off force: 0.1 to  $0.6\text{N}^*$  in the direction shown below.

\*GCM03: 0.05 to 0.5N

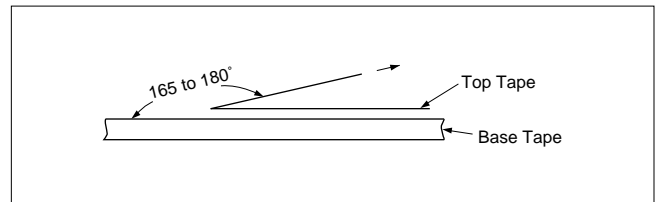
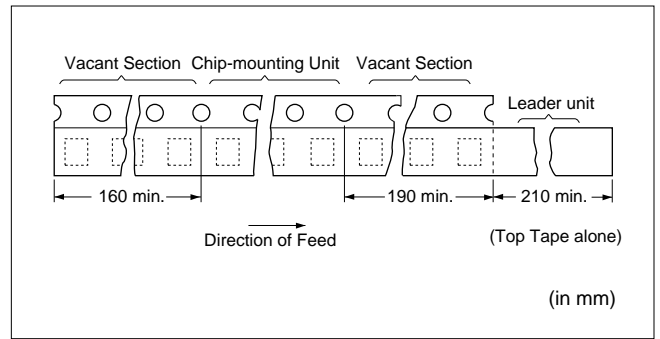

#### ■ Dimensions of Bulk Case Packaging

The bulk case uses antistatic materials. Please contact Murata for details.

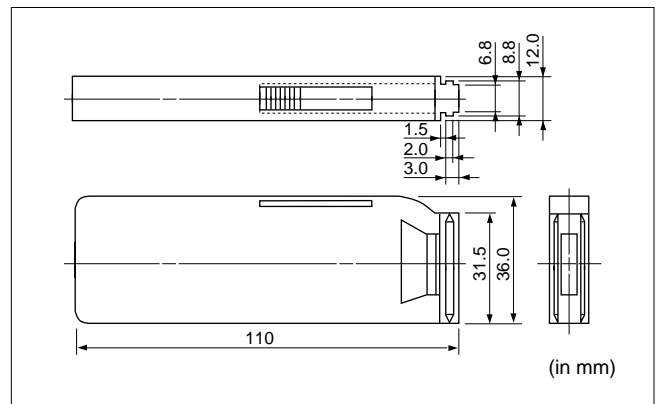

## ⚠ Caution (Storage and Operation Condition)

### ■ Storage and Operation condition

1. The performance of chip monolithic ceramic capacitors may be affected by the storage conditions.
  - 1-1. Store capacitors in the following conditions:  
Temperature of +5°C to +40°C and a Relative Humidity of 20% to 70%.
    - (1) Sunlight, dust, rapid temperature changes, corrosive gas atmosphere or high temperature and humidity conditions during storage may affect the solderability and the packaging performance. Please use product within six months of receipt.
    - (2) Please confirm solderability before using after six months. Store the capacitors without opening the original bag. Even if the storage period is short, do not exceed the specified atmospheric conditions.
  - 1-2. Corrosive gas can react with the termination (external) electrodes or lead wires of capacitors, and result in poor solderability. Do not store the capacitors in an atmosphere consisting of corrosive gas (e.g., hydrogen sulfide, sulfur dioxide, chlorine, ammonia gas, etc.).
  - 1-3. Due to moisture condensation caused by rapid humidity changes, or the photochemical change caused by direct sunlight on the terminal electrodes and/or the resin/epoxy coatings, the solderability and electrical performance may deteriorate. Do not store capacitors under direct sunlight or in high humidity conditions.

**Caution (Rating)**

**Rating**

**1. Temperature Dependent Characteristics**

1. The electrical characteristics of the capacitor can change with temperature.

1-1. For capacitors having larger temperature dependency, the capacitance may change with temperature changes.

The following actions are recommended in order to insure suitable capacitance values.

(1) Select a suitable capacitance for the operating temperature range.

(2) The capacitance may change within the rated temperature.

When you use a high dielectric constant type capacitors in a circuit that needs a tight (narrow) capacitance tolerance. Example: a time constant circuit., please carefully consider the characteristics of these capacitors, such as their aging, voltage, and temperature characteristics. And check capacitors using your actual appliances at the intended environment and operating conditions.

Typical Temperature Characteristics Char. R6(X5R)

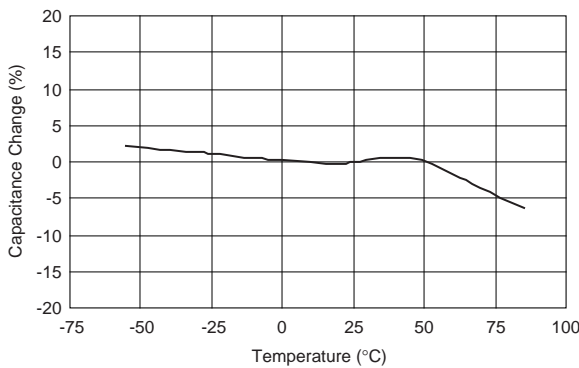

Typical Temperature Characteristics Char. R7(X7R)

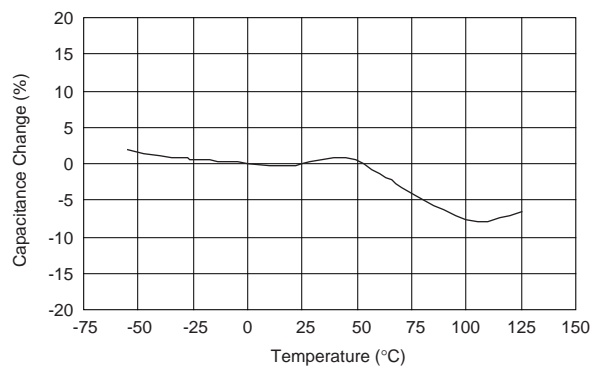

Typical Temperature Characteristics Char. F5(Y5V)

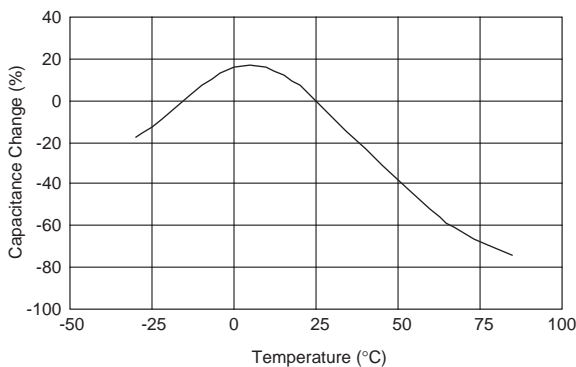

**2. Measurement of Capacitance**

1. Measure capacitance with the voltage and the frequency specified in the product specifications.

1-1. The output voltage of the measuring equipment may decrease when capacitance is high occasionally. Please confirm whether a prescribed measured voltage is impressed to the capacitor.

1-2. The capacitance values of high dielectric constant type capacitors change depending on the AC voltage applied. Please consider the AC voltage characteristics when selecting a capacitor to be used in a AC circuit.

Continued on the following page.

## ⚠ Caution (Rating)

☐ Continued from the preceding page.

### 3. Applied Voltage

1. Do not apply a voltage to the capacitor that exceeds the rated voltage as called-out in the specifications.

1-1. Applied voltage between the terminals of a capacitor shall be less than or equal to the rated voltage.

(1) When AC voltage is superimposed on DC voltage, the zero-to-peak voltage shall not exceed the rated DC voltage.

When AC voltage or pulse voltage is applied, the peak-to-peak voltage shall not exceed the rated DC voltage.

(2) Abnormal voltages (surge voltage, static electricity, pulse voltage, etc.) shall not exceed the rated DC voltage.

#### Typical Voltage Applied to the DC Capacitor

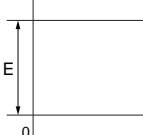
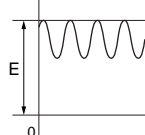
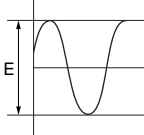
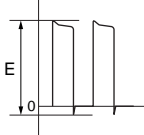
| DC Voltage  | DC Voltage+AC   | AC Voltage   | Pulse Voltage   |
|---|---|--|---|
|  |  |  |  |

(E: Maximum possible applied voltage.)

1-2. Influence of overvoltage

Overvoltage that is applied to the capacitor may result in an electrical short circuit caused by the breakdown of the internal dielectric layers .

The time duration until breakdown depends on the applied voltage and the ambient temperature.

### 4. Applied Voltage and Self-heating Temperature

1. When the capacitor is used in a high-frequency voltage, pulse voltage, application, be sure to take into account self-heating may be caused by resistant factors of the capacitor.

1-1. The load should be contained to the level such that when measuring at atmospheric temperature of 25°C, the product's self-heating remains below 20°C and surface temperature of the capacitor in the actual circuit remains within the maximum operating temperature.

Continued on the following page. ☐

**Caution (Rating)**

Continued from the preceding page.

**5. DC Voltage and AC Voltage Characteristic**

1. The capacitance value of a high dielectric constant type capacitor changes depending on the DC voltage applied. Please consider the DC voltage characteristics when a capacitor is selected for use in a DC circuit.

1-1. The capacitance of ceramic capacitors may change sharply depending on the applied voltage. (See figure)

Please confirm the following in order to secure the capacitance.

- (1) Whether the capacitance change caused by the applied voltage is within the range allowed or not.
- (2) In the DC voltage characteristics, the rate of capacitance change becomes larger as voltage increases. Even if the applied voltage is below the rated voltage. When a high dielectric constant type capacitor is in a circuit that needs a tight (narrow) capacitance tolerance. Example: a time constant circuit., please carefully consider the characteristics of these capacitors, such as their aging, voltage, and temperature characteristics. And check capacitors using your actual appliances at the intended environment and operating conditions.

2. The capacitance values of high dielectric constant type capacitors change depending on the AC voltage applied. Please consider the AC voltage characteristics when selecting a capacitor to be used in a AC circuit.

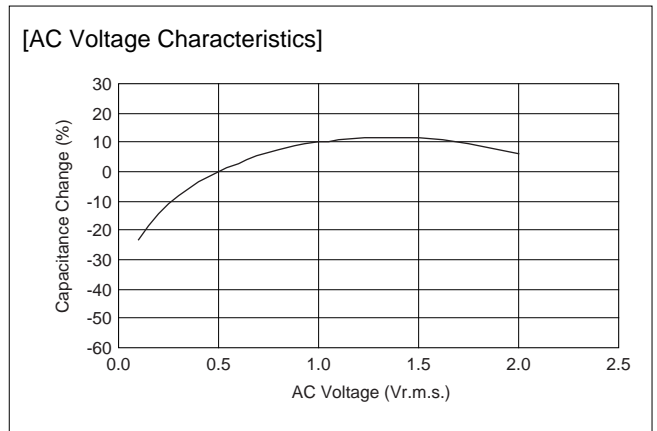
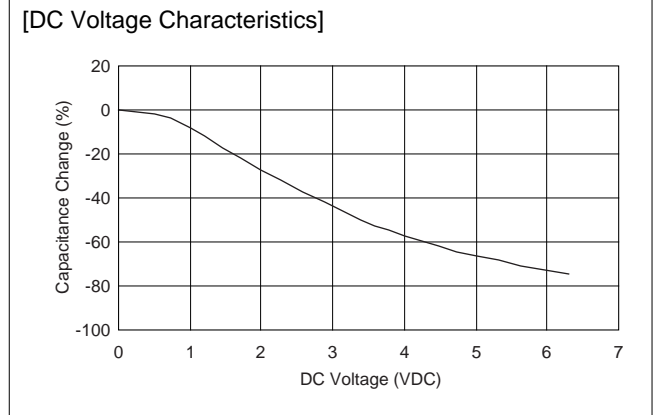

**6. Capacitance Aging**

1. The high dielectric constant type capacitors have the characteristic in which the capacitance value decreases with passage of time.

When you use a high dielectric constant type capacitors in a circuit that needs a tight (narrow) capacitance tolerance. Example: a time constant circuit., please carefully consider the characteristics of these capacitors, such as their aging, voltage, and temperature characteristics. And check capacitors using your actual appliances at the intended environment and operating conditions.

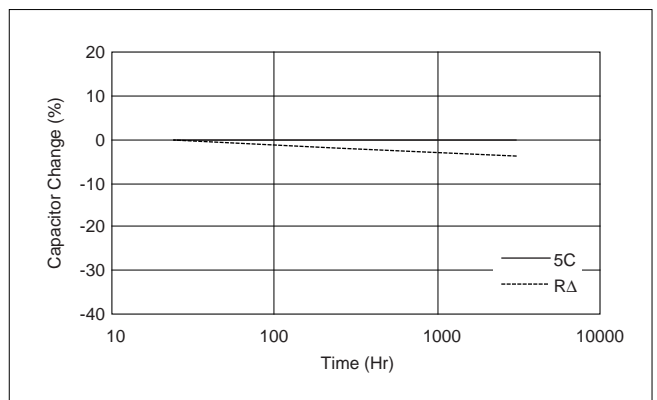

Continued on the following page. ↗



## ⚠ Caution (Rating)

☒ Continued from the preceding page.

### 7. Vibration and Shock

1. The capacitors mechanical stress (vibration and shock) shall be specified for the use environment.  
Please confirm the kind of vibration and/or shock, its condition, and any generation of resonance.  
Please mount the capacitor so as not to generate resonance, and do not allow any impact on the terminals.
2. Mechanical shock due to falling may cause damage or a crack in the dielectric material of the capacitor.  
Do not use a fallen capacitor because the quality and reliability may be deteriorated.
3. When printed circuit boards are piled up or handled, the corners of another printed circuit board should not be allowed to hit the capacitor in order to avoid a crack or other damage to the capacitor.

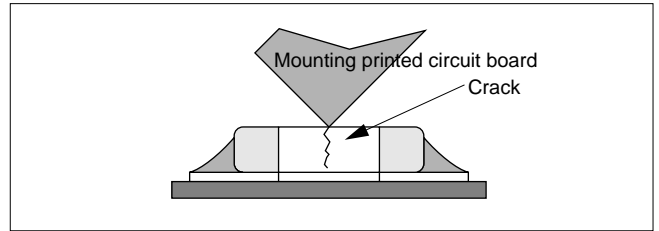
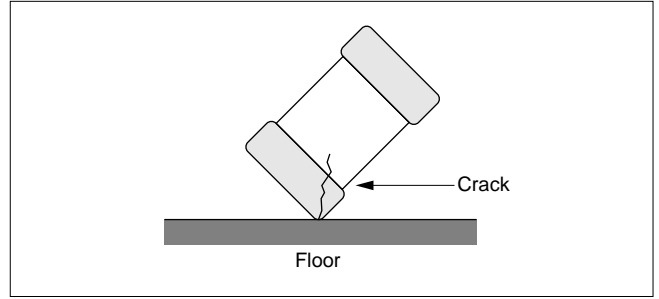

## ⚠ Caution (Soldering and Mounting)

1

### ■ Soldering and Mounting

#### 1. Mounting Position

1. Confirm the best mounting position and direction that minimizes the stress imposed on the capacitor during flexing or bending the printed circuit board.
- 1-1. Choose a mounting position that minimizes the stress imposed on the chip during flexing or bending of the board.

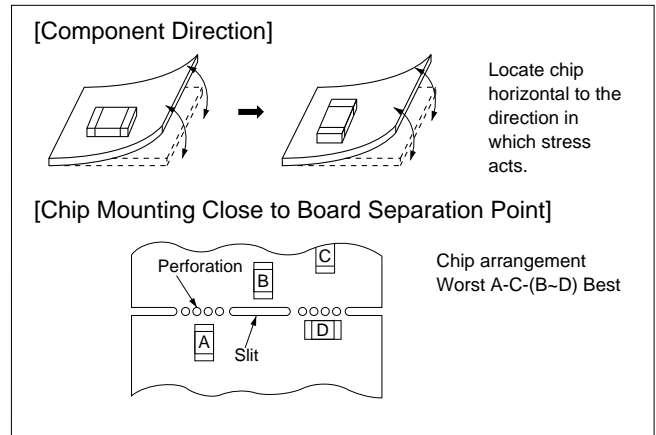

#### 2. Information before Mounting

1. Do not re-use capacitors that were removed from the equipment.
2. Confirm capacitance characteristics under actual applied voltage.
3. Confirm the mechanical stress under actual process and equipment use.
4. Confirm the rated capacitance, rated voltage and other electrical characteristics before assembly.

5. Prior to use, confirm the Solderability for the capacitors that were in long-term storage.
6. Prior to measuring capacitance, carry out a heat treatment for capacitors that were in long-term storage.
7. The use of Sn-Zn based solder will deteriorate the reliability of the MLCC.  
Please contact our sales representative or product engineers on the use of Sn-Zn based solder in advance.

#### 3. Maintenance of the Mounting (pick and place) Machine

1. Make sure that the following excessive forces are not applied to the capacitors.
  - 1-1. In mounting the capacitors on the printed circuit board, any bending force against them shall be kept to a minimum to prevent them from any bending damage or cracking. Please take into account the following precautions and recommendations for use in your process.
    - (1) Adjust the lowest position of the pickup nozzle so as not to bend the printed circuit board.
    - (2) Adjust the nozzle pressure within a static load of 1N to 3N during mounting.
2. Dirt particles and dust accumulated between the suction nozzle and the cylinder inner wall prevent the nozzle from moving smoothly. This imposes greater force upon the chip during mounting, causing cracked chips. Also the locating claw, when worn out, imposes uneven forces on the chip when positioning, causing cracked chips. The suction nozzle and the locating claw must be maintained, checked and replaced periodically.

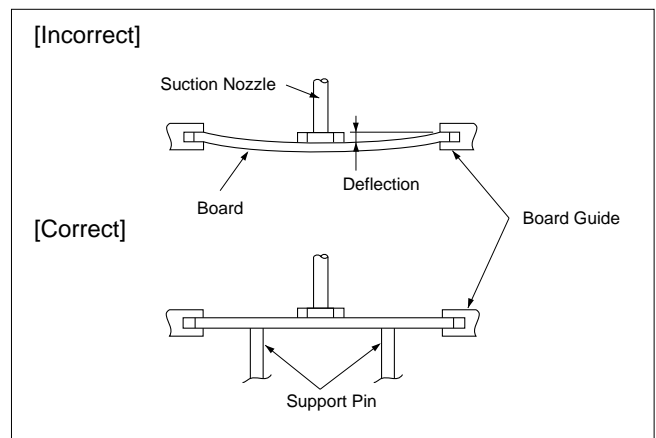

Continued on the following page. ↗

## ⚠ Caution (Soldering and Mounting)

☐ Continued from the preceding page.

### 4-1. Reflow Soldering

- When sudden heat is applied to the components, the mechanical strength of the components will decrease because a sudden temperature change causes deformation inside the components. In order to prevent mechanical damage to the components, preheating is required for both the components and the PCB board. Preheating conditions are shown in table 1. It is required to keep the temperature differential between the solder and the components surface ( $\Delta T$ ) as small as possible.
- Solderability of Tin plating termination chips might be deteriorated when a low temperature soldering profile where the peak solder temperature is below the melting point of Tin is used. Please confirm the Solderability of Tin plated termination chips before use.
- When components are immersed in solvent after mounting, be sure to maintain the temperature difference ( $\Delta T$ ) between the component and the solvent within the range shown in the table 1.

Table 1

| Part Number       | Temperature Differential          |
|-------------------|-----------------------------------|
| GRM03/15/18/21/31 | $\Delta T \leq 190^\circ\text{C}$ |
| GCM32             | $\Delta T \leq 130^\circ\text{C}$ |

#### Recommended Conditions

|                  | Pb-Sn Solder    |              | Lead Free Solder      |
|------------------|-----------------|--------------|-----------------------|
|                  | Infrared Reflow | Vapor Reflow |                       |
| Peak Temperature | 230 to 250°C    | 230 to 240°C | 240 to 260°C          |
| Atmosphere       | Air             | Air          | Air or N <sub>2</sub> |

Pb-Sn Solder: Sn-37Pb

Lead Free Solder: Sn-3.0Ag-0.5Cu

### 4. Optimum Solder Amount for Reflow Soldering

- Overly thick application of solder paste results in a excessive solder fillet height. This makes the chip more susceptible to mechanical and thermal stress on the board and may cause the chips to crack.
- Too little solder paste results in a lack of adhesive strength on the outer electrode, which may result in chips breaking loose from the PCB.
- Make sure the solder has been applied smoothly to the end surface to a height of 0.2mm\* min.

#### Inverting the PCB

Make sure not to impose any abnormal mechanical shocks to the PCB.

#### [Standard Conditions for Reflow Soldering]

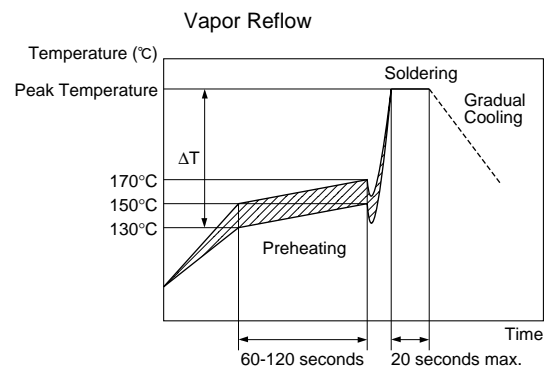
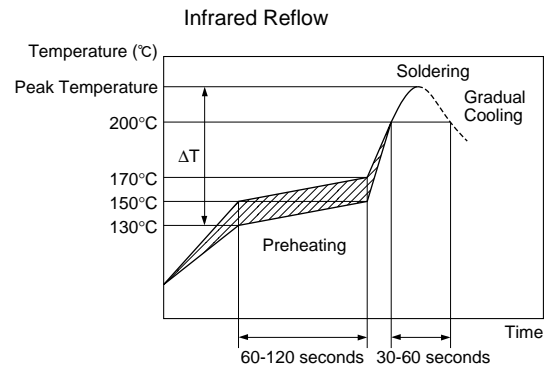

#### [Allowable Reflow Soldering Temperature and Time]

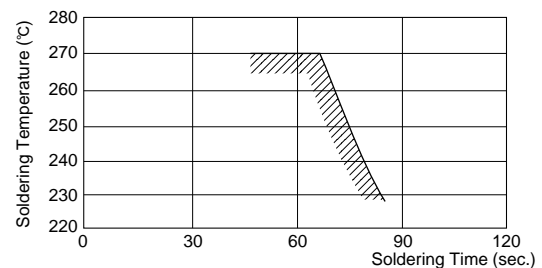

In case of repeated soldering, the accumulated soldering time must be within the range shown above.

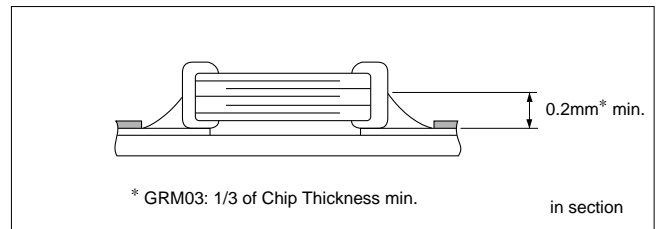

Continued on the following page. ☞

**Caution (Soldering and Mounting)**

Continued from the preceding page.

**4-2. Flow Soldering**

- When sudden heat is applied to the components, the mechanical strength of the components will decrease because a sudden temperature change causes deformation inside the components. In order to prevent mechanical damage in the components, preheating should be required for both of the components and the PCB board.  
Preheating conditions are shown in table 2. It is required to keep temperature differential between the solder and the components surface ( $\Delta T$ ) as small as possible.
- Excessively long soldering time or high soldering temperature can result in leaching of the outer electrodes, causing poor adhesion or a reduction in capacitance value due to loss of contact between electrodes and end termination.
- When components are immersed in solvent after mounting, be sure to maintain the temperature difference ( $\Delta T$ ) between the component and solvent within the range shown in the table 2.
- Do not apply flow soldering to chips not listed in table 2.

Table 2

| Part Number        | Temperature Differential          |
|--------------------|-----------------------------------|
| <b>GCM18/21/31</b> | $\Delta T \leq 150^\circ\text{C}$ |

**Recommended Conditions**

|                             | Pb-Sn Solder | Lead Free Solder |
|-----------------------------|--------------|------------------|
| Preheating Peak Temperature | 90 to 110°C  | 100 to 120°C     |
| Soldering Peak Temperature  | 240 to 250°C | 250 to 260°C     |
| Atmosphere                  | Air          | N <sub>2</sub>   |

Pb-Sn Solder: Sn-37Pb

Lead Free Solder: Sn-3.0Ag-0.5Cu

**5. Optimum Solder Amount for Flow Soldering**

- The top of the solder fillet should be lower than the thickness of components. If the solder amount is excessive, the risk of cracking is higher during board bending or any other stressful condition.

**[Standard Conditions for Flow Soldering]**

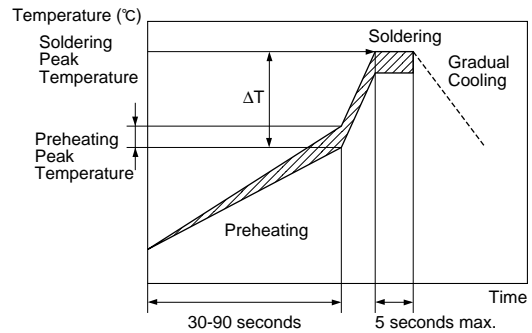

**[Allowable Flow Soldering Temperature and Time]**

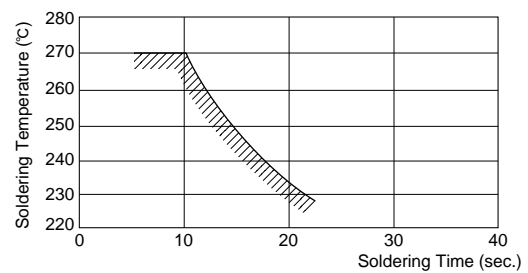

In case of repeated soldering, the accumulated soldering time must be within the range shown above.

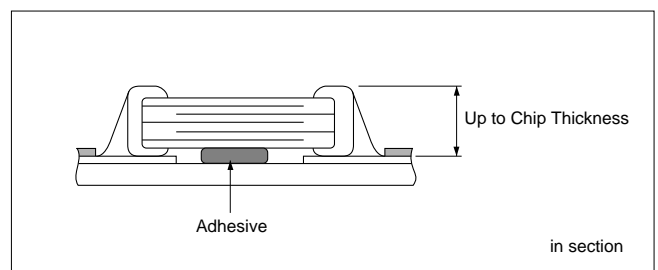

Continued on the following page. ↗

## ⚠ Caution (Soldering and Mounting)

☞ Continued from the preceding page.

### 4-3. Correction with a Soldering Iron

1. When sudden heat is applied to the components when using a soldering iron, the mechanical strength of the components will decrease because the extreme temperature change can cause deformations inside the components. In order to prevent mechanical damage to the components, preheating is required for both the components and the PCB board. Preheating conditions, (The "Temperature of the Soldering Iron Tip", "Preheating Temperature", "Temperature Differential" between the iron tip and the components and the PCB), should be within the conditions of table 3. It is required to keep the temperature differential between the soldering iron and the component surfaces ( $\Delta T$ ) as small as possible.
2. After soldering, do not allow the component/PCB to rapidly cool down.
3. The operating time for the re-working should be as short as possible. When re-working time is too long, it may cause solder leaching, and that will cause a reduction in the adhesive strength of the terminations.
4. Optimum Solder amount when re-working with a Soldering Iron
  - 4-1. In case of sizes smaller than 0603, (GCM03/15/18), the top of the solder fillet should be lower than 2/3's of the thickness of the component or 0.5mm whichever is smaller. In case of 0805 and larger sizes, (GCM21/31/32), the top of the solder fillet should be lower than 2/3's of the thickness of the component. If the solder amount is excessive, the risk of cracking is higher during board bending or under any other stressful condition.
  - 4-2. A soldering iron with a tip of  $\phi 3\text{mm}$  or smaller should be used. It is also necessary to keep the soldering iron from touching the components during the re-work.
  - 4-3. Solder wire with  $\phi 0.5\text{mm}$  or smaller is required for soldering.

### 4-4. Leaded Component Insertion

1. If the PCB is flexed when leaded components (such as transformers and ICs) are being mounted, chips may crack and solder joints may break.  
 Before mounting leaded components, support the PCB using backup pins or special jigs to prevent warping.

### 5. Washing

Excessive ultrasonic oscillation during cleaning can cause the PCBs to resonate, resulting in cracked chips or broken solder joints. Take note not to vibrate PCBs.

Table 3

| Part Number              | Temperature of Soldering Iron Tip | Preheating Temperature | Temperature Differential ( $\Delta T$ ) | Atmosphere |
|--------------------------|-----------------------------------|------------------------|---|------------|
| <b>GCM03/15/18/21/31</b> | 350°C max.                        | 150°C min.             | $\Delta T \leq 190^\circ\text{C}$       | Air        |
| <b>GCM32</b>             | 280°C max.                        | 150°C min.             | $\Delta T \leq 130^\circ\text{C}$       | Air        |

\*Applicable for both Pb-Sn and Lead Free Solder.  
 Pb-Sn Solder: Sn-37Pb  
 Lead Free Solder: Sn-3.0Ag-0.5Cu

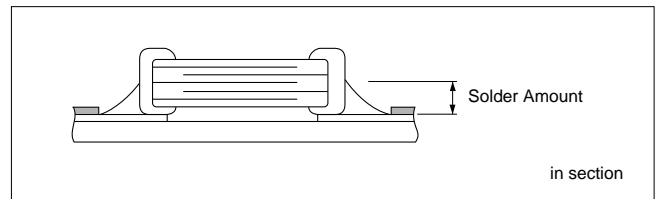

Continued on the following page. ☞

## ⚠ Caution (Soldering and Mounting)

☐ Continued from the preceding page.

### 6. Electrical Test on Printed Circuit Board

1. Confirm position of the support pin or specific jig, when inspecting the electrical performance of a capacitor after mounting on the printed circuit board.

1-1. Avoid bending printed circuit board by the pressure of a test pin, etc.

The thrusting force of the test probe can flex the PCB, resulting in cracked chips or open solder joints. Provide support pins on the back side of the PCB to prevent warping or flexing.

1-2. Avoid vibration of the board by shock when a test pin contacts a printed circuit board.

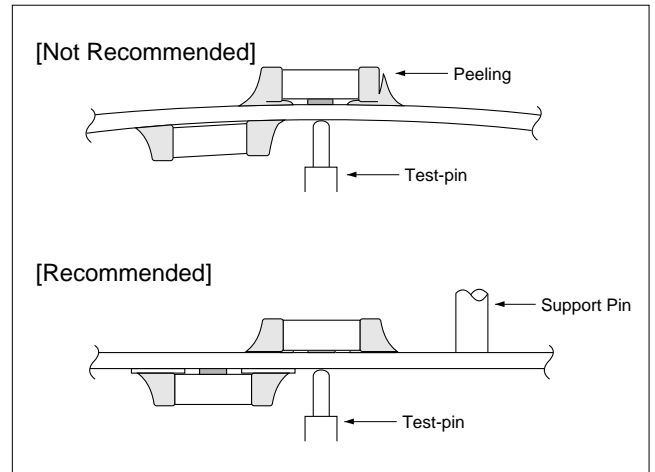

### 7. Printed Circuit Board Cropping

1. After mounting a capacitor on a printed circuit board, do not apply any stress to the capacitor that is caused by bending or twisting the board.

1-1. In cropping the board, the stress as shown right may cause the capacitor to crack.

Try not to apply this type of stress to a capacitor.

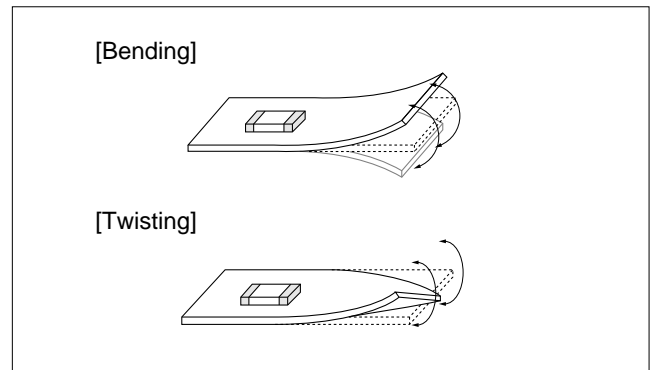

2. Check of the cropping method for the printed circuit board in advance.

2-1. Printed circuit board cropping shall be carried out by using a jig or an apparatus to prevent the mechanical stress which can occur to the board.

(1) Example of a suitable jig

Recommended example: the board should be pushed as close to the near the cropping jig as possible and from the back side of board in order to minimize the compressive stress applied to capacitor.

Not recommended example\* when the board is pushed at a point far from the cropping jig and from the front side of board as below, the capacitor may form a crack caused by the tensile stress applied to capacitor.

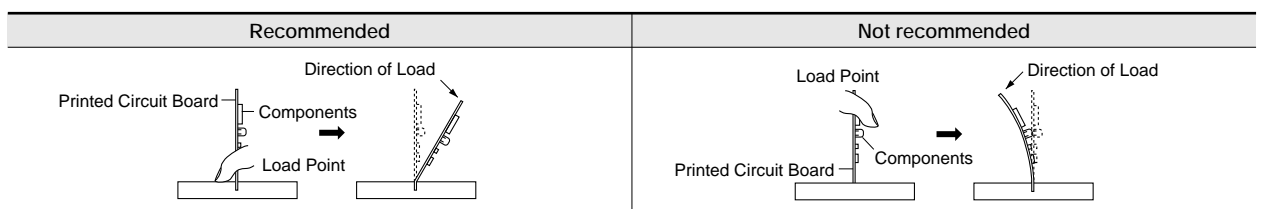
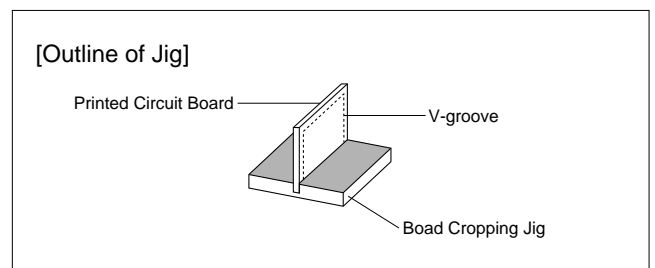

Continued on the following page. ☐

## ⚠ Caution (Soldering and Mounting)

☑ Continued from the preceding page.

### (2) Example of a suitable machine

An outline of a printed circuit board cropping machine is shown as follows. Along the lines with the V-grooves on printed circuit board, the top and bottom blades are aligned to one another when cropping the board.

The misalignment of the position between top and bottom blades may cause the capacitor to crack.

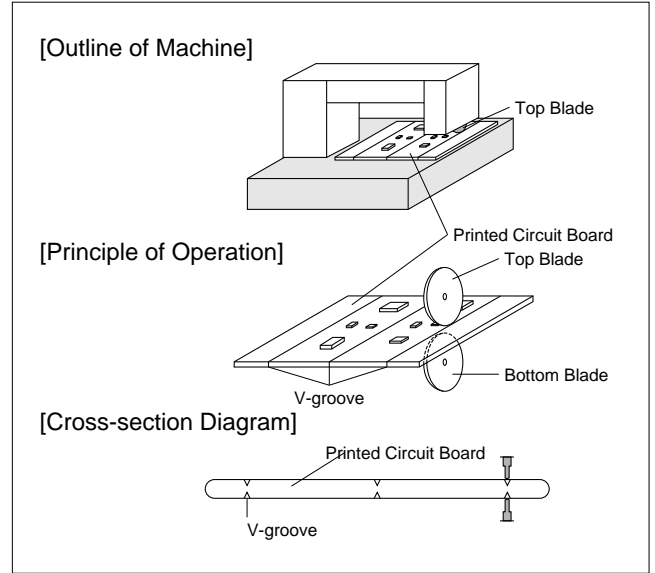

| Recommended                          | Not Recommended                      |                                      |                                      |
|--------------------------------------|--------------------------------------|--------------------------------------|--------------------------------------|
|                                      | Top-bottom Misalignment              | Left-right Misalignment              | Front-rear Misalignment              |
| <p>Top Blade</p> <p>Bottom Blade</p> | <p>Top Blade</p> <p>Bottom Blade</p> | <p>Top Blade</p> <p>Bottom Blade</p> | <p>Top Blade</p> <p>Bottom Blade</p> |

## ■ Others

### 1. Under Operation of Equipment

- 1-1. Do not touch a capacitor directly with bare hands during operation in order to avoid the danger of a electric shock.
- 1-2. Do not allow the terminals of a capacitor to come in contact with any conductive objects (short-circuit). Do not expose a capacitor to a conductive liquid, inducing any acid or alkali solutions.
- 1-3. Confirm the environment in which the equipment will operation is under the specified conditions. Do not use the equipment under the following environment.
  - (1) Being spattered with water or oil.
  - (2) Being exposed to direct sunlight.
  - (3) Being exposed to Ozone, ultraviolet rays or radiation.
  - (4) Being exposed to toxic gas (e.g., hydrogen sulfide, sulfur dioxide, chlorine, ammonia gas, etc.)
  - (5) Any vibrations or mechanical shocks exceeding the specified limits.
  - (6) Moisture condensing environments.
- 1-4. Use damp proof countermeasures if using under any conditions that can cause condensation.

### 2. Others

- 2-1. In an Emergency
  - (1) If the equipment should generate smoke, fire or smell, immediately turn off or unplug the equipment.

If the equipment is not turned off or unplugged, the hazards may be worsened by supplying continuous power.

- (2) In this type of situation, do not allow face and hands to come in contact with the capacitor or burns may be caused by the capacitors high temperature.

### 2-2. Disposal of Waste

When capacitors are disposed, they must be burned or buried by the industrial waste vender with the appropriate licenses.

### 2-3. Circuit Design

GRM, GCM, GMA/D, LLL/A/M, ERB, GQM, GJM, GNM Series capacitors in this catalog are not safety certified products.

### 2-4. Remarks

Failure to follow the cautions may result, worst case, in a short circuit and smoking when the product is used.

The above notices are for standard applications and conditions. Contact us when the products are used in special mounting conditions.

Select optimum conditions for operation as they determine the reliability of the product after assembly. The data herein are given in typical values, not guaranteed ratings.



## Notice (Rating)

### ■ Rating

#### 1. Operating Temperature

1. The operating temperature limit depends on the capacitor.

- 1-1. Do not apply temperatures exceeding the upper operating temperature.

It is necessary to select a capacitor with a suitable rated temperature which will cover the operating temperature range.

Also it is necessary to consider the temperature distribution in equipment and the seasonal temperature variable factor.

- 1-2. Consider the self-heating of the capacitor

The surface temperature of the capacitor shall be the upper operating temperature or less when including the self-heating factors.

#### 2. Atmosphere Surroundings (gaseous and liquid)

1. Restriction on the operating environment of capacitors.

- 1-1. The capacitor, when used in the above, unsuitable, operating environments may deteriorate due to the corrosion of the terminations and the penetration of moisture into the capacitor.

- 1-2. The same phenomenon as the above may occur when the electrodes or terminals of the capacitor are subject to moisture condensation.

- 1-3. The deterioration of characteristics and insulation resistance due to the oxidization or corrosion of terminal electrodes may result in breakdown when the capacitor is exposed to corrosive or volatile gases or solvents for long periods of time.

#### 3. Piezo-electric Phenomenon

1. When using high dielectric constant type capacitors in AC or pulse circuits, the capacitor itself vibrates at specific frequencies and noise may be generated. Moreover, when the mechanical vibration or shock is added to capacitor, noise may occur.

# Notice (Soldering and Mounting)

## ■ Soldering and Mounting

### 1. PCB Design

#### 1. Notice for Pattern Forms

- 1-1. Unlike leaded components, chip components are susceptible to flexing stresses since they are mounted directly on the substrate. They are also more sensitive to mechanical and thermal stresses than leaded components. Excess solder fillet height can multiply these stresses and cause chip cracking. When designing substrates, take land patterns and dimensions into consideration to eliminate the possibility of excess solder fillet height.
- 1-2. It is possible for the chip to crack by the expansion and shrinkage of a metal board. Please contact us if you want to use our ceramic capacitors on a metal board such as Aluminum.

### Pattern Forms

|   | Prohibited | Correct |
|---|------------|---------|
| Placing Close to Chassis                          |            |         |
| Placing of Chip Components and Leaded Components  |            |         |
| Placing of Leaded Components after Chip Component |            |         |
| Lateral Mounting                                  |            |         |

Continued on the following page.

## Notice (Soldering and Mounting)

Continued from the preceding page.

### 2. Land Dimensions

- 2-1. Chip capacitor can be cracked due to the stress of PCB bending / etc if the land area is larger than needed and has an excess amount of solder. Please refer to the land dimensions in table 1 for flow soldering, table 2 for reflow soldering. Please confirm the suitable land dimension by evaluating of the actual SET / PCB.

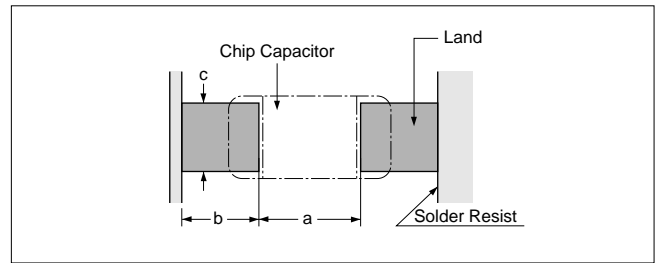

Table 1 Flow Soldering Method

| Part Number | Dimensions | Chip (L×W) | a          | b          | c          |
|-------------|------------|------------|------------|------------|------------|
| GCM18       |            | 1.6×0.8    | 0.6 to 1.0 | 0.8 to 0.9 | 0.6 to 0.8 |
| GCM21       |            | 2.0×1.25   | 1.0 to 1.2 | 0.9 to 1.0 | 0.8 to 1.1 |
| GCM31       |            | 3.2×1.6    | 2.2 to 2.6 | 1.0 to 1.1 | 1.0 to 1.4 |

(in mm)

Table 2 Reflow Soldering Method

| Part Number | Dimensions | Chip (L×W) | a          | b            | c          |
|-------------|------------|------------|------------|--------------|------------|
| GCM03       |            | 0.6×0.3    | 0.2 to 0.3 | 0.2 to 0.35  | 0.2 to 0.4 |
| GCM15       |            | 1.0×0.5    | 0.3 to 0.5 | 0.35 to 0.45 | 0.4 to 0.6 |
| GCM18       |            | 1.6×0.8    | 0.6 to 0.8 | 0.6 to 0.7   | 0.6 to 0.8 |
| GCM21       |            | 2.0×1.25   | 1.0 to 1.2 | 0.6 to 0.7   | 0.8 to 1.1 |
| GCM31       |            | 3.2×1.6    | 2.2 to 2.4 | 0.8 to 0.9   | 1.0 to 1.4 |
| GCM32       |            | 3.2×2.5    | 2.0 to 2.4 | 1.0 to 1.2   | 1.8 to 2.3 |

(in mm)

### 2. Adhesive Application

- Thin or insufficient adhesive can cause the chips to loosen or become disconnected during flow soldering. The amount of adhesive must be more than dimension c, shown in the drawing at right, to obtain the correct bonding strength. The chip's electrode thickness and land thickness must also be taken into consideration.
- Low viscosity adhesive can cause chips to slip after mounting. The adhesive must have a viscosity of 5000Pa · s (500ps) min. (at 25°C).

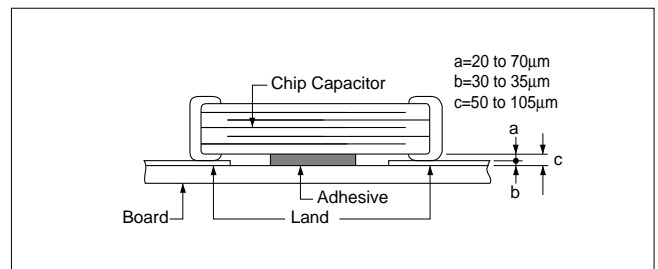

### 3. Adhesive Coverage

| Part Number | Adhesive Coverage* |
|-------------|--------------------|
| GCM18       | 0.05mg min.        |
| GCM21       | 0.1mg min.         |
| GCM31       | 0.15mg min.        |

\*Nominal Value

### 3. Adhesive Curing

- Insufficient curing of the adhesive can cause chips to disconnect during flow soldering and causes deterioration in the insulation resistance between the outer electrodes due to moisture absorption. Control curing temperature and time in order to prevent insufficient hardening.

Continued on the following page. ↗

## Notice (Soldering and Mounting)

☐ Continued from the preceding page.

### 4. Flux Application

1. An excessive amount of flux generates a large quantity of flux gas, which can cause a deterioration of Solderability. So apply flux thinly and evenly throughout. (A foaming system is generally used for flow soldering).
2. Flux containing too a high percentage of halide may cause corrosion of the outer electrodes unless there is sufficient cleaning. Use flux with a halide content of 0.1% max.

3. Do not use strong acidic flux.
4. Do not use water-soluble flux.  
(\*Water-soluble flux can be defined as non rosin type flux including wash-type flux and non-wash-type flux.)

### 5. Flow Soldering

- Set temperature and time to ensure that leaching of the outer electrode does not exceed 25% of the chip end area as a single chip (full length of the edge A-B-C-D shown right) and 25% of the length A-B shown below as mounted on substrate.

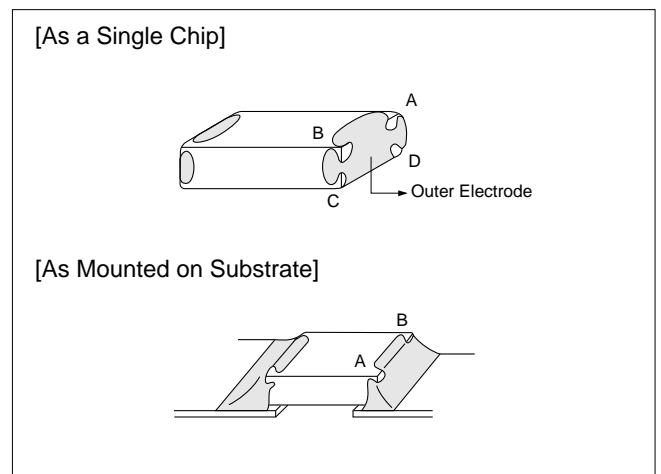

### 6. Washing

1. Please evaluate a capacitor by actual cleaning equipment and condition surely for confirming the quality and select the applicable solvent.
2. Unsuitable cleaning solvent may leave residual flux, other foreign substances, causing deterioration of electrical characteristics and the reliability of the capacitors.

3. Select the proper cleaning conditions.  
3-1. Improper cleaning conditions (excessive or insufficient) may result in the deterioration of the performance of the capacitors.

### 7. Coating

1. A crack may be caused in the capacitor due to the stress of the thermal contraction of the resin during curing process.  
The stress is affected by the amount of resin and curing contraction.  
Select a resin with small curing contraction.  
The difference in the thermal expansion coefficient between a coating resin or a molding resin and capacitor may cause the destruction and deterioration of the capacitor such as a crack or peeling, and lead to the deterioration of insulation resistance or dielectric breakdown.

- Select a resin for which the thermal expansion coefficient is as close to that of capacitor as possible.  
A silicone resin can be used as an under-coating to buffer against the stress.
2. Select a resin that is less hygroscopic.  
Using hygroscopic resins under high humidity conditions may cause the deterioration of the insulation resistance of a capacitor.  
An epoxy resin can be used as a less hygroscopic resin.

## Notice (Others)

### ■ Others

#### 1. Transportation

1. The performance of a capacitor may be affected by the conditions during transportation.

1-1. The capacitors shall be protected against excessive temperature, humidity and mechanical force during transportation.

##### (1) Climatic condition

- low air temperature: -40°C
- change of temperature air/air: -25°C/+25°C
- low air pressure: 30 kPa
- change of air pressure: 6 kPa/min.

##### (2) Mechanical condition

Transportation shall be done in such a way that the boxes are not deformed and forces are not directly passed on to the inner packaging.

1-2. Do not apply excessive vibration, shock, and pressure to the capacitor.

- (1) When excessive mechanical shock or pressure is applied to a capacitor, chipping or cracking may occur in the ceramic body of the capacitor.
- (2) When a sharp edge of an air driver, a soldering iron, tweezers, a chassis, etc. impacts strongly on the surface of capacitor, the capacitor may crack and short-circuit.

1-3. Do not use a capacitor to which excessive shock was applied by dropping, etc.

The capacitor dropped accidentally during processing may be damaged.

# Chip Monolithic Ceramic Capacitors for Automotive



## Medium Voltage for Automotive GCM Series Low Dissipation Factor

### ■ Features

1. The GCM series meet AEC-Q200 requirements.
2. Low-loss and suitable for high frequency circuits
3. Murata's original internal electrode structure realizes high flash-over voltage.
4. A new monolithic structure for small, surface-mountable devices capable of operating at high voltage levels.
5. Sn-plated external electrodes realize good solderability.
6. Use the GCM21/31 type with flow or reflow soldering, and other types with reflow soldering only.

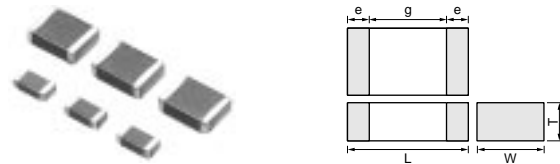

| Part Number | Dimensions (mm) |           |              |        |        |
|-------------|-----------------|-----------|--------------|--------|--------|
|             | L               | W         | T            | e min. | g min. |
| GCM21A      | 2.0 ±0.2        | 1.25 ±0.2 | 1.0 +0,-0.3  | 0.3    | 0.7    |
| GCM21B      |                 |           | 1.25 ±0.2    |        |        |
| GCM31A      | 3.2 ±0.2        | 1.6 ±0.2  | 1.0 +0,-0.3  |        | 1.5    |
| GCM31B      |                 |           | 1.25 +0,-0.3 |        |        |
| GCM32A      | 3.2 ±0.2        | 2.5 ±0.2  | 1.0 +0,-0.3  |        |        |

### ■ Applications

Ideal for use on high frequency pulse circuits such as snubber circuits for DC-DC converters.

| Part Number        | Rated Voltage (V) | TC Code (Standard) | Capacitance (pF) | Length L (mm) | Width W (mm) | Thickness T (mm) | Electrode g min. (mm) | Electrode e (mm) |
|--------------------|-------------------|--------------------|------------------|---------------|--------------|------------------|-----------------------|------------------|
| GCM21A7U2E101JX01D | DC250             | U2J (EIA)          | 100 ±5%          | 2.0           | 1.25         | 1.0              | 0.7                   | 0.3 min.         |
| GCM21A7U2E121JX01D | DC250             | U2J (EIA)          | 120 ±5%          | 2.0           | 1.25         | 1.0              | 0.7                   | 0.3 min.         |
| GCM21A7U2E151JX01D | DC250             | U2J (EIA)          | 150 ±5%          | 2.0           | 1.25         | 1.0              | 0.7                   | 0.3 min.         |
| GCM21A7U2E181JX01D | DC250             | U2J (EIA)          | 180 ±5%          | 2.0           | 1.25         | 1.0              | 0.7                   | 0.3 min.         |
| GCM21A7U2E221JX01D | DC250             | U2J (EIA)          | 220 ±5%          | 2.0           | 1.25         | 1.0              | 0.7                   | 0.3 min.         |
| GCM21A7U2E271JX01D | DC250             | U2J (EIA)          | 270 ±5%          | 2.0           | 1.25         | 1.0              | 0.7                   | 0.3 min.         |
| GCM21A7U2E331JX01D | DC250             | U2J (EIA)          | 330 ±5%          | 2.0           | 1.25         | 1.0              | 0.7                   | 0.3 min.         |
| GCM21A7U2E391JX01D | DC250             | U2J (EIA)          | 390 ±5%          | 2.0           | 1.25         | 1.0              | 0.7                   | 0.3 min.         |
| GCM21A7U2E471JX01D | DC250             | U2J (EIA)          | 470 ±5%          | 2.0           | 1.25         | 1.0              | 0.7                   | 0.3 min.         |
| GCM21A7U2E561JX01D | DC250             | U2J (EIA)          | 560 ±5%          | 2.0           | 1.25         | 1.0              | 0.7                   | 0.3 min.         |
| GCM21A7U2E681JX01D | DC250             | U2J (EIA)          | 680 ±5%          | 2.0           | 1.25         | 1.0              | 0.7                   | 0.3 min.         |
| GCM21A7U2E821JX01D | DC250             | U2J (EIA)          | 820 ±5%          | 2.0           | 1.25         | 1.0              | 0.7                   | 0.3 min.         |
| GCM21A7U2E102JX01D | DC250             | U2J (EIA)          | 1000 ±5%         | 2.0           | 1.25         | 1.0              | 0.7                   | 0.3 min.         |
| GCM21A7U2E122JX01D | DC250             | U2J (EIA)          | 1200 ±5%         | 2.0           | 1.25         | 1.0              | 0.7                   | 0.3 min.         |
| GCM21A7U2E152JX01D | DC250             | U2J (EIA)          | 1500 ±5%         | 2.0           | 1.25         | 1.0              | 0.7                   | 0.3 min.         |
| GCM21A7U2E182JX01D | DC250             | U2J (EIA)          | 1800 ±5%         | 2.0           | 1.25         | 1.0              | 0.7                   | 0.3 min.         |
| GCM21A7U2E222JX01D | DC250             | U2J (EIA)          | 2200 ±5%         | 2.0           | 1.25         | 1.0              | 0.7                   | 0.3 min.         |
| GCM21B7U2E272JX03L | DC250             | U2J (EIA)          | 2700 ±5%         | 2.0           | 1.25         | 1.25             | 0.7                   | 0.3 min.         |
| GCM31A7U2E272JX01D | DC250             | U2J (EIA)          | 2700 ±5%         | 3.2           | 1.6          | 1.0              | 1.5                   | 0.3 min.         |
| GCM21B7U2E332JX03L | DC250             | U2J (EIA)          | 3300 ±5%         | 2.0           | 1.25         | 1.25             | 0.7                   | 0.3 min.         |
| GCM31A7U2E332JX01D | DC250             | U2J (EIA)          | 3300 ±5%         | 3.2           | 1.6          | 1.0              | 1.5                   | 0.3 min.         |
| GCM21B7U2E392JX03L | DC250             | U2J (EIA)          | 3900 ±5%         | 2.0           | 1.25         | 1.25             | 0.7                   | 0.3 min.         |
| GCM31A7U2E392JX01D | DC250             | U2J (EIA)          | 3900 ±5%         | 3.2           | 1.6          | 1.0              | 1.5                   | 0.3 min.         |
| GCM21B7U2E472JX03L | DC250             | U2J (EIA)          | 4700 ±5%         | 2.0           | 1.25         | 1.25             | 0.7                   | 0.3 min.         |
| GCM31A7U2E472JX01D | DC250             | U2J (EIA)          | 4700 ±5%         | 3.2           | 1.6          | 1.0              | 1.5                   | 0.3 min.         |
| GCM21B7U2E562JX03L | DC250             | U2J (EIA)          | 5600 ±5%         | 2.0           | 1.25         | 1.25             | 0.7                   | 0.3 min.         |
| GCM31A7U2E562JX01D | DC250             | U2J (EIA)          | 5600 ±5%         | 3.2           | 1.6          | 1.0              | 1.5                   | 0.3 min.         |
| GCM31B7U2E682JX01L | DC250             | U2J (EIA)          | 6800 ±5%         | 3.2           | 1.6          | 1.25             | 1.5                   | 0.3 min.         |
| GCM31B7U2E822JX01L | DC250             | U2J (EIA)          | 8200 ±5%         | 3.2           | 1.6          | 1.25             | 1.5                   | 0.3 min.         |
| GCM31B7U2E103JX01L | DC250             | U2J (EIA)          | 10000 ±5%        | 3.2           | 1.6          | 1.25             | 1.5                   | 0.3 min.         |
| GCM31A7U2J100JX01D | DC630             | U2J (EIA)          | 10 ±5%           | 3.2           | 1.6          | 1.0              | 1.5                   | 0.3 min.         |
| GCM31A7U2J120JX01D | DC630             | U2J (EIA)          | 12 ±5%           | 3.2           | 1.6          | 1.0              | 1.5                   | 0.3 min.         |
| GCM31A7U2J150JX01D | DC630             | U2J (EIA)          | 15 ±5%           | 3.2           | 1.6          | 1.0              | 1.5                   | 0.3 min.         |

Continued on the following page.

 Continued from the preceding page.

| Part Number        | Rated Voltage (V) | TC Code (Standard) | Capacitance (pF) | Length L (mm) | Width W (mm) | Thickness T (mm) | Electrode g min. (mm) | Electrode e (mm) |
|--------------------|-------------------|--------------------|------------------|---------------|--------------|------------------|-----------------------|------------------|
| GCM31A7U2J180JX01D | DC630             | U2J (EIA)          | 18 ±5%           | 3.2           | 1.6          | 1.0              | 1.5                   | 0.3 min.         |
| GCM31A7U2J220JX01D | DC630             | U2J (EIA)          | 22 ±5%           | 3.2           | 1.6          | 1.0              | 1.5                   | 0.3 min.         |
| GCM31A7U2J270JX01D | DC630             | U2J (EIA)          | 27 ±5%           | 3.2           | 1.6          | 1.0              | 1.5                   | 0.3 min.         |
| GCM31A7U2J330JX01D | DC630             | U2J (EIA)          | 33 ±5%           | 3.2           | 1.6          | 1.0              | 1.5                   | 0.3 min.         |
| GCM31A7U2J390JX01D | DC630             | U2J (EIA)          | 39 ±5%           | 3.2           | 1.6          | 1.0              | 1.5                   | 0.3 min.         |
| GCM31A7U2J470JX01D | DC630             | U2J (EIA)          | 47 ±5%           | 3.2           | 1.6          | 1.0              | 1.5                   | 0.3 min.         |
| GCM31A7U2J560JX01D | DC630             | U2J (EIA)          | 56 ±5%           | 3.2           | 1.6          | 1.0              | 1.5                   | 0.3 min.         |
| GCM31A7U2J680JX01D | DC630             | U2J (EIA)          | 68 ±5%           | 3.2           | 1.6          | 1.0              | 1.5                   | 0.3 min.         |
| GCM31A7U2J820JX01D | DC630             | U2J (EIA)          | 82 ±5%           | 3.2           | 1.6          | 1.0              | 1.5                   | 0.3 min.         |
| GCM31A7U2J101JX01D | DC630             | U2J (EIA)          | 100 ±5%          | 3.2           | 1.6          | 1.0              | 1.5                   | 0.3 min.         |
| GCM31A7U2J121JX01D | DC630             | U2J (EIA)          | 120 ±5%          | 3.2           | 1.6          | 1.0              | 1.5                   | 0.3 min.         |
| GCM31A7U2J151JX01D | DC630             | U2J (EIA)          | 150 ±5%          | 3.2           | 1.6          | 1.0              | 1.5                   | 0.3 min.         |
| GCM31A7U2J181JX01D | DC630             | U2J (EIA)          | 180 ±5%          | 3.2           | 1.6          | 1.0              | 1.5                   | 0.3 min.         |
| GCM31A7U2J221JX01D | DC630             | U2J (EIA)          | 220 ±5%          | 3.2           | 1.6          | 1.0              | 1.5                   | 0.3 min.         |
| GCM31A7U2J271JX01D | DC630             | U2J (EIA)          | 270 ±5%          | 3.2           | 1.6          | 1.0              | 1.5                   | 0.3 min.         |
| GCM31A7U2J331JX01D | DC630             | U2J (EIA)          | 330 ±5%          | 3.2           | 1.6          | 1.0              | 1.5                   | 0.3 min.         |
| GCM31A7U2J391JX01D | DC630             | U2J (EIA)          | 390 ±5%          | 3.2           | 1.6          | 1.0              | 1.5                   | 0.3 min.         |
| GCM31A7U2J471JX01D | DC630             | U2J (EIA)          | 470 ±5%          | 3.2           | 1.6          | 1.0              | 1.5                   | 0.3 min.         |
| GCM31A7U2J561JX01D | DC630             | U2J (EIA)          | 560 ±5%          | 3.2           | 1.6          | 1.0              | 1.5                   | 0.3 min.         |
| GCM31A7U2J681JX01D | DC630             | U2J (EIA)          | 680 ±5%          | 3.2           | 1.6          | 1.0              | 1.5                   | 0.3 min.         |
| GCM31A7U2J821JX01D | DC630             | U2J (EIA)          | 820 ±5%          | 3.2           | 1.6          | 1.0              | 1.5                   | 0.3 min.         |
| GCM31A7U2J102JX01D | DC630             | U2J (EIA)          | 1000 ±5%         | 3.2           | 1.6          | 1.0              | 1.5                   | 0.3 min.         |
| GCM32A7U2J122JX01D | DC630             | U2J (EIA)          | 1200 ±5%         | 3.2           | 2.5          | 1.0              | 1.5                   | 0.3 min.         |
| GCM32A7U2J152JX01D | DC630             | U2J (EIA)          | 1500 ±5%         | 3.2           | 2.5          | 1.0              | 1.5                   | 0.3 min.         |
| GCM32A7U2J182JX01D | DC630             | U2J (EIA)          | 1800 ±5%         | 3.2           | 2.5          | 1.0              | 1.5                   | 0.3 min.         |
| GCM32A7U2J222JX01D | DC630             | U2J (EIA)          | 2200 ±5%         | 3.2           | 2.5          | 1.0              | 1.5                   | 0.3 min.         |

## Specifications and Test Methods

2

| No. | AEC-Q200 Test Item                  | Specifications  | AEC-Q200 Test Method  |   |   |
|-----|-------------------------------------|---|---|---|---|
| 1   | Pre-and Post-Stress Electrical Test | -   |   |   |   |
| 2   | High Temperature Exposure (Storage) | The measured and observed characteristics should satisfy the specifications in the following table. | Sit the capacitor for 1000±12 hours at 150±3°C. Let sit for 24±2 hours at room temperature, then measure.   |   |   |
|     | Appearance                          | No marking defects  |   |   |   |
|     | Capacitance Change                  | Within ±2.5% or ±0.25pF (Whichever is larger)   |   |   |   |
|     | Q                                   | Q≥1000  |   |   |   |
| 3   | Temperature Cycle                   | The measured and observed characteristics should satisfy the specifications in the following table. | Fix the capacitor to the supporting jig in the same manner and under the same conditions as (19). Perform the 1000 cycles according to the 4 heat treatments listed in the following table. Let sit for 24±2 hours at room temperature, then measure. |   |   |
|     | Appearance                          | No marking defects  |   |   |   |
|     | Capacitance Change                  | Within ±2.5% or ±0.25pF (Whichever is larger)   |   |   |   |
|     | Q                                   | Q≥1000  |   |   |   |
| 4   | Destructive Physical Analysis       | No defects or abnormalities   | Per EIA-469   |   |   |
|     | 5                                   | Moisture Resistance   |   | The measured and observed characteristics should satisfy the specifications in the following table. | Apply the 24 hour heat (25 to 65°C) and humidity (80 to 98%) treatment shown below, 10 consecutive times. Let sit for 24±2 hours at room temperature, then measure. |
|     |                                     | Appearance  |   | No marking defects  |   |
|     |                                     | Capacitance Change  |   | Within ±3.0% or ±0.3pF (Whichever is larger)  |   |
| Q   |                                     | Q≥350   |   |   |   |
| 6   | Biased Humidity                     | The measured and observed characteristics should satisfy the specifications in the following table. | Apply the rated voltage and DC1.3+0.2/-0V (add 6.8kΩ resistor) at 85±3°C and 80 to 85% humidity for 1000±12 hours. Remove and let sit for 24±2 hours at room temperature, then measure.<br>The charge/discharge current is less than 50mA.            |   |   |
|     |                                     |   |   | Appearance  | No marking defects  |
|     |                                     |   |   | Capacitance Change  | Within ±3.0% or ±0.3pF (Whichever is larger)  |
|     |                                     |   |   | Q   | Q≥200   |
| 7   | Operational Life                    | The measured and observed characteristics should satisfy the specifications in the following table. | Apply voltage as Table for 1000±12 hours at 125±3°C. Let sit for 24±2 hours at room temperature, then measure.  |   |   |
|     |                                     |   |   | Appearance  | No marking defects  |
|     |                                     |   |   | Capacitance Change  | Within ±3.0% or ±0.3pF (Whichever is larger)  |
|     |                                     |   |   | Q   | Q≥350   |
| 8   | External Visual                     | No defects or abnormalities   | Visual inspection   |   |   |
|     | Physical Dimension                  | Within the specified dimensions   | Using calipers and micrometers  |   |   |

| Step        | 1        | 2          | 3        | 4          |
|-------------|----------|------------|----------|------------|
| Temp. (°C)  | -55+0/-3 | Room Temp. | 125+3/-0 | Room Temp. |
| Time (min.) | 15±3     | 1          | 15±3     | 1          |

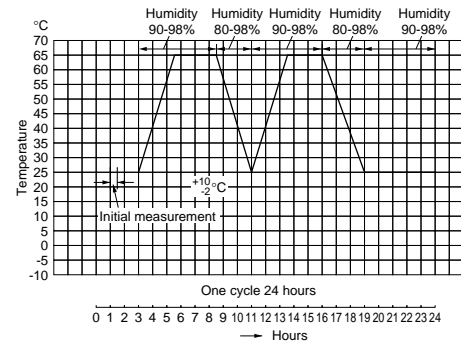

| Rated Voltage | Applied Voltage           |
|---------------|---------------------------|
| DC250V        | 150% of the rated voltage |
| DC630V        | 120% of the rated voltage |

Continued on the following page.



## Specifications and Test Methods

Continued from the preceding page.

| No.                          | AEC-Q200 Test Item           | Specifications  | AEC-Q200 Test Method  |      |   |   |                              |          |          |             |            |            |
|------------------------------|------------------------------|---|---|------|---|---|------------------------------|----------|----------|-------------|------------|------------|
| 10                           | Resistance to Solvents       | Appearance  | No marking defects  |      |   |   |                              |          |          |             |            |            |
|                              |                              | Capacitance Change  | Within the specified tolerance  |      |   |   |                              |          |          |             |            |            |
|                              |                              | Q   | $Q \geq 1000$   |      |   |   |                              |          |          |             |            |            |
|                              |                              | I.R.  | More than 10,000M $\Omega$ or 500M $\Omega \cdot \mu\text{F}$ (Whichever is smaller)  |      |   |   |                              |          |          |             |            |            |
|                              |                              |   | Per MIL-STD-202 Method 215<br>Solvent 1: 1 part (by volume) of isopropyl alcohol<br>3 parts (by volume) of mineral spirits<br>Solvent 2: Terpene defluxer<br>Solvent 3: 42 parts (by volume) of water<br>1 part (by volume) of propylene glycol monomethyl ether<br>1 part (by volume) of monoethanolamine  |      |   |   |                              |          |          |             |            |            |
| 11                           | Mechanical Shock             | Appearance  | No marking defects  |      |   |   |                              |          |          |             |            |            |
|                              |                              | Capacitance Change  | Within the specified tolerance  |      |   |   |                              |          |          |             |            |            |
|                              |                              | Q   | $Q \geq 1000$   |      |   |   |                              |          |          |             |            |            |
|                              |                              | I.R.  | More than 10,000M $\Omega$ or 500M $\Omega \cdot \mu\text{F}$ (Whichever is smaller)  |      |   |   |                              |          |          |             |            |            |
|                              |                              |   | Three shocks in each direction should be applied along 3 mutually perpendicular axes of the test specimen (18 shocks). The specified test pulse should be Half-sine and should have a duration: 0.5ms, peak value: 1500g and velocity change: 4.7m/s.   |      |   |   |                              |          |          |             |            |            |
| 12                           | Vibration                    | Appearance  | No defects or abnormalities   |      |   |   |                              |          |          |             |            |            |
|                              |                              | Capacitance Change  | Within the specified tolerance  |      |   |   |                              |          |          |             |            |            |
|                              |                              | Q   | $Q \geq 1000$   |      |   |   |                              |          |          |             |            |            |
|                              |                              | I.R.  | More than 10,000M $\Omega$ or 500M $\Omega \cdot \mu\text{F}$ (Whichever is smaller)  |      |   |   |                              |          |          |             |            |            |
|                              |                              |   | Solder the capacitor to the test jig (glass epoxy board) in the same manner and under the same conditions as (19). The capacitor should be subjected to a simple harmonic motion having a total amplitude of 1.5mm, the frequency being varied uniformly between the approximate limits of 10 and 2000Hz. The frequency range, from 10 to 2000Hz and return to 10Hz, should be traversed in approximately 20 minutes. This motion should be applied for 12 items in each 3 mutually perpendicular directions (total of 36 times). |      |   |   |                              |          |          |             |            |            |
| 13                           | Resistance to Soldering Heat | The measured and observed characteristics should satisfy the specifications in the following table.   |   |      |   |   |                              |          |          |             |            |            |
|                              | Appearance                   | No marking defects  |   |      |   |   |                              |          |          |             |            |            |
|                              | Capacitance Change           | Within the specified tolerance  |   |      |   |   |                              |          |          |             |            |            |
|                              | Q                            | $Q \geq 1000$   |   |      |   |   |                              |          |          |             |            |            |
|                              |                              |   | Immerse the capacitor in a eutectic solder solution at 260 $\pm$ 5 $^{\circ}\text{C}$ for 10 $\pm$ 1 seconds. Let sit at room temperature for 24 $\pm$ 2 hours, then measure.   |      |   |   |                              |          |          |             |            |            |
| 14                           | Thermal Shock                | The measured and observed characteristics should satisfy the specifications in the following table.   |   |      |   |   |                              |          |          |             |            |            |
|                              |                              | Appearance  | No marking defects  |      |   |   |                              |          |          |             |            |            |
|                              |                              | Capacitance Change  | Within $\pm 2.5\%$ or $\pm 0.25\text{pF}$ (Whichever is larger)   |      |   |   |                              |          |          |             |            |            |
|                              |                              | Q   | $Q \geq 1000$   |      |   |   |                              |          |          |             |            |            |
|                              |                              |   | Fix the capacitor to the supporting jig in the same manner and under the same conditions as (19). Perform the 300 cycles according to the two heat treatments listed in the following table (Maximum transfer time is 20 seconds). Let sit for 24 $\pm$ 2 hours at room temperature, then measure.  |      |   |   |                              |          |          |             |            |            |
|                              |                              |   | <table border="1"> <thead> <tr> <th>Step</th> <th>1</th> <th>2</th> </tr> </thead> <tbody> <tr> <td>Temp. (<math>^{\circ}\text{C}</math>)</td> <td>-55+0/-3</td> <td>125+3/-0</td> </tr> <tr> <td>Time (min.)</td> <td>15<math>\pm</math>3</td> <td>15<math>\pm</math>3</td> </tr> </tbody> </table>  | Step | 1 | 2 | Temp. ( $^{\circ}\text{C}$ ) | -55+0/-3 | 125+3/-0 | Time (min.) | 15 $\pm$ 3 | 15 $\pm$ 3 |
| Step                         | 1                            | 2   |   |      |   |   |                              |          |          |             |            |            |
| Temp. ( $^{\circ}\text{C}$ ) | -55+0/-3                     | 125+3/-0  |   |      |   |   |                              |          |          |             |            |            |
| Time (min.)                  | 15 $\pm$ 3                   | 15 $\pm$ 3  |   |      |   |   |                              |          |          |             |            |            |
| 15                           | ESD                          | Appearance  | No marking defects  |      |   |   |                              |          |          |             |            |            |
|                              |                              | Capacitance Change  | Within the specified tolerance  |      |   |   |                              |          |          |             |            |            |
|                              |                              | Q   | $Q \geq 1000$   |      |   |   |                              |          |          |             |            |            |
|                              |                              | I.R.  | More than 10,000M $\Omega$ or 500M $\Omega \cdot \mu\text{F}$ (Whichever is smaller)  |      |   |   |                              |          |          |             |            |            |
|                              |                              |   | Per AEC-Q200-002  |      |   |   |                              |          |          |             |            |            |
| 16                           | Solderability                | 95% of the terminations is to be soldered evenly and continuously.  |   |      |   |   |                              |          |          |             |            |            |
|                              |                              | (a) Preheat at 155 $^{\circ}\text{C}$ for 4 hours. After preheating, immerse the capacitor in a solution of ethanol (JIS-K-8101) and rosin (JIS-K-5902) (25% rosin in weight proportion). Immerse in eutectic solder solution for 5+0/-0.5 seconds at 235 $\pm$ 5 $^{\circ}\text{C}$ .                  |   |      |   |   |                              |          |          |             |            |            |
|                              |                              | (b) Should be placed into steam aging for 8 hours $\pm$ 15 minutes. After preheating, immerse the capacitor in a solution of ethanol (JIS-K-8101) and rosin (JIS-K-5902) (25% rosin in weight proportion). Immerse in eutectic solder solution for 5+0/-0.5 seconds at 235 $\pm$ 5 $^{\circ}\text{C}$ . |   |      |   |   |                              |          |          |             |            |            |
|                              |                              |   | (c) Should be placed into steam aging for 8 hours $\pm$ 15 minutes. After preheating, immerse the capacitor in a solution of ethanol (JIS-K-8101) and rosin (JIS-K-5902) (25% rosin in weight proportion). Immerse in eutectic solder solution for 120 $\pm$ 5 seconds at 260 $\pm$ 5 $^{\circ}\text{C}$ .  |      |   |   |                              |          |          |             |            |            |

Continued on the following page. 

## Specifications and Test Methods

Continued from the preceding page.

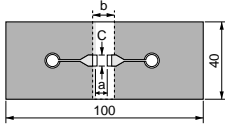
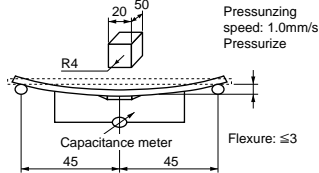
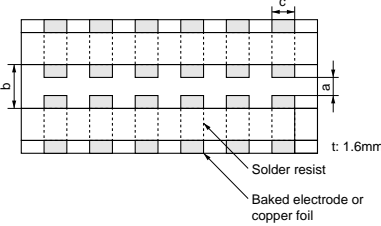
| No.                    | AEC-Q200 Test Item  | Specifications   | AEC-Q200 Test Method  |   |             |                           |         |                           |                       |  |                        |                       |                                |
|------------------------|---|--|---|---|-------------|---------------------------|---------|---------------------------|-----------------------|--|------------------------|-----------------------|--------------------------------|
| 17                     | Electrical Characterization   | Appearance   | No defects or abnormalities   | Visual inspection.  |             |                           |         |                           |                       |  |                        |                       |                                |
|                        |   | Capacitance Change   | Within the specified tolerance  | The capacitance/Q should be measured at 25°C at the frequency and voltage shown in the table.   |             |                           |         |                           |                       |  |                        |                       |                                |
|                        |   | Q  | $Q \geq 1000$   | <table border="1" style="width: 100%; border-collapse: collapse;"> <thead> <tr> <th>Capacitance</th> <th>Frequency</th> <th>Voltage</th> </tr> </thead> <tbody> <tr> <td><math>C &lt; 1000\text{pF}</math></td> <td><math>1 \pm 0.2\text{MHz}</math></td> <td><math>AC 0.5 \text{ to } 5\text{V(r.m.s.)}</math></td> </tr> <tr> <td><math>C \geq 1000\text{pF}</math></td> <td><math>1 \pm 0.2\text{kHz}</math></td> <td><math>AC 1 \pm 0.2\text{V(r.m.s.)}</math></td> </tr> </tbody> </table> | Capacitance | Frequency                 | Voltage | $C < 1000\text{pF}$       | $1 \pm 0.2\text{MHz}$ | $AC 0.5 \text{ to } 5\text{V(r.m.s.)}$ | $C \geq 1000\text{pF}$ | $1 \pm 0.2\text{kHz}$ | $AC 1 \pm 0.2\text{V(r.m.s.)}$ |
|                        |   | Capacitance  | Frequency   | Voltage   |             |                           |         |                           |                       |  |                        |                       |                                |
|                        |   | $C < 1000\text{pF}$  | $1 \pm 0.2\text{MHz}$   | $AC 0.5 \text{ to } 5\text{V(r.m.s.)}$  |             |                           |         |                           |                       |  |                        |                       |                                |
| $C \geq 1000\text{pF}$ | $1 \pm 0.2\text{kHz}$   | $AC 1 \pm 0.2\text{V(r.m.s.)}$   |   |   |             |                           |         |                           |                       |  |                        |                       |                                |
| I.R.                   | 25°C<br>More than 100,000MΩ or 1,000MΩ · μF<br>(Whichever is smaller)<br><br>Max. Operating Temperature...125°C<br>More than 10,000MΩ or 100MΩ · μF<br>(Whichever is smaller) | The insulation resistance should be measured with a DC voltage not exceeding the rated voltage at 25°C and 125°C and within 2 minutes of charging.   |   |   |             |                           |         |                           |                       |  |                        |                       |                                |
| Dielectric Strength    | No failure  | No failure should be observed when voltage in Table is applied between the terminations for 1 to 5 seconds, provided the charge/discharge current is less than 50mA. <table border="1" style="width: 100%; border-collapse: collapse;"> <thead> <tr> <th>Rated Voltage</th> <th>Test Voltage</th> </tr> </thead> <tbody> <tr> <td>DC250V</td> <td>200% of the rated voltage</td> </tr> <tr> <td>DC630V</td> <td>150% of the rated voltage</td> </tr> </tbody> </table> | Rated Voltage   | Test Voltage  | DC250V      | 200% of the rated voltage | DC630V  | 150% of the rated voltage |                       |  |                        |                       |                                |
| Rated Voltage          | Test Voltage  |  |   |   |             |                           |         |                           |                       |  |                        |                       |                                |
| DC250V                 | 200% of the rated voltage   |  |   |   |             |                           |         |                           |                       |  |                        |                       |                                |
| DC630V                 | 150% of the rated voltage   |  |   |   |             |                           |         |                           |                       |  |                        |                       |                                |
| 18                     | Board Flex  | Appearance   | No marking defects  | Solder the capacitor on the test jig (glass epoxy board) shown in Fig. 1 using a eutectic solder. Then apply a force in the direction shown in Fig. 2 for 5±1 seconds. The soldering should be done by the reflow method and should be conducted with care so that the soldering is uniform and free of defects such as heat shock.   |             |                           |         |                           |                       |  |                        |                       |                                |
|                        |   | Capacitance Change   | Within ±5.0% or ±0.5pF (Whichever is larger)  |   |             |                           |         |                           |                       |  |                        |                       |                                |
|                        |   |  <p>Fig. 1</p>  |  <p>Fig. 2</p> |   |             |                           |         |                           |                       |  |                        |                       |                                |
| 19                     | Terminal Strength   | Appearance   | No marking defects  | Solder the capacitor to the test jig (glass epoxy board) shown in Fig. 3 using a eutectic solder. Then apply 18N force in parallel with the test jig for 60 seconds. The soldering should be done by the reflow method and should be conducted with care so that the soldering is uniform and free of defects such as heat shock.   |             |                           |         |                           |                       |  |                        |                       |                                |
|                        |   | Capacitance Change   | Within the specified tolerance  |   |             |                           |         |                           |                       |  |                        |                       |                                |
|                        |   | Q  | $Q \geq 1000$   |   |             |                           |         |                           |                       |  |                        |                       |                                |
|                        |   |  <p>Fig. 3</p>  |   |   |             |                           |         |                           |                       |  |                        |                       |                                |

Continued on the following page.

## Specifications and Test Methods

Continued from the preceding page.

| No. | AEC-Q200 Test Item                      | Specifications  | AEC-Q200 Test Method  |
|-----|---|---|---|
| 20  | Beam Load Test                          | The chip endure following force.<br>< Chip L dimension: 2.5mm max. ><br>Chip thickness > 0.5mm rank: 20N<br>Chip thickness ≤ 0.5mm rank: 8N<br>< Chip L dimension: 3.2mm min. ><br>Chip thickness < 1.25mm rank: 15N<br>Chip thickness ≥ 1.25mm rank: 54.5N | Place the capacitor in the beam load fixture as Fig. 4.<br>Apply a force.<br>< Chip L dimension: 2.5mm max. >   |
|     |   |   | < Chip L dimension: 3.2mm min. >  |
| 21  | Capacitance Temperature Characteristics | Capacitance Change<br>-750±120 ppm/°C<br>(Temp. Range: +25 to +125°C)<br>-750±120, -347 ppm/°C<br>(Temp. Range: -55 to +25°C)   | The capacitance change should be measured after 5 minutes at each specified temperature stage.<br>The temperature coefficient is determined using the capacitance measured in step 3 as a reference. When cycling the temperature sequentially from step1 through 5 the capacitance should be within the specified tolerance for the temperature coefficient. The capacitance drift is calculated by dividing the differences between the maximum and minimum measured values in steps 1, 3 and 5 by the capacitance value in step 3. |
|     |   | Capacitance Drift<br>Within ±0.5% or ±0.05 pF<br>(Whichever is larger)  |   |

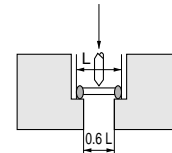
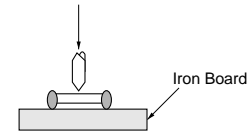

Fig. 4

Speed supplied the Stress Load: 2.5mm / s

| Step | Temperature (°C) |
|------|------------------|
| 1    | 25±2             |
| 2    | -55±3            |
| 3    | 25±2             |
| 4    | 125±3            |
| 5    | 25±2             |

# Mouser Electronics

Authorized Distributor

Click to View Pricing, Inventory, Delivery & Lifecycle Information:

## Murata:

[GCM2195C2A120JD27J](#) [GCM219R72A271KD46F](#) [GCM2165C1H471JA02D](#) [GCM1885C1H470JA16D](#)  
[GCM319R72A681KD79D](#) [GCM1885C1H100FA16D](#) [GCM1885C1H101JA02D](#) [GCM21BR71C334KC01L](#)  
[GCM21BR71H104KA02K](#) [GCM188R71C104KA13D](#) [GCM188R11H103KA01D](#) [GCM1882C1H270JD01D](#)  
[GCM1882C1H101JD01D](#) [GCM1885C1H3R0CD43D](#) [GCM1885C1H3R0CD27D](#) [GCM1885C1H4R0CD27D](#)  
[GCM188R11H331KD01D](#) [GCM2165C1H180JD01D](#) [GCM2165C1H180JD14D](#) [GCM21BR71A105KC16L](#)  
[GCM21BR71A105KC02K](#) [GCM1885C1H120JD30E](#) [GCM2162C1H680JD14D](#) [GCM188R71E273JA02D](#)  
[GCM188R71E223KA02D](#) [GCM2165C1H820JD43D](#) [GCM219R71H123KA01D](#) [GCM188R71C473KA02J](#)  
[GCM1882C1H5R0CD01D](#) [GCM188R11C104KA13D](#) [GCM32RR71H105MA17L](#) [GCM21BR71H473KD58E](#)  
[GCM2165C1H220JD43D](#) [GCM21BR72A103KA02L](#) [GCM21BR72A103KA01K](#) [GCM188R71H331KD01D](#)  
[GCM1885C1H180JA02D](#) [GCM1885C1H9R1CD43D](#) [GCM216R11H821KA01D](#) [GCM32ER71E225KA02L](#)  
[GCM31MR71A225KC25L](#) [GCM32ER71E225MA02L](#) [GCM216R71H472KA19D](#) [GCM216R71H472KA26D](#)  
[GCM216R71H472KA01K](#) [GCM1885C1H270JA01D](#) [GCM188R11H102KA01D](#) [GCM31MR71H154KA37L](#)  
[GCM1885C1H8R0BZ13D](#) [GCM1885C2A102JA16D](#) [GCM188R71C104KA37D](#) [GCM188R72A103KA37D](#)  
[GCM1885C1H1R0CZ13D](#) [GCM3195C1H223JA16D](#) [GCM21BR71C225KA64L](#) [GCM1555C1H100JZ13D](#)  
[GCM32ER71H475KA55L](#) [GCM155R71C104KA55D](#) [GCM31CR71H225KA55L](#) [GCM2195C2A152JA16D](#)  
[GCM1885C2A101JA16D](#) [GCM188R71C474KA55D](#) [GCM188R71H104KA57D](#) [GCM1885C2A100JA16D](#)  
[GCM1555C1H1R0CZ13D](#) [GCM31CR71A106KA64L](#) [GCM3195C2A562JA16D](#) [GCM1885C1H102JA16D](#)  
[GCM155R72A472KA37D](#) [GCM155R71E473KA55D](#) [GCM155R71H102KA37D](#) [GCM155R72A102KA37D](#)  
[GCM188R71H103KA37D](#) [GCM155R71H223KA55D](#) [GCM31CR71E475KA55L](#) [GCM1885C1H100JA16D](#)  
[GCM2195C1H103JA16D](#) [GCM21BR71E225KA73L](#) [GCM32ER71A226KE12L](#) [GCM21BR71E105KA56L](#)  
[GCM1885C2A1R0CZ13D](#) [GCM31CR71C106KA64L](#) [GCM188R72A102KA37D](#) [GCM188R71H102KA37D](#)  
[GCM188R71E474KA64D](#) [GCM188R72A223KA37D](#) [GCM1555C1H471JA16D](#) [GCM155R71H103KA55D](#)  
[GCM1555C1H101JZ13D](#) [GCM21BR72A104KA37L](#) [GCM32ER71E106KA57L](#) [GCM155R71H681KA37D](#)  
[GCM32ER71E225KA17L](#) [GCM31MR71C105KC23L](#) [GCM31MR71C105KC21L](#) [GCM31MR71C105KC02L](#)  
[GCM31MR71C105KC18K](#) [GCM31MR71C105KC16L](#) [GCM32ER71H105MA17L](#) [GCM216R71H222KA19D](#)