

Product Features

- GaAs p-HEMT chip on board
- Limiter–diode insertion
- High Maximum Input Power(+30dBm)
- No matching circuit needed
- Single Supply Voltage (+5V)
- Surface Mount Hybrid Type
- Tape & Reel Packaging
- Small Size, High Heatsink
- Alumina Substrate
- Pb Free / RoHS Standard

Applications

- WiMAX, LTE
- Radar
- Repeater
- Base Station
- RF Sub-Systems



Package Type : CP-16A

Description

This LNA family is a high gain, ultra low noise amplifier

Electrical Specifications

PARAMETER	UNIT	MIN	TYP	MAX
Frequency Range	MHz	2700	-	3500
Small Signal Gain (S ₂₁)	dB	-	11.5	-
Gain Flatness	dB	-	±1.5	-
Input Return Loss (S ₁₁)	dB	-	-14	-
Output Return Loss (S ₂₂)	dB	-	-10	-
1dB Compression Point (P _{1dB})	dBm	18	20	-
Output 3 rd Order Intercept Point (OIP3) (TYP.)	dBm	30	33	-
Noise Figure (TYP.)	dB	-	1.1	1.5
RF Input Power (for 12 hours)	dBm	-	-	30
DC Supply Current (V _{dc} =+5V)	mA	-	100	120

Test Condition

- ① Fc=3100MHz, Supply Voltage = +5V, 50ohm system, Ta = 25 °C
- ② OIP3 is measured with two tones, at an output power of +0dBm/tone separated by 1MHz.

Absolute Maximum Ratings

PARAMETER	UNIT	RATING	REMARK
Device Voltage	V	8	-
RF Input Power	dBm	30	-
Operating Temperature	°C	-40 ~ 85	-
Storage Temperature	°C	-50 ~ 125	-

Note

Operation of this device in excess of any one of these parameters may cause permanent damage.

Functional Diagram

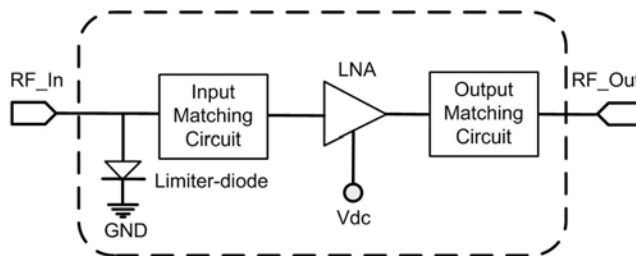

Application Circuit

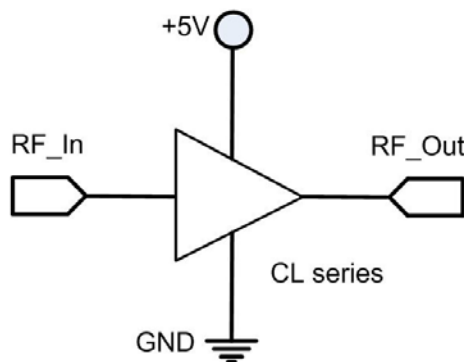

ESD Protection

Gallium Arsenide Integrated Circuits are sensitive to electrostatic discharge (ESD) and can be damaged by static electricity. Proper ESD control techniques should be used when handling these devices. Some of the precautions recommended are;

- Person at a workbench should be earthed via a wrist strap and a resistor.
- All mains-powered equipment should be connected to the mains via an earth-leakage switch.
- Equipment cases should be grounded.
- Relative humidity should be maintained between 40% and 50%.
- An ionizer is recommended.
- Keep static materials, such as plastic envelopes and plastic trays etc. away from the workbench.

CL3102D-L

S-Parameter

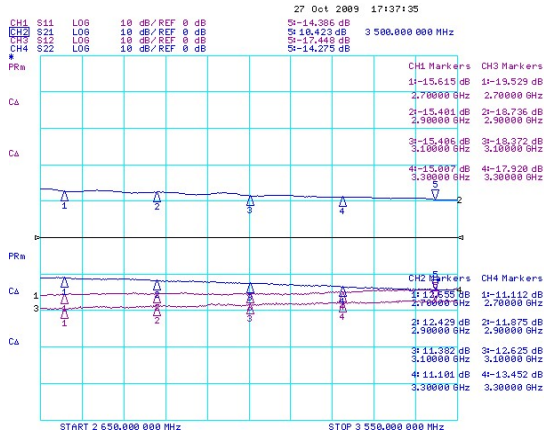

OIP3

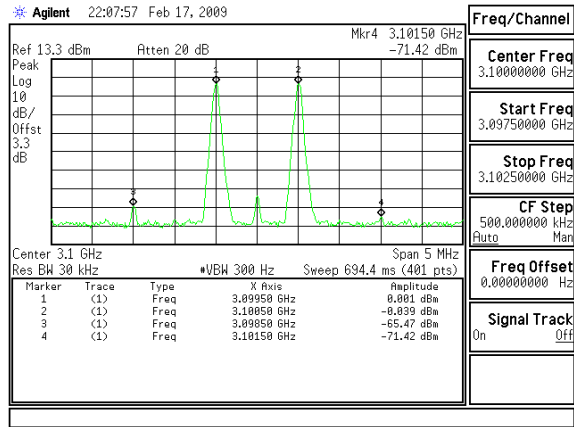

Noise Figure

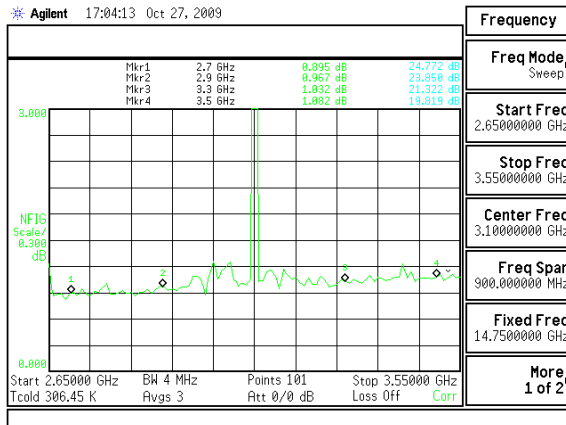

Package Dimensions (Type: CP-16A)

* Unit: mm[inch] | Tolerance ±0.15[.006]

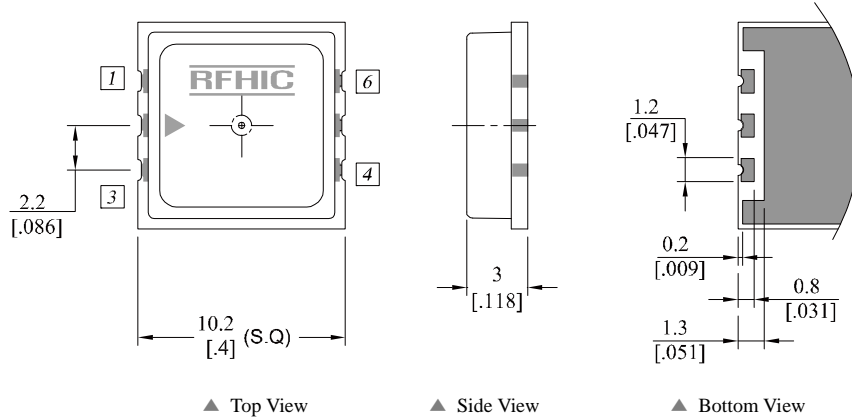

Pin Description			
Pin No	Function	Pin No	Function
1	GND	4	GND
2	Input	5	Output
3	GND	6	Vcc

Recommended Pattern

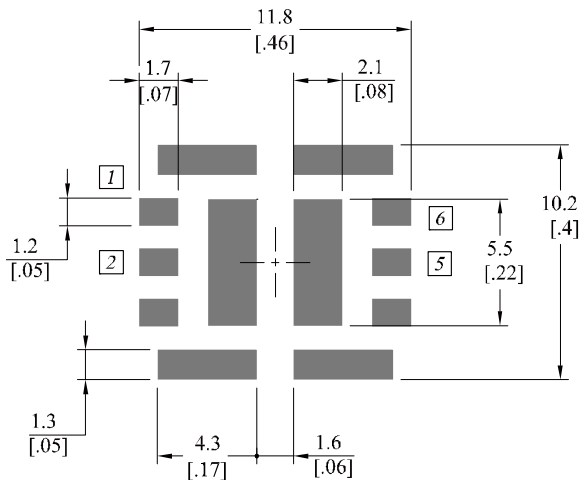

Recommended Mounting Configuration

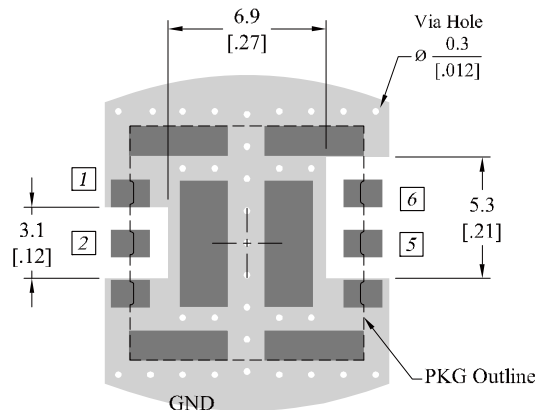

* Mounting Configuration Notes

1. Ground / thermal via holes are critical for the proper performance of this device.
2. Add as much copper as possible to inner and outer layers near the part to ensure optimal thermal performance.
3. Mounting screws can be added near the part to fasten the board to a heatsink. Ensure that the ground / thermal via hole region contacts the heatsink.
4. Do not put solder mask on the backside of the PCB in the region where the board contacts the heatsink.
5. RF trace width depends upon the PCB material and construction.
6. Use 1 oz. Copper minimum.

Revision History

Part Number	Release Date	Version	Modification	Data Sheet Status
CL3102D-L	2012.10.19	1.1	New datasheet format	-
CL3102D-L	2012.2.18	1.0	Initial Release	-

RFHIC Corporation reserves the right to make changes to any products herein or to discontinue any product at any time without notice. While product specifications have been thoroughly examined for reliability, RFHIC Corporation strongly recommends buyers to verify that the information they are using is accurate before ordering. RFHIC Corporation does not assume any liability for the suitability of its products for any particular purpose, and disclaims any and all liability, including without limitation consequential or incidental damages. RFHIC products are not intended for use in life support equipment or application where malfunction of the product can be expected to result in personal injury or death. Buyer uses or sells such products for any such unintended or unauthorized application, buyer shall indemnify, protect and hold RFHIC Corporation and its directors, officers, stockholders, employees, representatives and distributors harmless against any and all claims arising out of such unauthorized use.

Sales, inquiries and support should be directed to the local authorized geographic distributor for RFHIC Corporation. For customers in the US, please contact the US Sales Team at 919-677-8780. For all other inquiries, please contact the International Sales Team at 82-31-250-5078.