

S2E00 Series

1.5W, Ultra-High Isolation DIP, Single & Dual Output DC/DC Converters

Key Features

- Low Cost
- 8000VDC Isolation
- MTBF > 2,000,000 Hours
- 30mV P-P Ripple and Noise
- Input 5, 12 and 15VDC
- Output 5, 12, 15, ± 5 , ± 12 and ± 15 VDC
- Temperature Performance -40°C to $+85^{\circ}\text{C}$
- Low Isolation Capacitance
- Low Leakage Current
- Meets EN60950 and EN60601-1



Minmax's S2E00 Model 1.5W DC/DC's are specially designed to provide 30mA output ripple, continuous short circuit in a low-profile 24-pin DIP package.

The series consists of 18 models with input voltages of 5V, 12V and 15VDC which offers regulated output voltages of 5V, 12V, 15V, ± 5 V, ± 12 V and ± 15 VDC.

The -40°C to $+85^{\circ}\text{C}$ operating temperature range makes it ideal for data communication equipments, mobile battery driven equipments, distributed power systems, telecommunication equipments, mixed analog/digital subsystems, automatic test instrumentation and industrial robot systems.

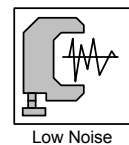
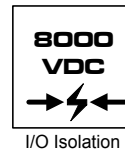
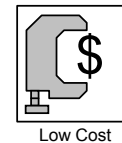

Block Diagram

Single Output

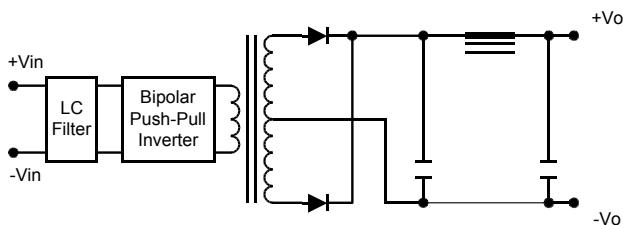

Dual Output

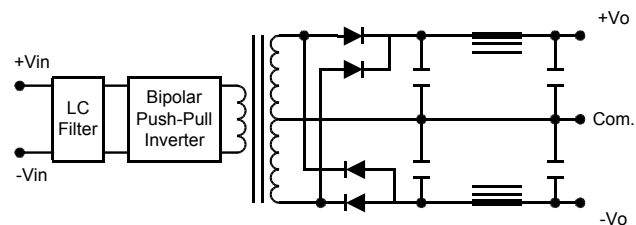

Model Selection Guide

Model Number	Input Voltage	Output Voltage	Output Current		Input Current		Reflected Ripple Current	Efficiency
			Max.	Min.	@Max. Load	@No Load		@Max. Load
	VDC	VDC	mA	mA	mA (Typ.)	mA (Typ.)	mA (Typ.)	% (Typ.)
S2E01	5 (4.5 ~ 5.5)	5	300	0	400	50	30	75
S2E02		12	125		400			75
S2E03		15	100		400			75
S2E04		±5	±150		400			75
S2E05		±12	±63		400			75
S2E06		±15	±50		400			75
S2E07	12 (10.8 ~ 13.2)	5	300	0	167	30	25	75
S2E08		12	125		167			75
S2E09		15	100		167			75
S2E10		±5	±150		167			75
S2E11		±12	±63		167			75
S2E12		±15	±50		167			75
S2E13	15 (13.5 ~ 16.5)	5	300	0	133	30	20	75
S2E14		12	125		133			75
S2E15		15	100		133			75
S2E16		±5	±150		133			75
S2E17		±12	±63		133			75
S2E18		±15	±50		133			75

Absolute Maximum Ratings

Parameter	Min.	Max.	Unit	
Input Surge Voltage (1000 mS)	5VDC Input Models	-0.7	7	VDC
	12VDC Input Models	-0.7	17	VDC
	15VDC Input Models	-0.7	21	VDC
Lead Temperature (1.5mm from case for 10 Sec.)	---	260	°C	
Internal Power Dissipation	---	1,000	mW	

Exceeding the absolute maximum ratings of the unit could cause damage.
These are not continuous operating ratings.

Notes :

- Specifications typical at $T_a=+25^{\circ}\text{C}$, resistive load, nominal input voltage, rated output current unless otherwise noted.
- Ripple & Noise measurement bandwidth is 0-20 MHz.
- All DC/DC converters should be externally fused at the front end for protection.
- Operation under no-load conditions will not damage these modules; however, they may not meet all specifications listed.
- Other input and output voltage may be available, please contact factory.
- Specifications subject to change without notice.

Environmental Specifications

Parameter	Conditions	Min.	Max.	Unit
Operating Temperature	Ambient	-40	+85	°C
Operating Temperature	Case	-40	+95	°C
Storage Temperature		-55	+125	°C
Humidity		---	95	%
Cooling	Free-Air Convection			

S2E00 Series

Input Specifications

Parameter	Model	Min.	Typ.	Max.	Unit
Input Voltage Range	5V Input Models	4.5	5	5.5	VDC
	12V Input Models	10.8	12	13.2	
	15V Input Models	13.5	15	16.5	
Reverse Polarity Input Current	All Models	---	---	0.5	A
Short Circuit Input Power		---	---	1000	mW
Input Filter		Pi Filter			

Output Specifications

Parameter	Conditions	Min.	Typ.	Max.	Unit
Output Voltage Accuracy		---	± 2.0	± 4.0	%
Output Voltage Balance	Dual Output, Balanced Loads	---	± 0.5	± 2.0	%
Line Regulation	For V_{in} Change of 1%	---	± 1.2	± 1.5	%
Load Regulation(5V Output)	$I_o=20\%$ to 100%	---	± 7.0	± 10	%
Load Regulation($\pm 5V$ Output)		---	± 8.0	± 12	%
Load Regulation(12, $\pm 12V$ Output)		---	± 6.0	± 8.0	%
Load Regulation(15, $\pm 15V$ Output)		---	± 4.0	± 6.0	%
Ripple & Noise (20MHz)		---	30	40	mV P-P
Ripple & Noise (20MHz)	Over Line, Load & Temp.	---	---	50	mV P-P
Ripple & Noise (20MHz)		---	---	10	mV rms
Over Load		120	---	---	%
Temperature Coefficient		---	± 0.01	± 0.02	%/°C
Output Short Circuit	Continuous				

General Specifications

Parameter	Conditions	Min.	Typ.	Max.	Unit
Isolation Voltage Rated	60 Seconds	8000	---	---	VDC
Isolation Voltage Test	Flash Tested for 1 Second	8800	---	---	VDC
Leakage Current	240VAC, 60Hz	---	---	2	μA
Isolation Resistance	500VDC	10	---	---	G Ω
Isolation Capacitance	100KHz, 1V	---	10	15	pF
Switching Frequency		50	---	100	KHz
MTBF	MIL-HDBK-217F @ 25°C, Ground Benign	2000	---	---	K Hours

Capacitive Load

Models by V_{out}	5V	12V	15V	$\pm 5V$ #	$\pm 12V$ #	$\pm 15V$ #	Unit
Maximum Capacitive Load	470	470	470	220	220	220	μF

For each output

Input Fuse Selection Guide

5V Input Models	12V Input Models	15V Input Models
1000mA Slow – Blow Type	250mA Slow – Blow Type	250mA Slow – Blow Type

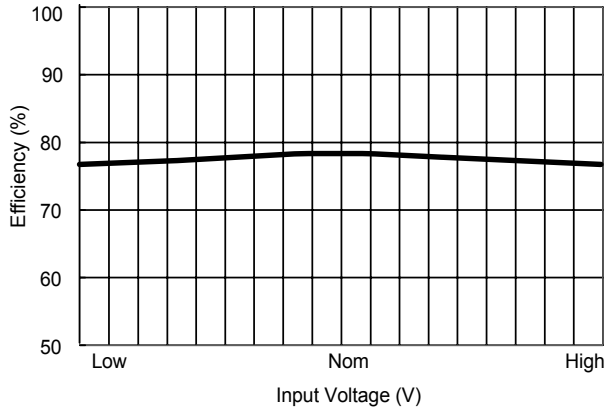

Efficiency vs Input Voltage (Single Output)

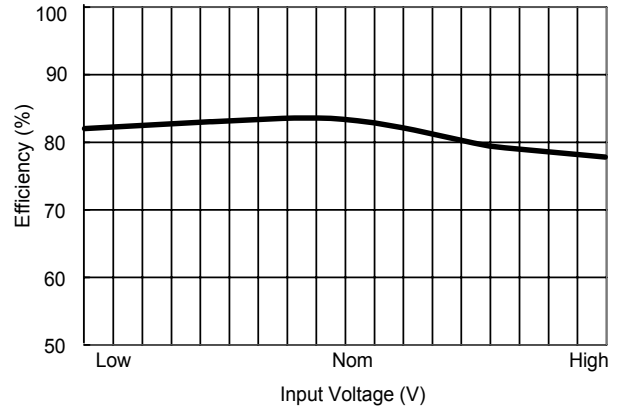

Efficiency vs Input Voltage (Dual Output)

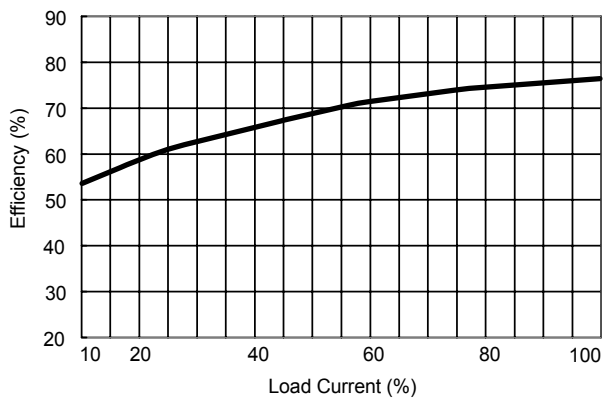

Efficiency vs Output Load (Single Output)

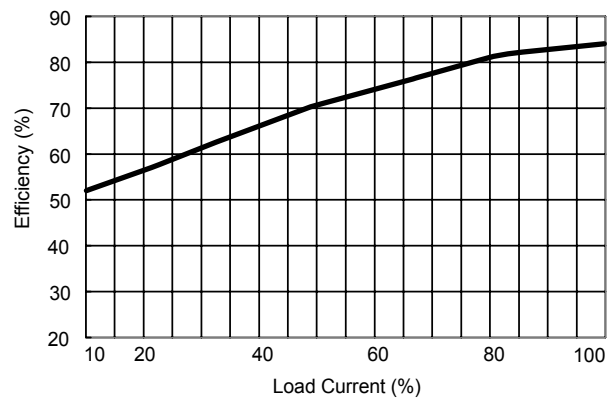

Efficiency vs Output Load (Dual Output)

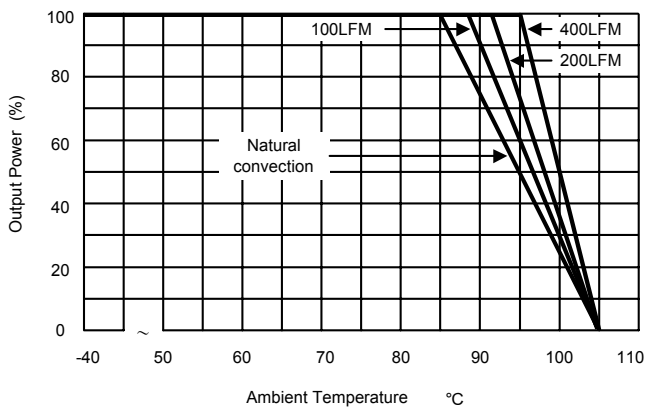

Derating Curve

S2E00 Series

Test Configurations

Input Reflected-Ripple Current Test Setup

Input reflected-ripple current is measured with an inductor L_{in} (4.7 μ H) and C_{in} (220 μ F, ESR < 1.0 Ω at 100 KHz) to simulate source impedance.

Capacitor C_{in} , offsets possible battery impedance.

Current ripple is measured at the input terminals of the module, measurement bandwidth is 0–500 KHz.

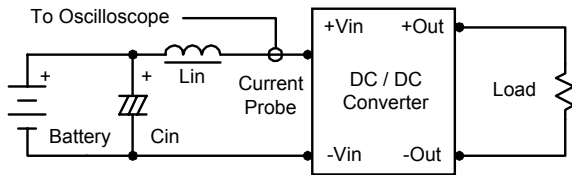

Peak-to-Peak Output Noise Measurement Test

Use a C_{out} 0.33 μ F ceramic capacitor.

Scope measurement should be made by using a BNC socket, measurement bandwidth is 0–20 MHz. Position the load between 50 mm and 75 mm from the DC/DC Converter.

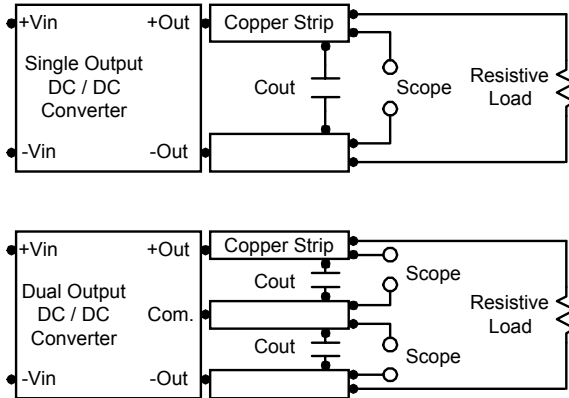

Design & Feature Considerations

Maximum Capacitive Load

The S2E00 series has limitation of maximum connected capacitance at the output.

The power module may be operated in current limiting mode during start-up, affecting the ramp-up and the startup time.

For optimum performance we recommend 220 μ F maximum capacitive load for each dual outputs and 470 μ F capacitive load for single outputs.

The maximum capacitance can be found in the data sheet.

Input Source Impedance

The power module should be connected to a low ac-impedance input source. Highly inductive source impedances can affect the stability of the power module.

In applications where power is supplied over long lines and output loading is high, it may be necessary to use a capacitor at the input to ensure startup.

Capacitor mounted close to the power module helps ensure stability of the unit, it is recommended to use a good quality low Equivalent Series Resistance (ESR < 1.0 Ω at 100 KHz) capacitor of a 2.2 μ F for the 5V input devices, a 1.0 μ F for the 12V input devices and a 0.47 μ F for the 15V devices.

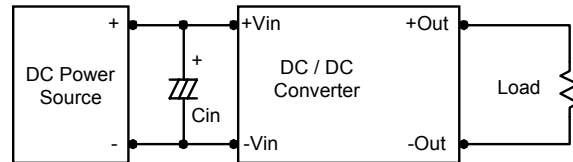

Output Ripple Reduction

A good quality low ESR 1.5 μ F capacitor connected as close as possible to the load is recommended.

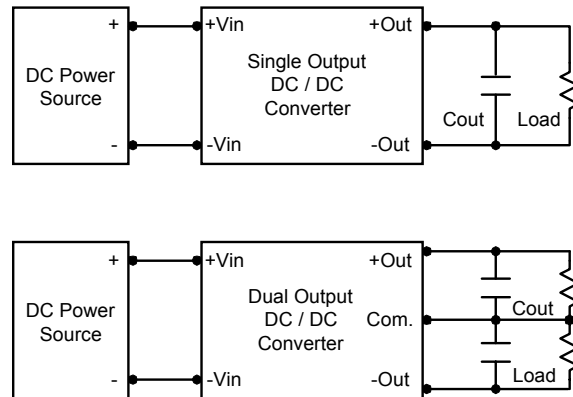

Thermal Considerations

Many conditions affect the thermal performance of the power module, such as orientation, airflow over the module and board spacing. To avoid exceeding the maximum temperature rating of the components inside the power module, the case temperature must be kept below 95°C.

The derating curves are determined from measurements obtained in an experimental apparatus.

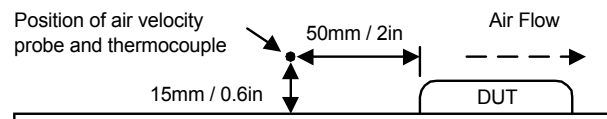

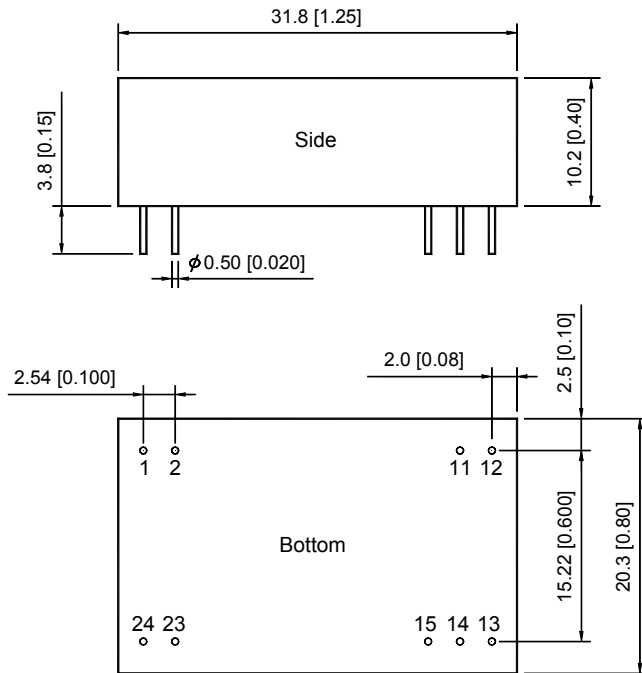
Mechanical Dimensions

Tolerance	Millimeters	Inches
	X.X±0.25	X.XX±0.01
	X.XX±0.13	X.XXX±0.005
Pin	±0.05	±0.002

Connecting Pin Patterns

Top View (2.54 mm / 0.1 inch grids)

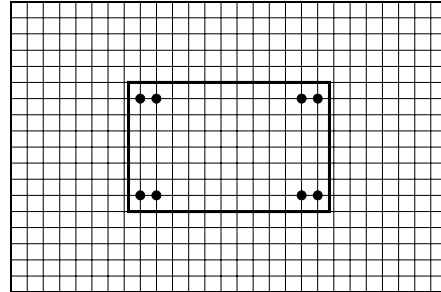
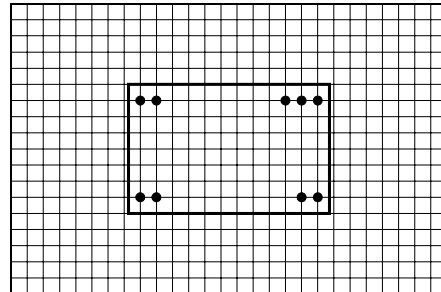
Single Output**Dual Output****Pin Connections**

Pin	Single Output	Dual Output
1	+Vin	+Vin
2	+Vin	+Vin
11	+Vout	+Vout
12	+Vout	+Vout
13	-Vout	Common
14	-Vout	Common
15	No Pin	-Vout
23	-Vin	-Vin
24	-Vin	-Vin

Physical Characteristics

Case Size	: 31.8×20.3×10.2 mm 1.25×0.80×0.40 inches
Case Material	: Non-Conductive Black Plastic
Weight	: 12g
Flammability	: UL94V-0

The S2E00 converter is encapsulated in a low thermal resistance molding compound that has excellent resistance/electrical characteristics over a wide temperature range or in high humidity environments. The encapsulant and unit case are both rated to UL 94V-0 flammability specifications. Leads are tin plated for improved solderability.