

**R3C MALE HOUSING**

**R197.135.\_80**

Series : **SMB**  
**CARLOCK**

To obtain the complete P/N please fill in the blank "\_" with the coding letter

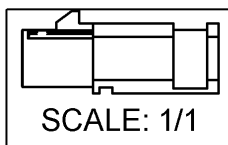
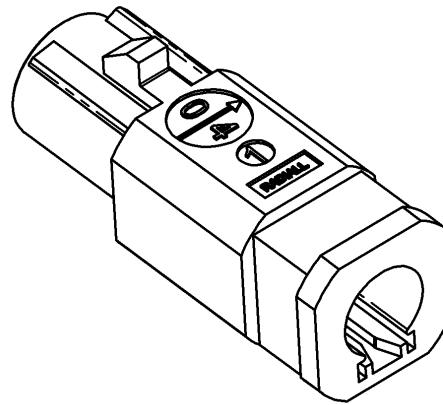
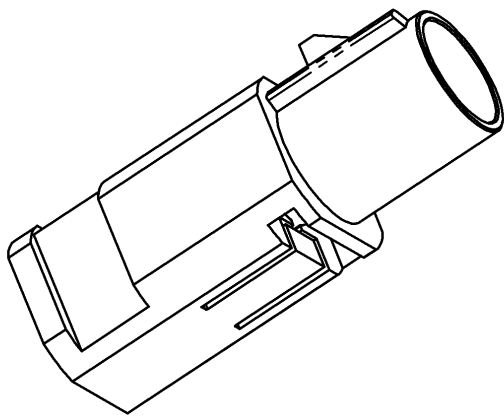
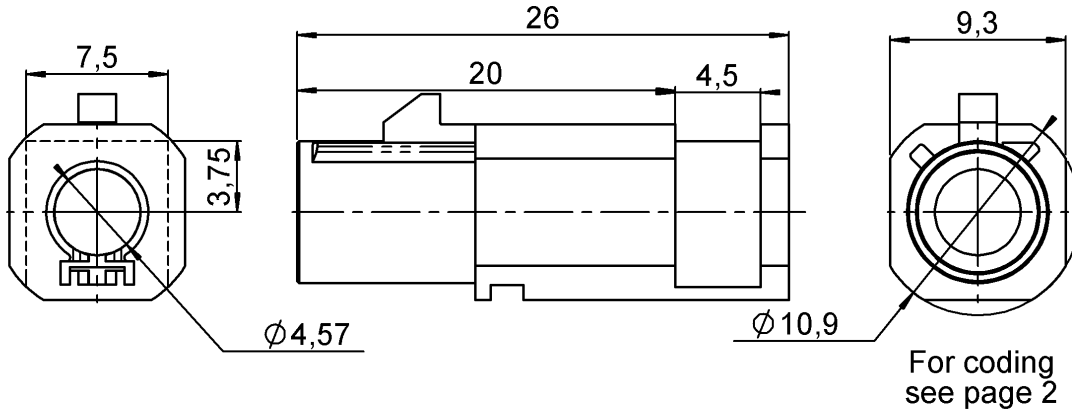

Housing to be used with:  
-R299.197.000  
-R299.197.010

All dimensions are in mm.

COMPONENTS	MATERIALS	PLATING  (µm)	
		UL CLASSIFICATION	COLOR
HOUSING	PA6.6 GF15 (POLYAMIDE)	UL 94 V-2	See Page2

**PACKAGING**

Standard	Unit	Other
500	'W' option	Contact us

**MECHANICAL CHARACTERISTICS**

Mating life **100** Cycles mini  
Weight **1,6500** g

**ENVIRONMENTAL**

Operating temperature **-40/+110** °C

Issue : 0745 A

In the effort to improve our products, we reserve the right to make changes judged to be necessary.



**R3C MALE HOUSING**

**R197.135.\_80**

Series : SMB  
**CARLOCK**



**CODING A**  
 COLOR BLACK  
 RAL 9005



**CODING B**  
 COLOR CREAMWHITE  
 RAL 9001



**CODING C**  
 COLOR BLUE  
 RAL 5005



**CODING D**  
 COLOR BORDEAUX  
 VIOLET  
 RAL 4004

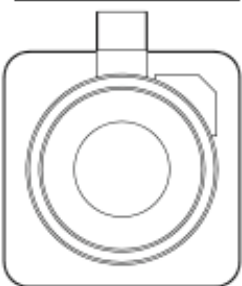

**CODING E**  
 COLOR GREEN  
 RAL 6002



**CODING F**  
 COLOR BROWN  
 RAL 8011



**CODING G**  
 COLOR GREY  
 RAL7031



**CODING H**  
 COLOR VIOLET  
 RAL 4003

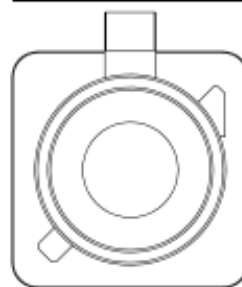

**CODING I**  
 COLOR BEIGE  
 RAL 1001

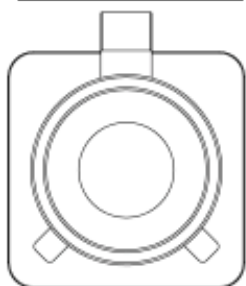

**CODING K**  
 COLOR CURRY  
 RAL 1027

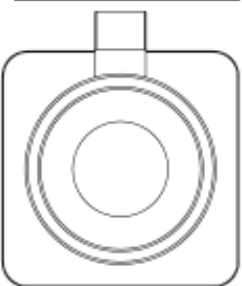

**CODING Z**  
 COLOR WATER BLUE  
 RAL 5021

**UL CLASSIFICATION**  
 UL 94V-2

**-To obtain the complete P/N please fill in the blank "\_ " with the coding letter**

Issue : 0745 A

In the effort to improve our products, we reserve the right to make changes judged to be necessary.



R3C MALE HOUSING

**R197.135.\_80**

Series : SMB  
CARLOCK

**RECOMMENDED MOUNTING PROCEDURE**

1

● **Pre-insertion of the coax into the housing**

● **Orientation of the tab of the coax with the slot of the housing.**

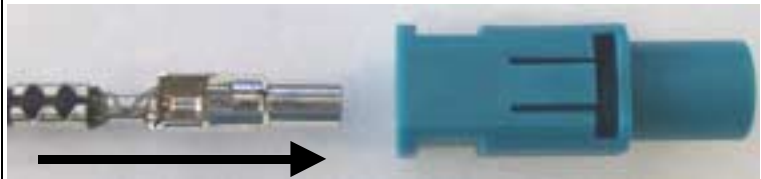

Orientation of the slot

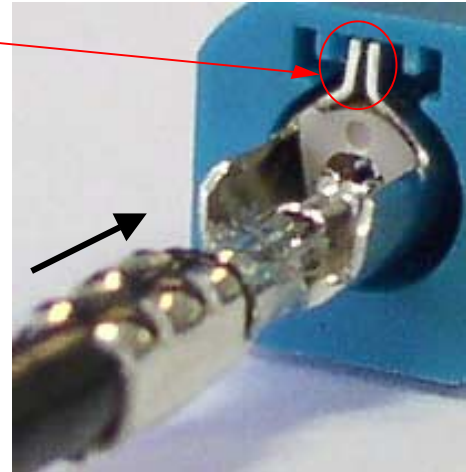

2

● **Push the connector into the housing until it clip on.**

● **Optional: verify if the coax is well mounted by rotating the housing.**

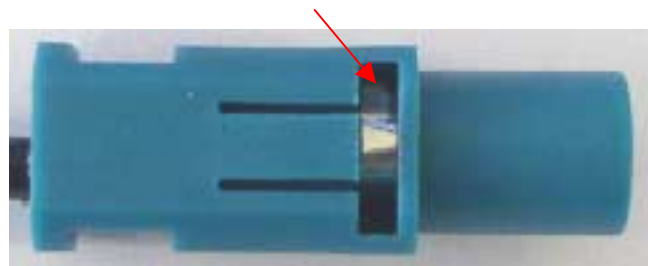
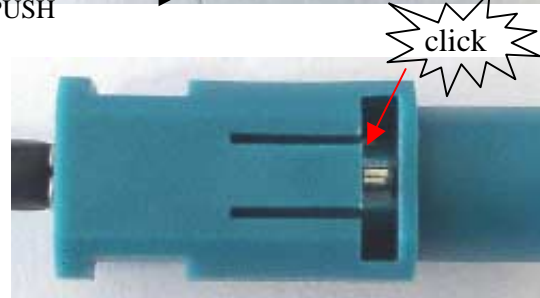
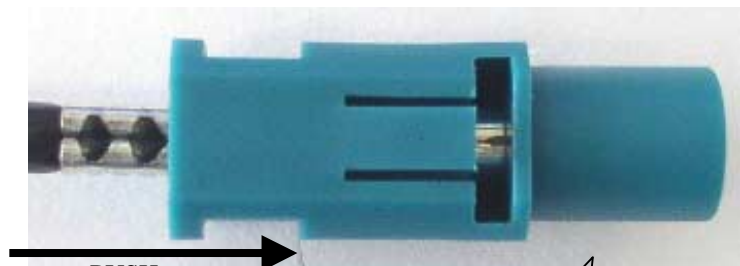

Issue : 0745 A

In the effort to improve our products, we reserve the right to make changes judged to be necessary.

R3C MALE HOUSING

**R197.135.\_80**

Series : SMB  
CARLOCK

**RECOMMENDED DISASSEMBLING PROCEDURE**

1

- To unlock the coax from the housing, rotate the coax until the tab is not in front of the elastic finger of the housing.
- insert a screw driver between the elastic finger and the slot of the housing as shown on the picture.
- Tip down the screw driver as shown on the picture to lift up the elastic finger until you have enough room.

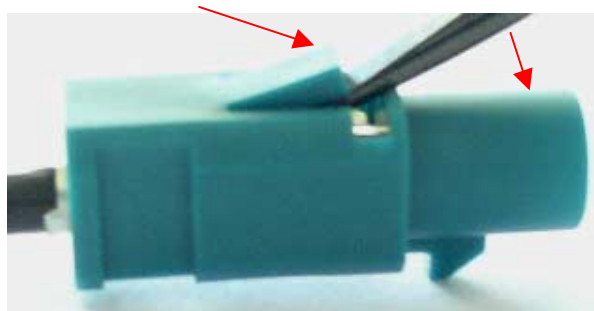
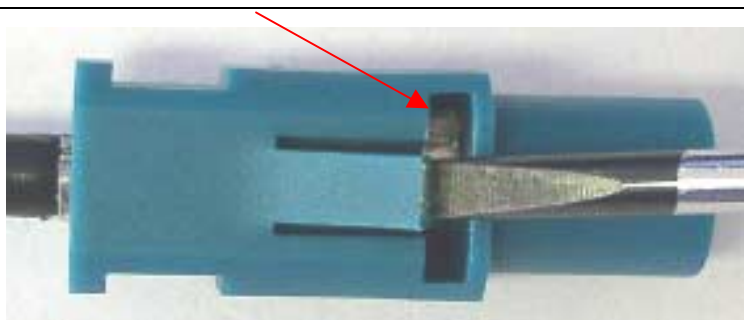

2

- Hold on the elastic finger up and rotate the coax until the tab is in front of the elastic finger of the housing. (you can use the crimping of the jacket as a reference).
- pull on the cable assembly to remove the coax from the housing.

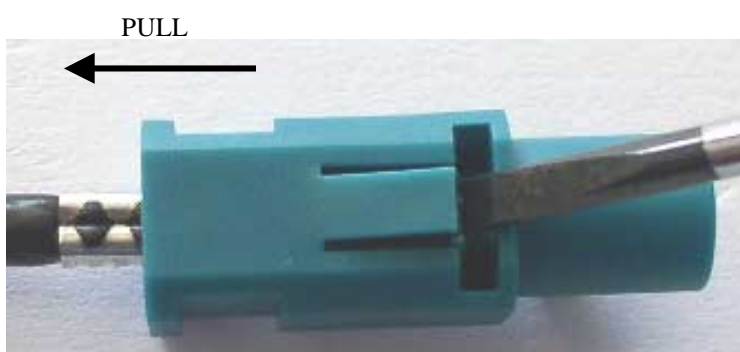

Issue : 0745 A

In the effort to improve our products, we reserve the right to make changes judged to be necessary.

