

Features/Benefits

- Internal actuator seal and insert molded terminals—permit soldering and cleaning
- Tin-lead plated terminals—improves solderability
- Tape and reel packaging available
- Right angle surface mount models available

Typical Applications

- Telecommunications
- Computer Products
- Instrumentation

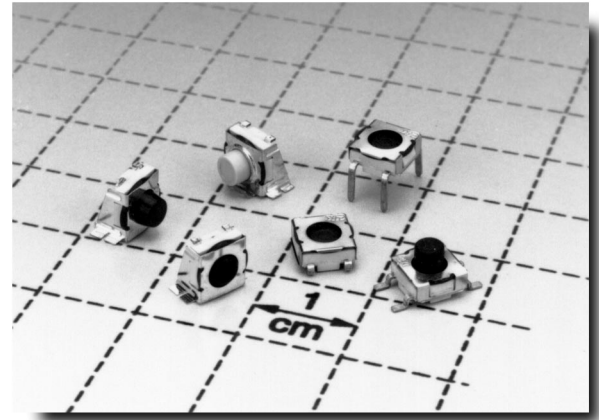

How To Order

Complete part numbers for KT Series Sealed Tactile Switches are shown on pages C-3 thru C-5.

Specifications

CONTACT RATING: 1.0 VA max. @ 50 V AC or DC max.

MECHANICAL & ELECTRICAL LIFE: 100,000 make-and-break cycles at full load.

CONTACT RESISTANCE: Below 50 milliohms typ. initial @ 2-4 V DC, 100 mA.

INSULATION RESISTANCE: 10^9 ohms min.

DIELECTRIC STRENGTH: 250 V RMS min. @ sea level.

OPERATING TEMPERATURE: -40°C to 90°C .

SOLDERABILITY: Per MIL-STD-202F method 208D, or EIA RS-186E method 9 (1 hour steam aging).

DEGREE OF PROTECTION: IP57; Protection against harmful dust deposit, full-scale voltage protection, temporary immersion.

PACKAGING: Switches supplied in rigid dispensing tubes or anti-static tape and reels per EIA 481-2, see pages L-36 and L-37 for drawings and reel information. Tape and cover strip are conductive for use near statically sensitive components, consult Customer Service Center.

Materials

HOUSING: Stainless steel.

BASE: LCP or PPA (UL 94V-0).

ACTUATOR: B0, B1, B2 actuators: Silicone rubber.

P2, P3, P4 actuators: Nylon (UL 94V-0).

MOVABLE CONTACT: Stainless steel, silver plated.

STATIONARY CONTACTS: Copper alloy, silver plate over nickel.

TERMINALS: Copper alloy, with tin-lead alloy over nickel plate.

All terminals insert molded.

SEAL: Silicone rubber (UL 94V-0).

NOTE: Specifications and materials listed above are general specifications for switches with standard options. For information on specific and custom switches, consult Customer Service Center.

CAUTION: PC mounting layouts and pads as shown are designed to be compatible with the latest equipment and reflow techniques. Care should be taken in the design and location of PC lands to suit individual needs. Orientation relative to reflow direction may significantly impact solder joint integrity.

6.22 x 6.38mm Models

PART NUMBER	ACTUATOR HEIGHT	SWITCH FUNCTION	
		POS. 1	POS. 2
KT11B0CM	FLUSH	OFF	MOM.
KT11B1CM	.025 (0,64)	OFF	MOM.
KT11B2CM	.088 (2,24)	OFF	MOM.
KT11P2CM	.093 (2,36)	OFF	MOM.
KT11P3CM	.044 (1,12)	OFF	MOM.
KT11P4CM	.156 (3,96)	OFF	MOM.
Conn. Terms		OPEN	1,2-3,4
Schematic			
SPST			

MOM. = Momentary

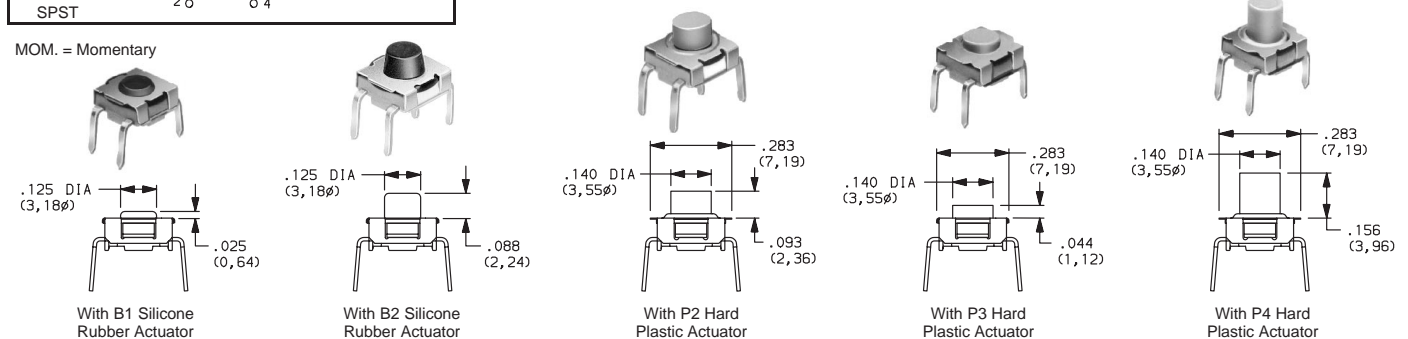

KT Series Sealed Tactile Switches



6.22 x 6.38mm Surface Mount Models

SMT



KT11B0JM
SPST

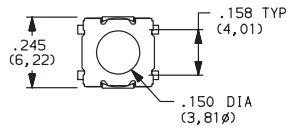

PC MOUNTING

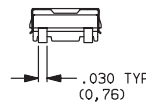
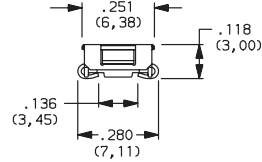
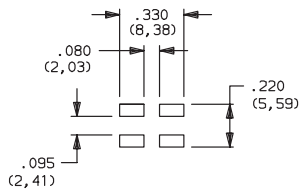

PART NUMBER	ACTUATOR HEIGHT	SWITCH FUNCTION	
		POS. 1	POS. 2
KT11B0JM	FLUSH	OFF	MOM.
KT11B1JM	.025 (0,64)	OFF	MOM.
KT11B2JM	.088 (2,24)	OFF	MOM.
KT11P2JM	.093 (2,36)	OFF	MOM.
KT11P3JM	.044 (1,12)	OFF	MOM.
KT11P4JM	.156 (3,96)	OFF	MOM.
Conn. Terms		OPEN	1, 2-3, 4
Schematic			
SPST			

MOM. = Momentary

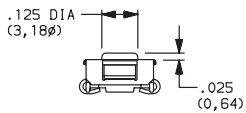

With B1 Silicone Rubber Actuator

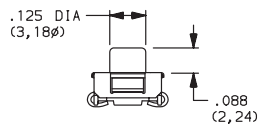

With B2 Silicone Rubber Actuator

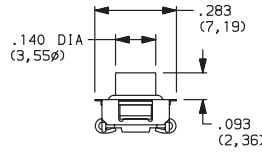

With P2 Hard Plastic Actuator

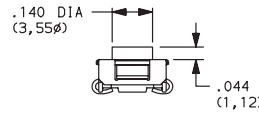

With P3 Hard Plastic Actuator

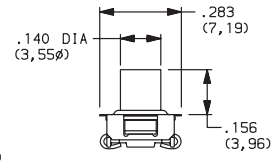

With P4 Hard Plastic Actuator

6.22 x 6.38mm Surface Mount Models

SMT



KT11B0SM
SPST

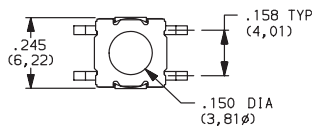

PC MOUNTING

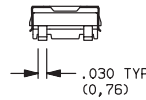
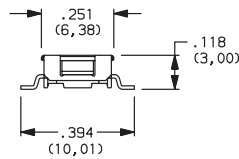
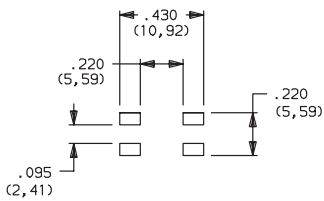

PART NUMBER	ACTUATOR HEIGHT	SWITCH FUNCTION	
		POS. 1	POS. 2
KT11B0SM	FLUSH	OFF	MOM.
KT11B1SM	.025 (0,64)	OFF	MOM.
KT11B2SM	.088 (2,24)	OFF	MOM.
KT11P2SM	.093 (2,36)	OFF	MOM.
KT11P3SM	.044 (1,12)	OFF	MOM.
KT11P4SM	.156 (3,96)	OFF	MOM.
Conn. Terms		OPEN	1, 2-3, 4
Schematic			
SPST			

MOM. = Momentary

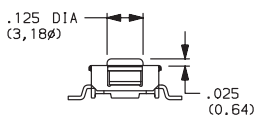

With B1 Silicone Rubber Actuator

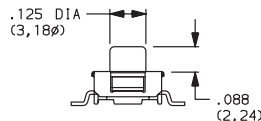

With B2 Silicone Rubber Actuator

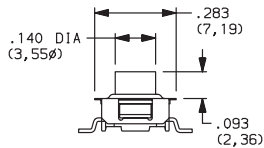

With P2 Hard Plastic Actuator

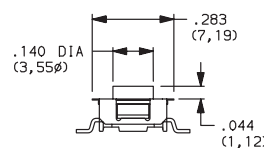

With P3 Hard Plastic Actuator

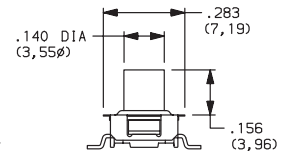

With P4 Hard Plastic Actuator

6.60 x 6.60mm Right Angle Models

PART NUMBER	ACTUATOR HEIGHT	SWITCH FUNCTION	
		POS. 1	POS. 2
KT11B0SAM	FLUSH	OFF	MOM.
KT11B1SAM	.025 (0,64)	OFF	MOM.
KT11B2SAM	.088 (2,24)	OFF	MOM.
Conn. Terms		OPEN	2-4
Schematic			
SPST			

MOM. = Momentary

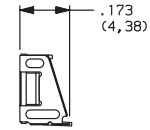
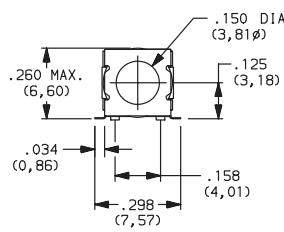

KT11B0SAM
SPST

SMT

PC MOUNTING

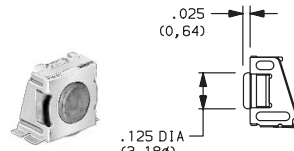
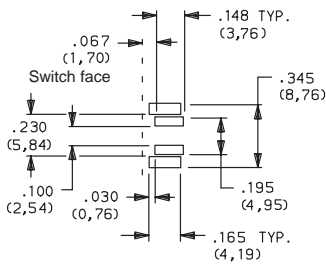

With B1 Silicone
Rubber Actuator

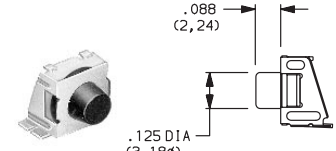

With B2 Silicone
Rubber Actuator



C

Tactile

6.30 x 6.38mm Right Angle Models

PART NUMBER	ACTUATOR HEIGHT	SWITCH FUNCTION	
		POS. 1	POS. 2
KT11P2SA1M	.093 (2,36)	OFF	MOM.
KT11P3SA1M	.059 (1,50)	OFF	MOM.
KT11P4SA1M	.156 (3,96)	OFF	MOM.
Conn. Terms		OPEN	1,2-3,4
Schematic			
SPST			

MOM. = Momentary

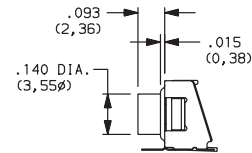
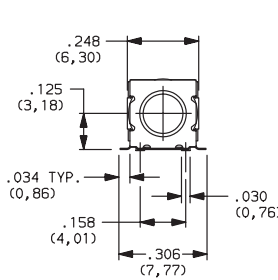

KT11P2SA1M
SPST

SMT

PC MOUNTING

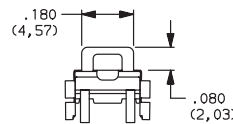
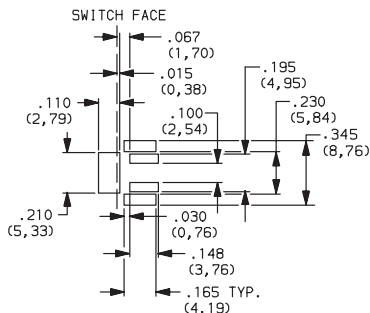

With P3 Hard
Plastic Actuator

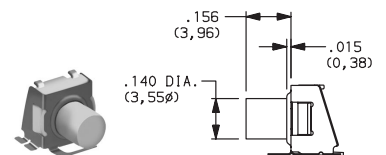

With P4 Hard
Plastic Actuator