

# TFT LCD MONITOR PRODUCT SPECIFICATION

**MODEL: KT-EA19ZX---05**



**Prepared by KORTEK R&D CENTER**

**KORTEK CORPORATION**

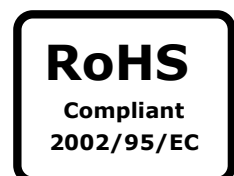

**Note: Any Modification or Copy of Spec is not allowed without KORTEK's Permission.**

## Contents

<b>1. Revision History</b> .....	<b>3</b>
<b>2. Scope</b> .....	<b>4</b>
<b>3. Feature</b> .....	<b>4</b>
<b>4. Electrical Specification</b>	
<b>4.1 Input Power</b> .....	<b>4</b>
<b>4.2 Input Signal</b> .....	<b>4</b>
<b>4.3 Display Color</b> .....	<b>5</b>
<b>4.4 Mode &amp; Timing</b> .....	<b>6 ~ 7</b>
<b>5. LCD Panel Specification</b>	
<b>5.1 Screen Specification</b> .....	<b>8 ~ 9</b>
<b>5.2 Test Equipment Setup</b> .....	<b>10</b>
<b>5.3 Backlight Unit</b> .....	<b>11</b>
<b>5.4 CIE Coordinates</b> .....	<b>11</b>
<b>5.5 Absolute Maximum Rating</b> .....	<b>12</b>
<b>6. Visual Specification</b>	
<b>6.1 Standard Mode &amp; Display Size</b> .....	<b>13</b>
<b>6.2 Standard Condition</b> .....	<b>13</b>
<b>6.3 Screen Image Stabilizing time</b> .....	<b>13</b>
<b>6.4 H.V Centering</b> .....	<b>13</b>
<b>6.5 Focus</b> .....	<b>14</b>
<b>6.6 Color Spread</b> .....	<b>14</b>
<b>6.7 Noise Jitter</b> .....	<b>14</b>
<b>6.8 Residual Image</b> .....	<b>14</b>
<b>6.9 Crosstalk</b> .....	<b>14</b>
<b>7. A/D Board</b>	
<b>7.1 A/D Board Dimension</b> .....	<b>15</b>
<b>7.2 A/D Board connection</b> .....	<b>15~ 17</b>
<b>8. Inverter Specification</b>	
<b>8.1 Dimension</b> .....	<b>18</b>
<b>8.2 Input Connector</b> .....	<b>18</b>
<b>8.3 Output Connector</b> .....	<b>18</b>
<b>9. User Interface</b>	
<b>9.1 OSD Key Dimension</b> .....	<b>19</b>
<b>9.2 OSD Menu Structure</b> .....	<b>19</b>
<b>10. Mechanical Specification</b>	
<b>10.1 Outline Dimension</b> .....	<b>20</b>

**1. Revision History**

<b>Date</b>	<b>Rev. No</b>	<b>Page</b>	<b>Summary</b>
2013-01-18	Rev0.0	All	1'st issued



## 2. Scope

This document is the specification of 19" TFT-LCD MONITOR for application of Multi -sync.  
KT-EA19ZX---05 is a High quality TFT-LCD display solution for industrial display device having RoHS conformity.

## 3. Features

- Native Resolution: SXGA (1,280 \* 1,024 @60Hz) Recommend (1,280 \* 1,024 @ 60Hz)
- Image Screen Input Signal: Analog, DVI (Optional)
- Flexible Solution of Mechanical Mounting
- On Screen display (OSD)

## 4. Electrical Specification

### 4.1 Input Power

4.1.1 Input power is required as

Voltage: DC +12[V] / 3[A]

Consumption: 30[W] Max

4.1.2 Power Management

Mode	V-Sync	H-Sync	Video	Power Consumption
ON	Pulse	Pulse	Active	Less than 30[W]
Stand By	Pulse	No Pulse	Blanked	Less than 4.5[W]
Suspend	No Pulse	Pulse	Blanked	Less than 4.5[W]
Off	No Pulse	No Pulse	Blanked	Less than 4.5[W]

※ Transition between states shall not require any manual display adjustment otherwise noted.  
There is no restriction on any combination of state transition. It is recommended that the display wait for about 2 seconds before transition. From "on" to avoid unintentionally entering a power saving state during change resolution or frequency.

### 4.2 Input Signal

4.2.1 Analog R,G,B input

Signal: RED, GREEN, BLUE

Polarity: Positive

Level: Analog from 0.714 to 2.5 [V<sub>p-p</sub>]

Maximum Dot Clock: 165[MHz]

#### 4.2.2 Horizontal Sync

Polarity: (+) or (-) H, V Separate, Composite sync

Level: TTL Compatible

High: 2.4 ~ 5.0[V]

Low: 0.0 ~ 0.8[V]

Scan Frequency: 15 ~ 80.0[KHz]

#### 4.2.3 Vertical Sync

Polarity: Positive or Negative H&V Separate

Level: TTL Compatible

High: 2.4 ~ 5.0 Volt

Low: 0.0 ~ 0.8 Volt

Scan Frequency: 55 ~ 75[Hz]

#### 4.2.4 Scanning Mode : Non-Interlaced and Interlaced modes

### 4.3 Display Color : 16,777,216 colors



## 4.4 Mode & Timing

### 4.4.1 Preset Mode Timing Chart

#### ① Time Block

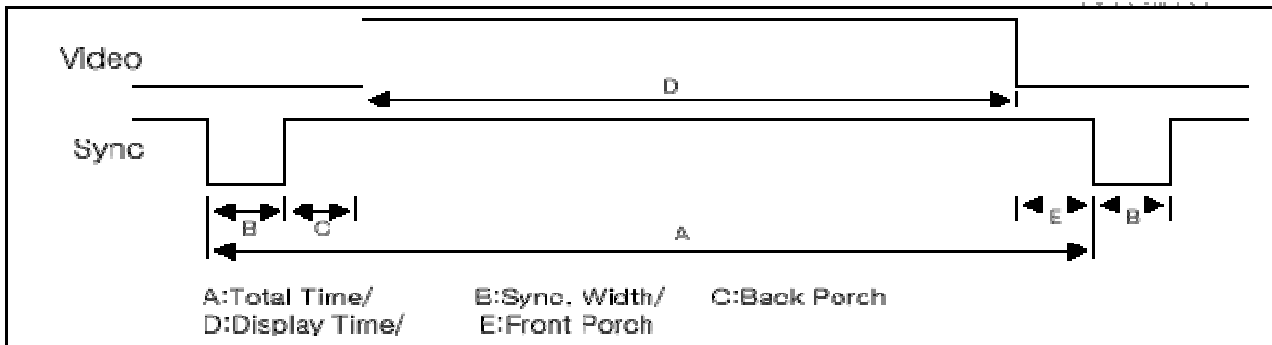

#### ② Detail Timing VESA Standard

Description	Mode1	Mode2	Mode3	Mode4	Mode5	Mode6	Mode7	Mode8	Mode9	
	720	640		800		1024		1280		
	400	480		600		768		1024		
H	Freq [KHz]	31.649	31.469	37.500	37.879	46.875	48.363	60.023	63.938	79.976
	A [Pixels]	31.778	31.778	26.667	26.400	21.333	20.667	16.660	15.630	12.504
	B [Pixels]	3.813	3.813	2.032	3.200	1.616	2.092	1.219	1.037	1.067
	C [Pixels]	1.907	1.907	3.810	2.200	3.232	2.462	2.235	2.296	1.837
	D [Pixels]	25.422	25.422	20.317	20.000	16.162	15.754	13.003	11.852	9.481
	E [Pixels]	0.636	0.636	0.508	1.000	0.323	0.369	0.203	0.444	0.119
	Pol	NEG	NEG	NEG	POSI	POSI	NEG	POSI	POSI	POSI
V	Freq [KHz]	70.087	59.941	75.000	60.317	75.000	60.004	75.029	60.020	75.025
	A [Lines]	14.268	16.683	13.333	16.579	13.333	16.666	13.328	16.661	13.329
	B [Lines]	0.064	0.064	0.080	0.106	0.064	0.124	0.050	0.047	0.038
	C [Lines]	1.112	1.049	0.427	0.607	0.448	0.600	0.466	0.594	0.475
	D [Lines]	12.711	15.253	12.807	15.840	12.800	15.880	12.796	16.005	12.804
	E [Lines]	0.381	0.317	0.019	0.026	0.021	0.062	0.017	0.016	0.013
	Pol	POSI	NEG	NEG	POSI	POSI	NEG	POSI	POSI	POSI
Pixel Clock [MHz]	28.322	25.175	31.500	40.000	49.500	65.000	78.750	108.000	135.000	

## 4.4.2 Supply Video Timing Chart (VESA)

: Native Mode

Resolution	Refresh Rate	H Frequency	Main Frequency	Remark
<b>640 x 350</b>	70 Hz	31.5 kHz	25.175 MHz	
<b>720 x 400</b>	70 Hz	31.5 kHz	28.322 MHz	Text Mode
<b>640 x 480</b>	60 Hz	31.5 kHz	25.175 MHz	n/a
	72 Hz	37.9 kHz	31.500 MHz	VESA
	75 Hz	37.5 kHz	31.500 MHz	VESA
<b>800 x 600</b>	56 Hz	35.1 kHz	36.000 MHz	VESA
	60 Hz	37.9 kHz	40.000 MHz	VESA
	72 Hz	48.1 kHz	50.000 MHz	VESA
	75 Hz	46.9 kHz	49.500 MHz	VESA
<b>1024 x 768</b>	60 Hz	48.4 kHz	65.000 MHz	VESA
	70 Hz	56.5 kHz	75.000 MHz	VESA
	75 Hz	60.0 kHz	78.750 MHz	VESA
<b>1152 X864</b>	75 Hz	67.5 KHz	108.00 MHz	VESA
<b>1280 x 960</b>	60 Hz	60.0 kHz	108.00 MHz	VESA
<b>1280 x 1024</b>	60 Hz	64.0 kHz	108.00 MHz	VESA
	75 Hz	80.0 kHz	135.00 MHz	VESA

## 5. LCD Panel Specifications

### 5.1 Screen Specification

Item	Specification	Unit	Remark	Note
Display Area	376.32 (H) x 301.06 (V) mm (Typ.)	mm		
Driver Element	a-Si TFT active matrix	Dot		
Display Colors	16,78M (RGB 6-bit + Hi FRC)	Color		
Number of Pixel	1,280 x 1,024	Pixel		
Pixel Arrangement	RGB Vertical Stripe			
Pixel Pitch	0.294(H) x 0.294(W)	mm		
Display Mode	Normally White			
Viewing Angle	85/85/85/85 (U/D/L/R)	Degrees	CR=10	①
Weight	1,800g (Max.)	g		
Contrast Ratio	Typ = 1000:1		Center of Screen	② ④ ⑤
Response Time	On/Off = 5 ms		Typ.	③
White Luminance	Typ = 250cd/m <sup>2</sup>	cd/m <sup>2</sup>	Center of Screen	④ ⑤
Brightness Uniformity	Typ = 80 % (Max.)	%		⑥
Dimensions	396.0 (H) x 324.0 (V) x 10.9 (D) (Typ)	mm		

© Vendor Name: AUO(M190ETN01.0)

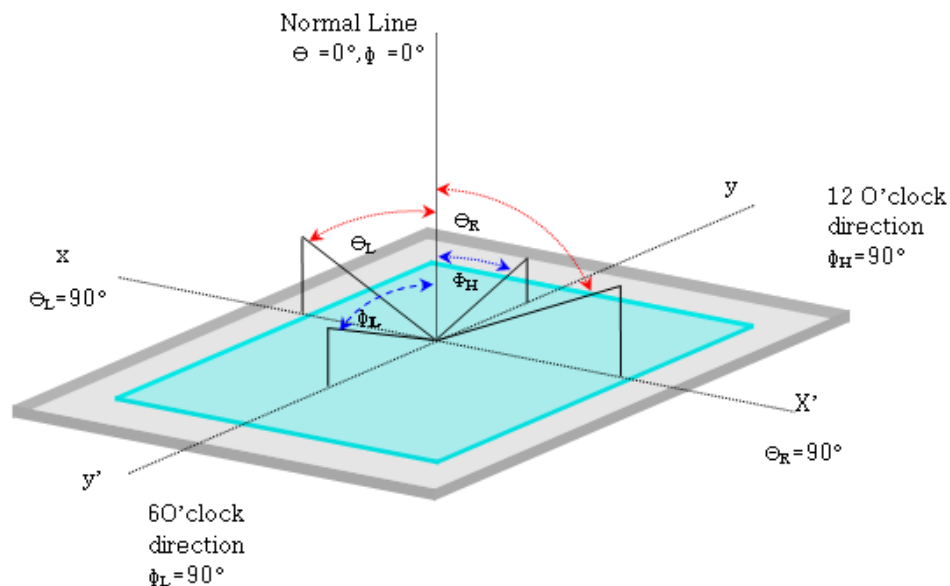



## ① Viewing Angle

Hor.	$\theta_L$	CR $\geq$ 10 (at center of screen)	Right	85	Degree
	$\theta_R$		Left	85	
Ver.	$\phi_H$		Up	85	
	$\phi_L$		Down	85	

② Contrast Ratio (CR): Ratio of gray max. (G max.), gray min. (G min.) at the center point of panel.

$$CR = \frac{\text{Luminance of all pixels White}}{\text{Luminance of all pixels black}}$$

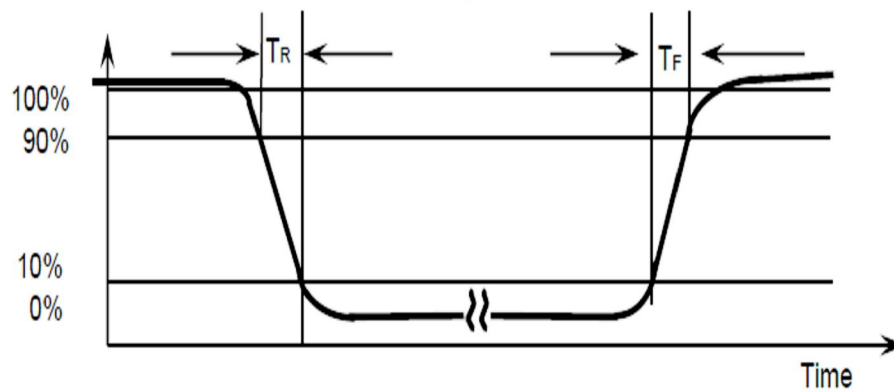
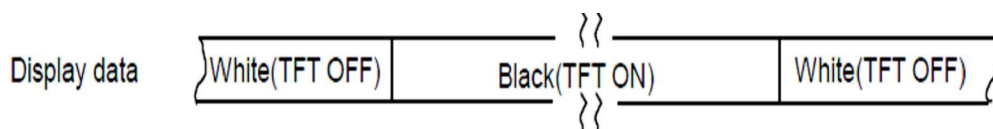

③ Response Time: Sum of  $T_R, T_F$

④ Luminance of White (Center of Screen)

$$Y_L = 250 \text{ cd/m}^2 \text{ (Typ.)}$$

⑤ Optical characteristics measurement

### 5.2 Test Equipment Setup

After stabilizing and leaving the panel alone at a given temperature for 30 min, the measurement should be executed. Measurement should be executed in a stable, windless, and dark room 30 min after lighting the back-light. This should be measured in the center of screen. A single lamp current: 6.5[mA] Environment condition:  $T_a = 25 \pm 2 [^{\circ}\text{C}]$

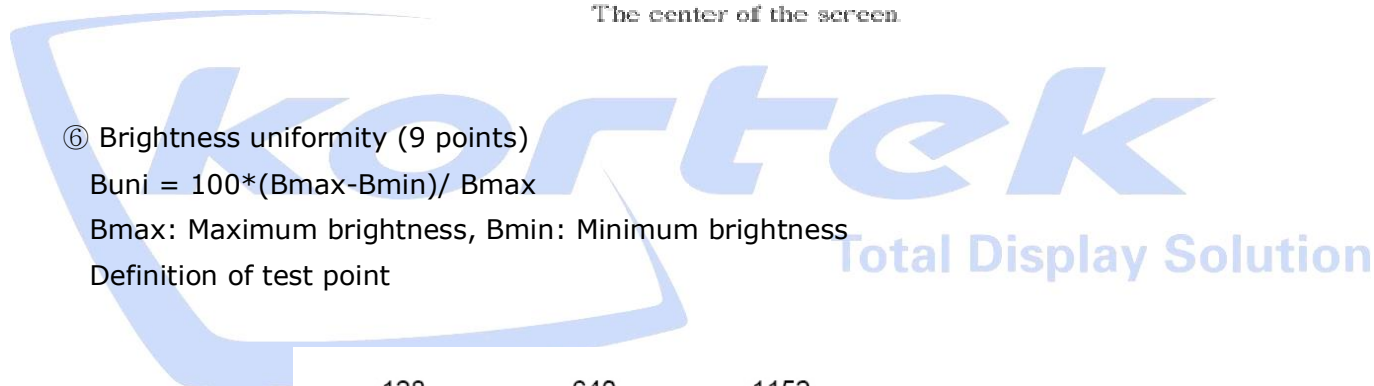
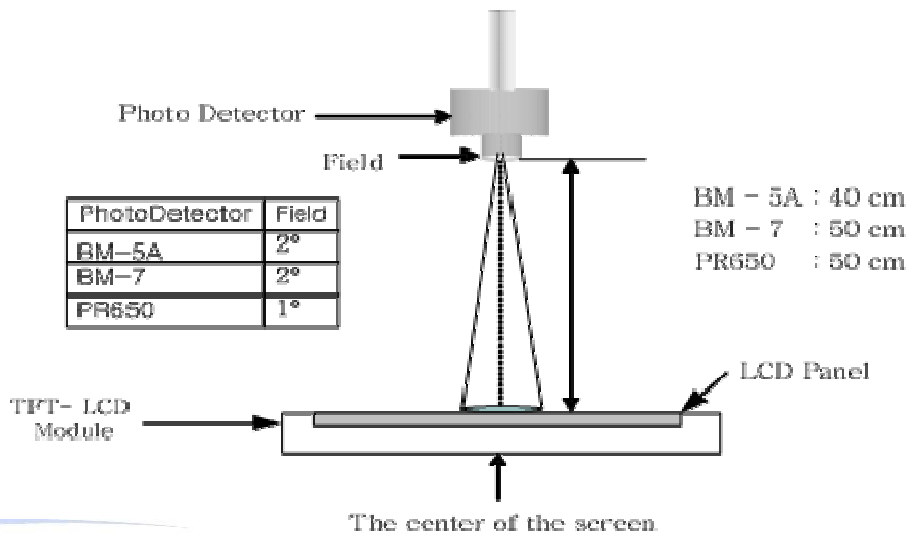

⑥ Brightness uniformity (9 points)

$$B_{uni} = 100 * (B_{max} - B_{min}) / B_{max}$$

B<sub>max</sub>: Maximum brightness, B<sub>min</sub>: Minimum brightness

Definition of test point

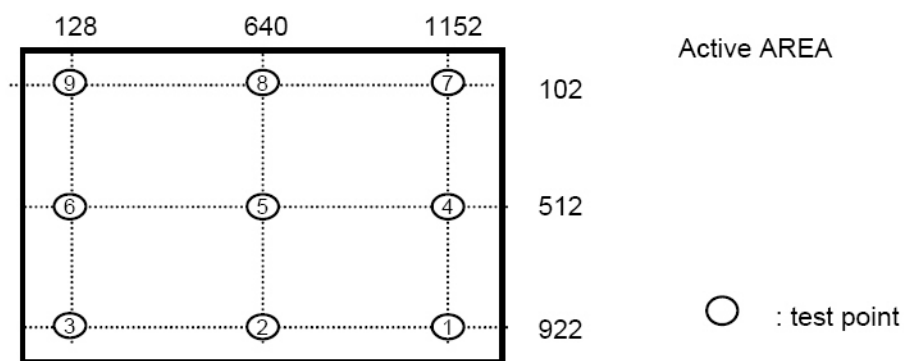

### 5.3 Back Light Unit

The Back-light system is an edge-lighting type with 2 dual CCFTs. (Cold Cathode Fluorescent Tube)

Item	Symbol	Min	Max	Unit	Conditions
LED Forward Current	IRLED1	0	90	[mA]	Note 1,2,5 100% duty
	IRLED2				
	IRLED3				
	IRLED4				
LED Pulse Forward Current	IPLED1	-	150	[mA]	Note 1,2,5 10% duty @ 100Hz
	IPLED2				
	IPLED3				
	IPLED4				
LED Forward Voltage Variation	V <sub>f</sub>	-	3.4	[Volt]	Note 1,2

Note 1 : With in Ta(25°C)

Note 2 : Permanent damage to the device may occur if exceeding maximum values

Note 5 : IRLED1,2,3,4, and IPLED 1,2,3,4 define as per strings led current

### 5.4 CIE Coordinates (Color Chromaticity)

Item	Color chromaticity (CIE 1931)	
	X(Typ.)	Y(Typ.)
Red	0.636±0.03	0.316 ±0.03
Green	0.324 ±0.03	0.627 ±0.03
Blue	0.154 ±0.03	0.054 ±0.03
White	0.313 ±0.03	0.329 ±0.03

## 5.5 Absolute Maximum Rating

### 5.5.1 Absolute rating of environment

ITEM	Symbol	Min	Max	Unit	Note
Operating Temperature	TOP	0	50	°C	Note3
Surface of Glass temperature	TGS	0	65	[°C]	Note3 Note4
Operation Humidity	HOP	5	90	[%RH]	Note3
Storage Humidity	TST	-20	+60	[°C]	
Storage Humidity	HST	5	90	[%RH]	

\* Note

Note 3: Temperature and relative humidity range are shown as the below figure.

- 90% RH Max ( $T_a \leq 39^\circ\text{C}$ )
- Max wet-bulb temperature at  $39^\circ\text{C}$  or less ( $T_a \leq 39^\circ\text{C}$ )
- No condensation

Note 4 : Function Judged only

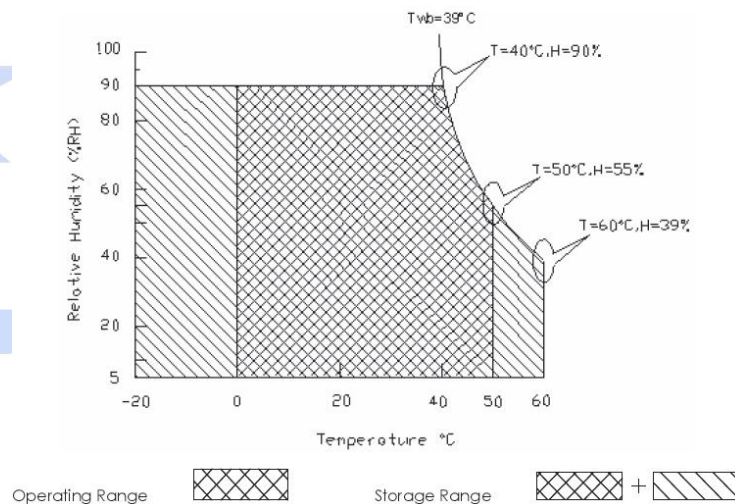

## 6. Visual Specification

### 6.1 Standard Mode & Display Size

Item	Specification	Note
Standard Mode	SXGA 1280* 1024 @ 60 [Hz]Resolution	Recommend Mode
Display Size	376.32 (H) x 301.06 (V)	Panel Active Visual Size

### 6.2 Standard Condition

Item	Specification	Note
Warm up Time	30 minutes after lighting	
Panel Face	None	

### 6.3 Screen image Stabilizing Time

Item	Specification	Note
Video Display Time	After turning power switch on, within 15 seconds	
Display Stability time	After turning power switch on, within 30 seconds	
AC input Voltage Stability	All specifications should be within 10% at 100~240V.	
Environments stability	All specifications should be within 2% at the operating temperature	

Note) All kinds of specification should be satisfied after 30 minutes from turning power switch on.

### 6.4 H & V Centering : 1280 × 1024, 60Hz

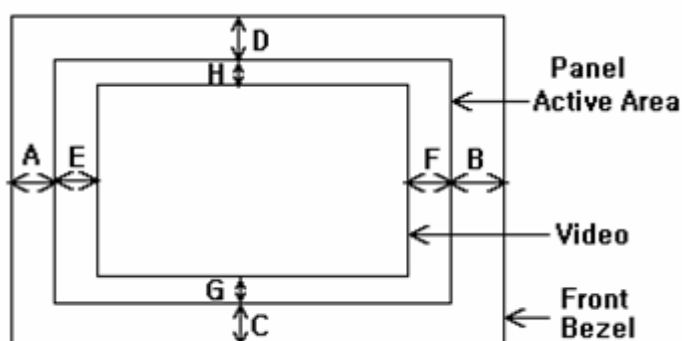

$$|A-B| \text{ and } |C-D| \leq 1.0[\text{mm}], |E-F| \text{ and } |G-H| \leq 1.0[\text{mm}]$$

**6.5 Focus**

Focus shall be inspected using the H character pattern with normal and reverse video, after setting by brightness 80 steps & contrast 80 steps.

All black/white and white/black transients shall be clearly visible on all points on the screen, and the focus performance shall be uniform across from a viewing distance of 50cm

**6.6 Color Spread**

The color must not spread on the panel, especially on the 4 side that panel and bezel contact each other.

**6.7 Noise, Jitter, Color lack, Screen shrink, and etc.**

During the operating there should not show on the screen like a noise, jitter, color lack, screen shrink, and etc.

**6.8 Residual Image**

After 10 hours aging at same pattern, there's no residual image after 2 hours aging.

**6.9 Crosstalk**

Any boundary line must not be seen on the white pattern.

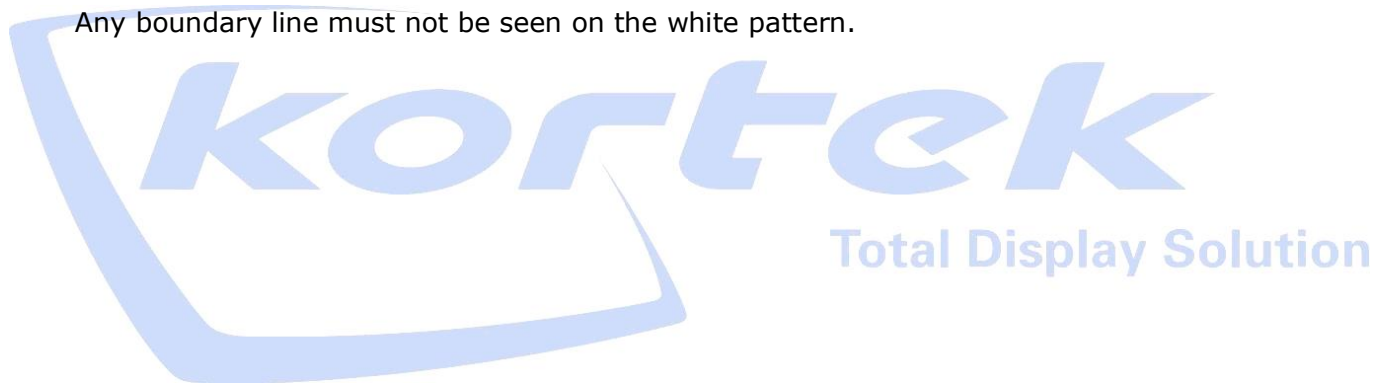

## 7. A/D Board

This board is main controller board and has following functions.

- Analog to Digital Conversion (R,G, B Gain Control)
- Scaling: input signal to fit Panel's resolution.
- Inverter Power control.
- DC to DC conversion to supply various power to each circuit

### 7.1 A/D Board Dimension

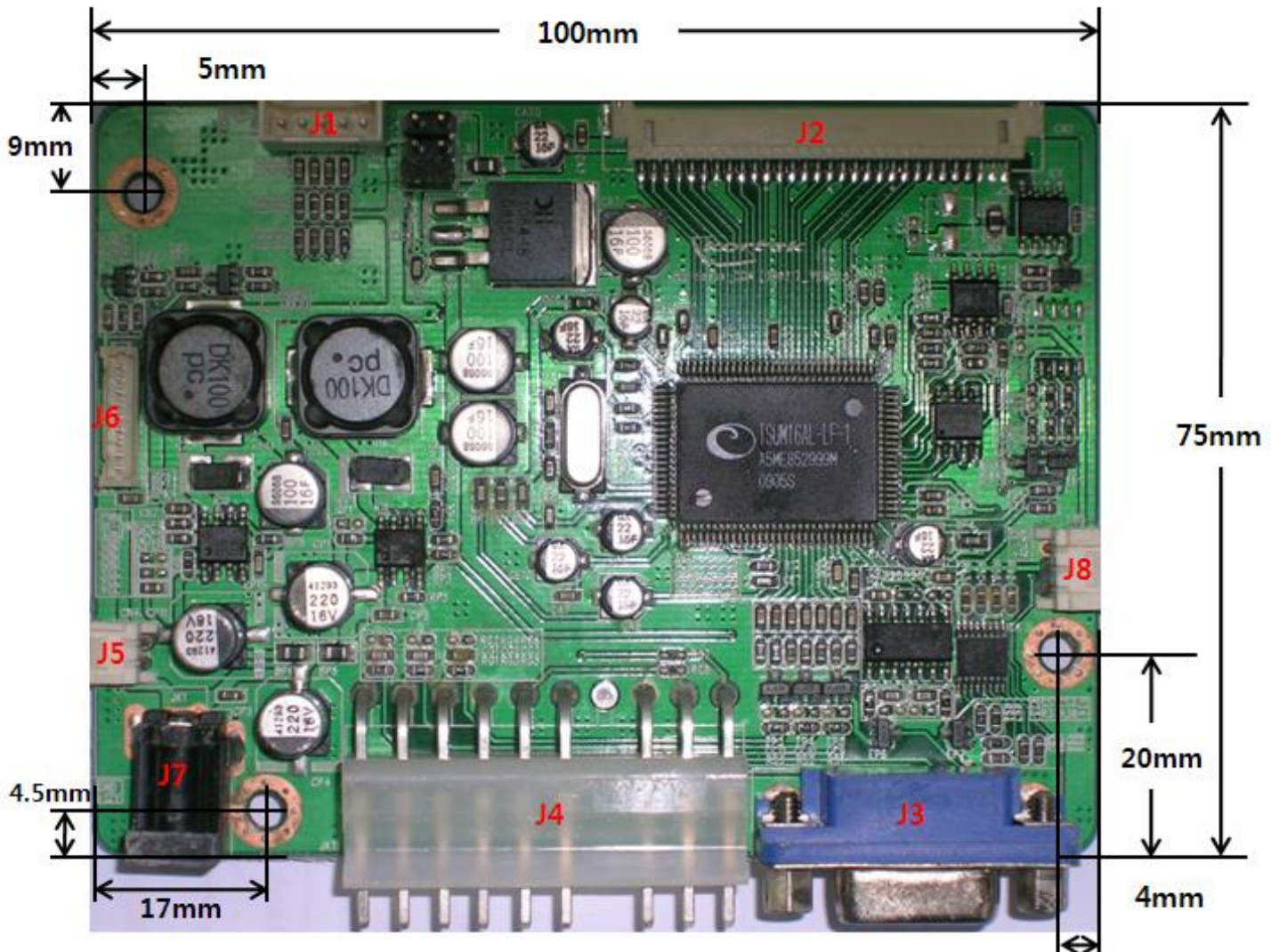

## 7.2 A/D Board connection

Symbol	Description	Parts Number	Manufacture
J1	OSD KEY		
J2	LVDS_OUT (Dual & Single)		
J3	RGB Input		
J4	10Pin CGA/EGA Analog (R,G,B) Input		
J5	2 Pin 12V Power		
J6	Inverter		
J7	DC Jack 12V Power		
J8	TOUCH Power		

### 7.2.1 J1 : OSD Key

Pin	Signal	Pin	Signal	Pin	Signal	Pin	Signal
1	MENU/ESC	2	SEL	3	GND	4	UP
5	DOWN						

### 7.2.2 J2 : LVDS\_OUT

Pin	Signal	Pin	Signal	Pin	Signal	Pin	Signal	Pin	Signal
1	TXE0M	7	GND	13	TXO0P	19	TXO2P	25	NC
2	TXE0P	8	TXECKM	14	GND	20	TXOCKM	26	NC
3	TXE1M	9	TXECKP	15	TXO1M	21	TXOCKP	27	NC
4	TXE1P	10	TXE3M	16	TXO1P	22	TXO3M	28	POWER(+VCC)
5	TXE2M	11	TXE3P	17	GND	23	TXO3P	29	POWER(+VCC)
6	TXE2P	12	TXO0M	18	TXO2M	24	GND	30	POWER(+VCC)

### 7.2.3 J3 : Analog R, G, B Input

Pin	Function	Pin	Function	Pin	Function
1	Red	6	Red ground	11	Reserved
2	Green	7	Green ground	12	DDC SDA
3	Blue	8	Blue ground	13	HSYNC (horizontal sync)
4	Reserved	9	-	14	VSYNC (vertical sync)
5	Ground	10	Sync Ground	15	DDC SCL



## 7.2.4 J4 : 10Pin CGA/EGA Connector

Pin	Signal	Pin	Signal
1	Horz -or Composite Sync.	6	Vertical+
2	Vertical-	7	Ground
3	Ground	8	BLUE
4	N.C	9	GREEN
5	Horz+	10	RED

## 7.2.5 J5 : Power 2pin

Pin	Signal	Pin	Signal	Pin	Signal
1	+12V	2	GND		

## 7.2.6 J6 : Inverter Control

Pin	Signal	Pin	Signal	Pin	Signal
1	A_DIM	2	INV ON/OFF	3	GND
4	GND	5	+12V	6	+12V

## 7.2.7 J7 : DC-Jack 2.5

## 7.2.8 J8 : Touch Power

Pin	Signal	Pin	Signal	Pin	Signal
1	GND	2	+5V	3	+12V

## 8. Converter Specification

### 8.1 Converter Dimension

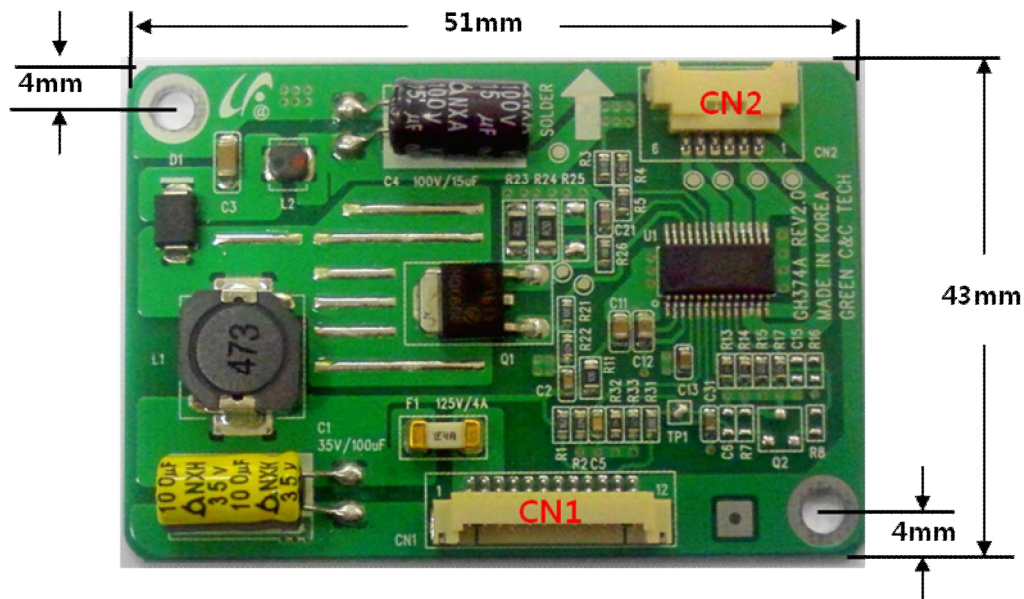

### 8.2 Input Connector CN1 : 12505 WR-12A00 (Yeon Ho)

Pin No	Symbol	Description
1,2,3	Vin	Input : +12V
4,5,7,8,12	GND	GND
11	Dim control	PWM Dimming
9	On/ Off	LED DRIVER ON/OFF Control
6,10	N.C	N.C

### 8.3 Output Connector : CN2

Pin No.	Symbol	Description
1	RTN1	Feedback 1(Return 1)
2	RTN2	Feedback 2(Return 2)
3,4	V_LED	System Output
5,	RTN3	Feedback 3(Return 3)
6	RTN4	Feedback 4(Return 4)

#### \* Caution:

When output connector is checked, the power should be turn off. Otherwise maybe be shocked electrically.

## 9. User Interface

### 9.1 OSD Key Dimension

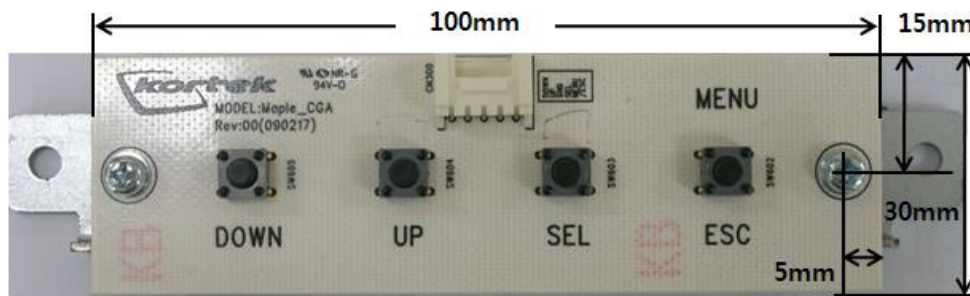

### 9.2 OSD Menu Structure

**There is a 'IMAGE ADJUST MENU' to support CGA/EGA Game Board at KORTEK monitor.**

#### 1. Easy Game Board Select

Step 1. Press 'UP' or 'DOWN' key.

Then, you'll get the message box like the right.

Step 2. At this message box, Select "AUTO-ADJUST".

Step 3. If you want 'Detail Image setting',  
press 'UP', 'DOWN' key.

\* Select item(s) by using SEL key.  
Change figure using DOWN/UP key.

IMAGE ADJUST MENU

```

RESET POSITION
AUTO-ADJUST
INPUT LEVEL  << STEP1 >>
AUTOCOLOR    PASS
H-POSITION   130
V-POSITION   10
H SIZE       780
V SIZE       230
CLOCK        50
PHASE        5
Res H:780 V:230 60Hz  GAME INDEX:28
MOVE         SELECT    EXIT
  
```

#### 2. Detail User setting

1) RESET POSITION – All position and Game Data Reset Default.

2) AUTO-ADJUST-Automatically Adjust Screen's Geometric.

2) INPUT LEVEL.

STEP1 – Input Video Level Pass Out.

STEP2 – If you want Input Video Level Middle Down.

STEP3 – If you want Input Video Level Max Down.

3) AUTOCOLOR – This function is for automatic setting of brightness & color from the input signals.

4) You can Adjust Horizontal Position.

5) You can Adjust Vertical Position.

6) You can Adjust Horizontal Size.

7) You can Adjust Vertical Size.

8) You can Adjust Clock (Frequency).

9) You can Adjust Phase.

REV.	DATE	ECO NO	DESCRIPTION OF CHANGE	DRAWN	APPROVAL
0	090618		INITIAL RELEASE-신규 품목 파생(CGA모형)	S.J	H.T KIM
△	091012	ECO 0910SJ01	MOUNT BK 장을 수정(REV.2) & COVER 인쇄 변경(REV.1)	S.J	H.T.KIM

### 10. Mechanical Specification

#### 10.1 Outline Dimension

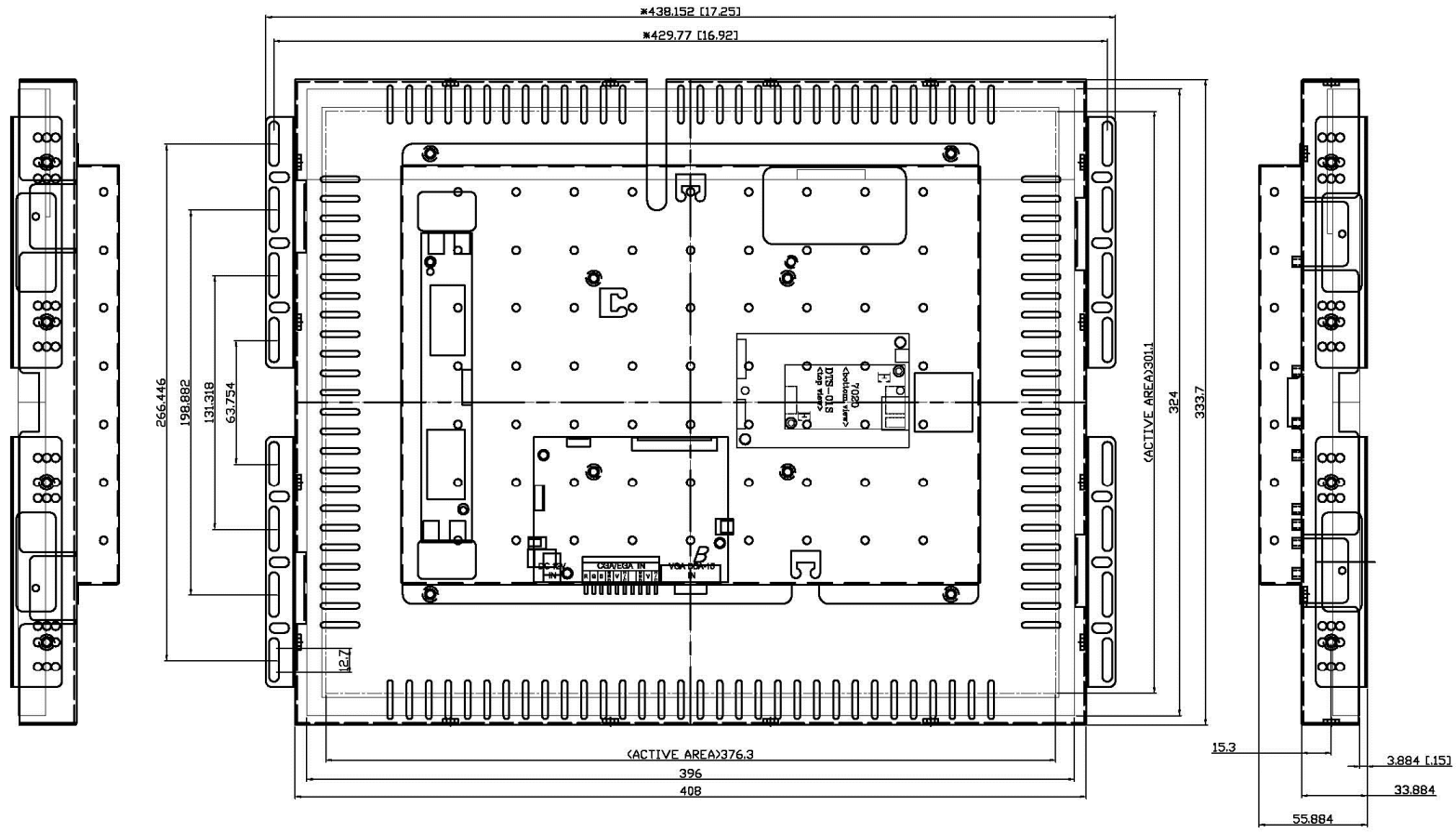

[19" BRACKET 체결방법]

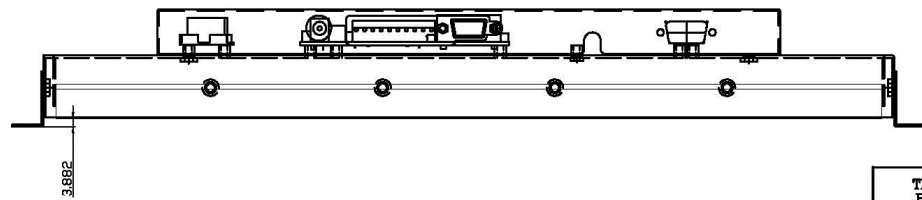
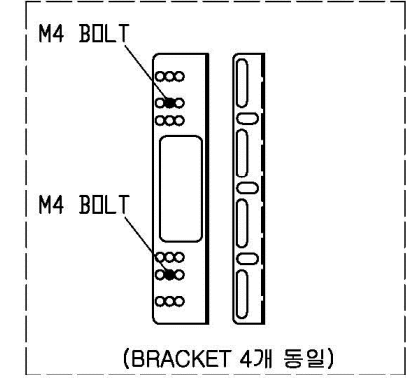

- NOTE**
1. Remove all sharp edges
  2. No harmful on the surface
  3. No inscribed ROUND, FILLET : R3
  4. Angular tolerance  $\pm 0.5^\circ$
  5. [dim] : User mount , \*(DIM) : Check point.

본 부품은 ROHS 규제 물질에 대한 코텍의 기준을 만족함.  
(THIS PART COMPLIES WITH KORTEK'S STANDARD FOR ROHS)

THIRD ANGLE PROJECTION	
DIMENSION TOLERANCES	
LENGTH	HOLE DIAMETERS
UNDER 49 ±0.1	UNDER 3.81 ±0.13
50 ~ 20.9 ±0.15	3.81 ~ 6.35 ±0.13
21.0 ~ 50.9 ±0.2	6.36 ~ 12.70 ±0.13
51.0 ~ 200.9 ±0.4	12.70 OVER ±0.25
201.0 ~ 500.0 ±0.6	ANGLE
500.0 OVER ±1.0	±0.3°

NO.	DESCRIPTION	Q'TY	DWG NO.	REMARK
4	[OSD BK-CGA]	1	60-219290314	
3	[MOUNT BK]	4	60-219290303	
2	[COVER]	1	60-219290312	
1	[BASE]	1	60-219290301	

DATE	NAME	TITLE	SCALE
090618	S.J	FRAME TFT LCD 19LCD GEN3_CGA HAPP [ASSEMBLY]	1:1

DESG.	CHEC.	APP.	REF.	DWG.NO	MATERIAL	UNIT	SHEET
090618	-	-	H.T KIM	60-219290310	-	mm	1/1

