

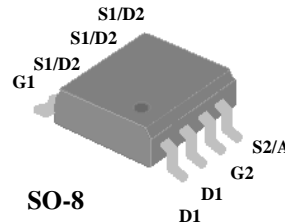

- ▼ Simple Drive Requirement
- ▼ DC-DC Converter Suitable
- ▼ Fast Switching Performance



CH-1	BV_{DSS}	30V
	$R_{DS(ON)}$	30m Ω
	I_D	5.7A
CH-2	BV_{DSS}	30V
	$R_{DS(ON)}$	22m Ω
	I_D	9.8A

Description

The Advanced Power MOSFETs from APEC provide the designer with the best combination of fast switching, ruggedized device design, low on-resistance and cost-effectiveness.

The SO-8 package is universally preferred for all commercial-industrial surface mount applications and suited for low voltage applications such as DC/DC converters.

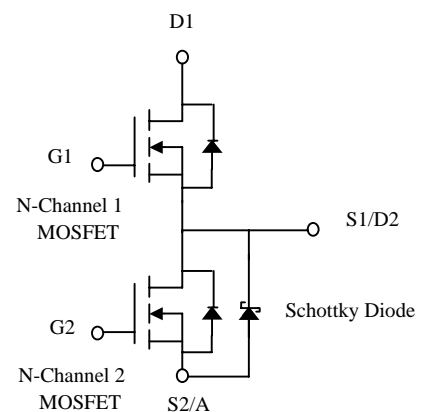

Absolute Maximum Ratings

Symbol	Parameter	Rating		Units
		Channel-1	Channel-2	
V_{DS}	Drain-Source Voltage	30	30	V
V_{GS}	Gate-Source Voltage	± 20	± 20	V
$I_D@T_A=25^\circ C$	Continuous Drain Current ³	5.7	9.8	A
$I_D@T_A=70^\circ C$	Continuous Drain Current ³	4.6	7.8	A
I_{DM}	Pulsed Drain Current ¹	20	30	A
$P_D@T_A=25^\circ C$	Total Power Dissipation	1.4	2.2	W
	Linear Derating Factor	0.01	0.02	W/ $^\circ C$
T_{STG}	Storage Temperature Range	-55 to 150		$^\circ C$
T_J	Operating Junction Temperature Range	-55 to 150		$^\circ C$

Thermal Data

Symbol	Parameter	Value		Units
		Typ.	Max.	
Rthj-a (CH-1)	Thermal Resistance Junction-ambient ³	70	90	$^\circ C/W$
Rthj-a (CH-2)	Thermal Resistance Junction-ambient ³	42	55	$^\circ C/W$



CH-1 Electrical Characteristics @ $T_j=25^\circ\text{C}$ (unless otherwise specified)

Symbol	Parameter	Test Conditions	Min.	Typ.	Max.	Units
BV_{DSS}	Drain-Source Breakdown Voltage	$V_{GS}=0V, I_D=250\mu A$	30	-	-	V
$\Delta BV_{DSS}/\Delta T_j$	Breakdown Voltage Temperature Coefficient	Reference to $25^\circ\text{C}, I_D=1\text{mA}$	-	0.01	-	V/ $^\circ\text{C}$
$R_{DS(ON)}$	Static Drain-Source On-Resistance ²	$V_{GS}=10V, I_D=5A$	-	-	30	m Ω
		$V_{GS}=4.5V, I_D=3A$	-	-	37	m Ω
$V_{GS(th)}$	Gate Threshold Voltage	$V_{DS}=V_{GS}, I_D=250\mu A$	1	-	3	V
g_{fs}	Forward Transconductance	$V_{DS}=10V, I_D=5A$	-	5.7	-	S
I_{DSS}	Drain-Source Leakage Current ($T_j=25^\circ\text{C}$)	$V_{DS}=30V, V_{GS}=0V$	-	-	1	μA
	Drain-Source Leakage Current ($T_j=70^\circ\text{C}$)	$V_{DS}=24V, V_{GS}=0V$	-	-	25	μA
I_{GSS}	Gate-Source Leakage	$V_{GS}=\pm 20V$	-	-	± 100	nA
Q_g	Total Gate Charge ²	$I_D=6A$	-	9	15	nC
Q_{gs}	Gate-Source Charge	$V_{DS}=24V$	-	2	-	nC
Q_{gd}	Gate-Drain ("Miller") Charge	$V_{GS}=4.5V$	-	6	-	nC
$t_{d(on)}$	Turn-on Delay Time ²	$V_{DS}=15V$	-	8	-	ns
t_r	Rise Time	$I_D=1A$	-	7	-	ns
$t_{d(off)}$	Turn-off Delay Time	$R_G=3.3\Omega, V_{GS}=10V$	-	19	-	ns
t_f	Fall Time	$R_D=15\Omega$	-	6	-	ns
C_{iss}	Input Capacitance	$V_{GS}=0V$	-	610	970	pF
C_{oss}	Output Capacitance	$V_{DS}=25V$	-	160	-	pF
C_{rss}	Reverse Transfer Capacitance	$f=1.0\text{MHz}$	-	120	-	pF
R_g	Gate Resistance	$f=1.0\text{MHz}$	-	1.6	-	Ω

Source-Drain Diode

Symbol	Parameter	Test Conditions	Min.	Typ.	Max.	Units
V_{SD}	Forward On Voltage ²	$I_S=1.2A, V_{GS}=0V$	-	-	1.2	V
t_{rr}	Reverse Recovery Time ²	$I_S=6A, V_{GS}=0V$	-	18	-	ns
Q_{rr}	Reverse Recovery Charge	$dI/dt=100A/\mu s$	-	11	-	nC

**CH-2 Electrical Characteristics @T_j=25°C(unless otherwise specified)**

Symbol	Parameter	Test Conditions	Min.	Typ.	Max.	Units
BV_{DSS}	Drain-Source Breakdown Voltage	$V_{GS}=0V, I_D=250\mu A$	30	-	-	V
$\Delta BV_{DSS}/\Delta T_j$	Breakdown Voltage Temperature Coefficient	Reference to 25°C, $I_D=1mA$	-	0.1	-	V/°C
$R_{DS(ON)}$	Static Drain-Source On-Resistance ²	$V_{GS}=10V, I_D=9A$	-	-	22	mΩ
		$V_{GS}=4.5V, I_D=7A$	-	-	29	mΩ
$V_{GS(th)}$	Gate Threshold Voltage	$V_{DS}=V_{GS}, I_D=250\mu A$	1	-	3	V
g_{fs}	Forward Transconductance	$V_{DS}=10V, I_D=9A$	-	11	-	S
I_{DSS}	Drain-Source Leakage Current (T _j =25°C)	$V_{DS}=30V, V_{GS}=0V$	-	-	100	μA
	Drain-Source Leakage Current (T _j =70°C)	$V_{DS}=24V, V_{GS}=0V$	-	-	1	mA
I_{GSS}	Gate-Source Leakage	$V_{GS}=\pm 20V$	-	-	±100	nA
Q_g	Total Gate Charge ²	$I_D=7A$	-	25	40	nC
Q_{gs}	Gate-Source Charge	$V_{DS}=24V$	-	4	-	nC
Q_{gd}	Gate-Drain ("Miller") Charge	$V_{GS}=10V$	-	7	-	nC
$t_{d(on)}$	Turn-on Delay Time ²	$V_{DS}=20V$	-	10	-	ns
t_r	Rise Time	$I_D=1A$	-	6	-	ns
$t_{d(off)}$	Turn-off Delay Time	$R_G=5.7\Omega, V_{GS}=10V$	-	26	-	ns
t_f	Fall Time	$R_D=20\Omega$	-	12	-	ns
C_{iss}	Input Capacitance	$V_{GS}=0V$	-	1170	1860	pF
C_{oss}	Output Capacitance	$V_{DS}=25V$	-	205	-	pF
C_{rss}	Reverse Transfer Capacitance	f=1.0MHz	-	142	-	pF
R_g	Gate Resistance	f=1.0MHz	-	1.7	-	Ω

Source-Drain Diode

Symbol	Parameter	Test Conditions	Min.	Typ.	Max.	Units
V_{SD}	Forward On Voltage ²	$I_S=2.6A, V_{GS}=0V$	-	-	1.2	V
t_{rr}	Reverse Recovery Time ²	$I_S=7A, V_{GS}=0V,$	-	21	-	ns
Q_{rr}	Reverse Recovery Charge	$di/dt=100A/\mu s$	-	16	-	nC

Notes:

- 1.Pulse width limited by Max. junction temperature.
- 2.Pulse width $\leq 300\mu s$, duty cycle $\leq 2\%$.
- 3.Surface mounted on 1 in² copper pad of FR4 board, t ≤ 10 sec.

**Schottky Specifications @ $T_j=25^\circ\text{C}$ (unless otherwise specified)**

Symbol	Parameter	Test Conditions	Min.	Typ.	Max.	Units
V_F	Forward Voltage Drop	$I_F=1.0\text{A}$	-	0.47	0.5	V
I_{rm}	Maximum Reverse Leakage Current	$V_r=30\text{V}$	-	0.004	0.2	mA
	Maximum Reverse Leakage Current	$V_r=30\text{V}, T_j=100^\circ\text{C}$	-	0.5	1	mA
C_T	Junction Capacitance	$V_r=10\text{V}$	-	66	-	pF



Channel-1

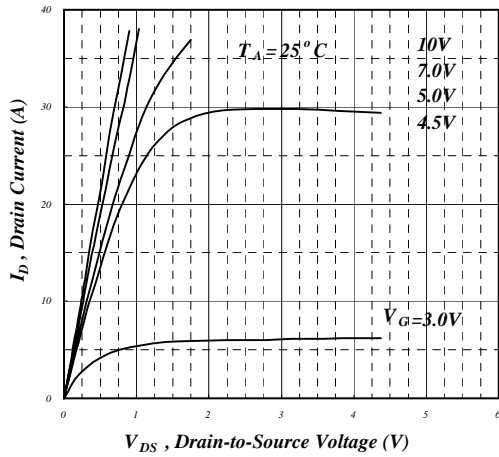

Fig 1. Typical Output Characteristics

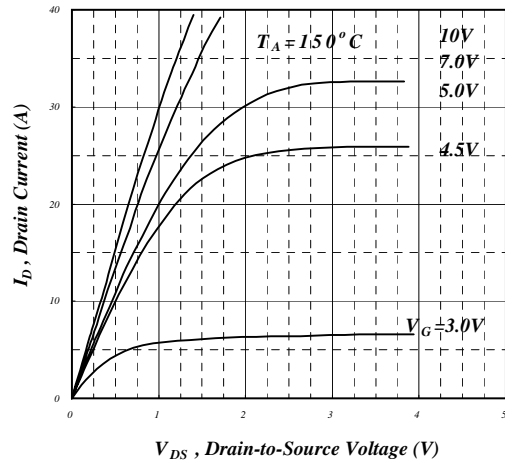

Fig 2. Typical Output Characteristics

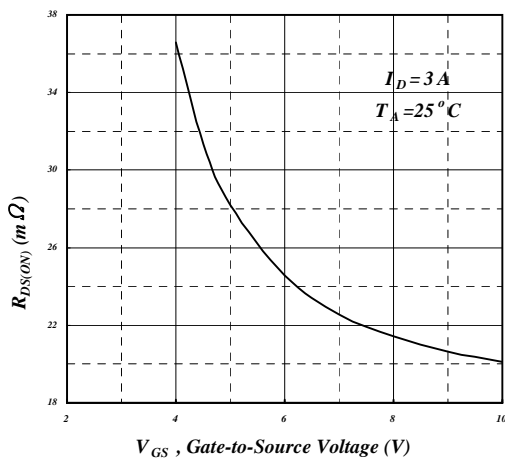

Fig 3. On-Resistance v.s. Gate Voltage

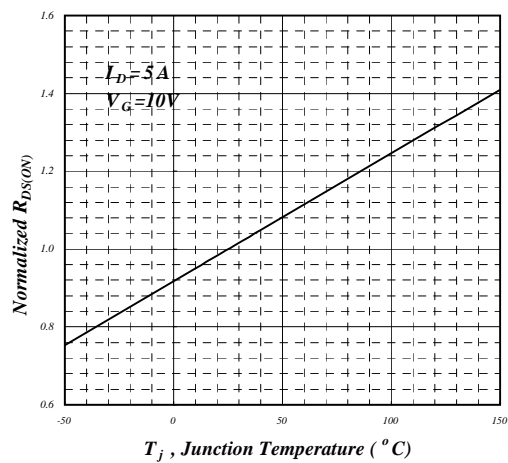

Fig 4. Normalized On-Resistance v.s. Junction Temperature

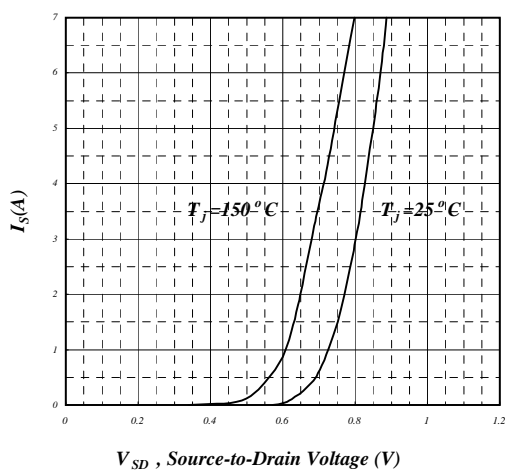

Fig 5. Forward Characteristic of Reverse Diode

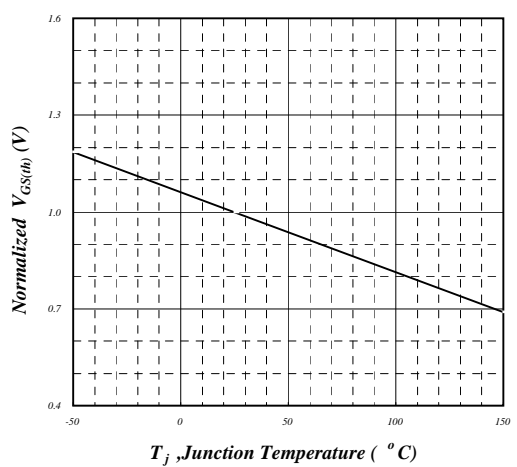

Fig 6. Gate Threshold Voltage v.s. Junction Temperature



Channel-1

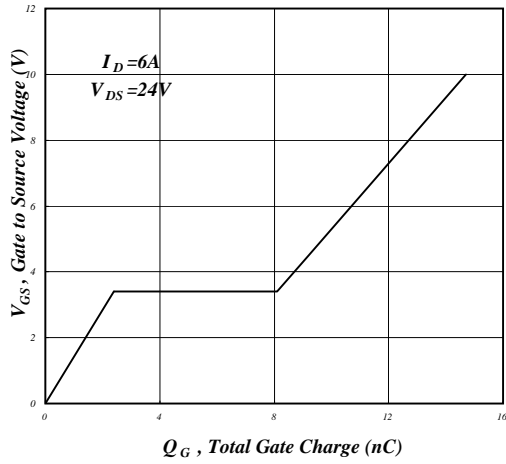

Fig 7. Gate Charge Characteristics

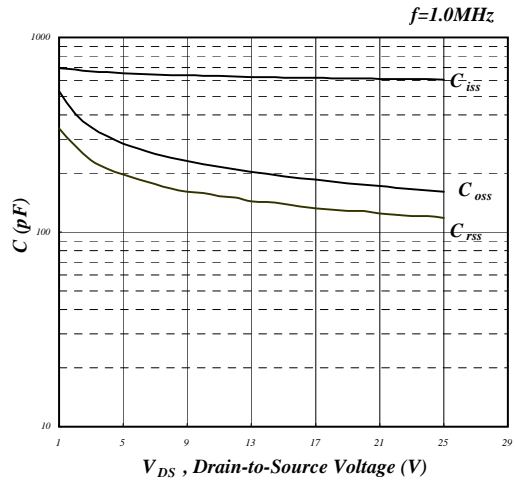

Fig 8. Typical Capacitance Characteristics

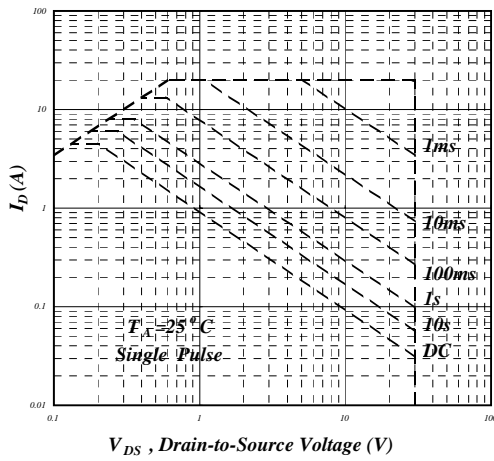

Fig 9. Maximum Safe Operating Area

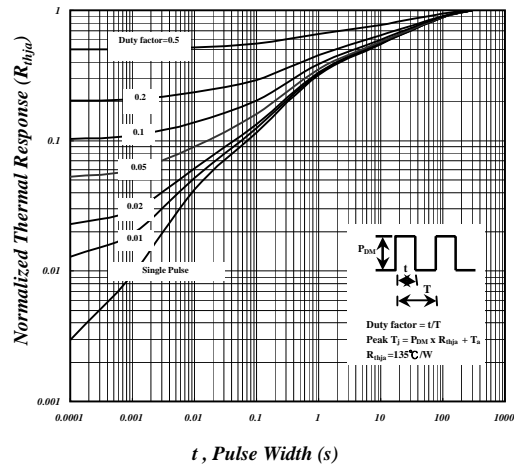

Fig 10. Effective Transient Thermal Impedance

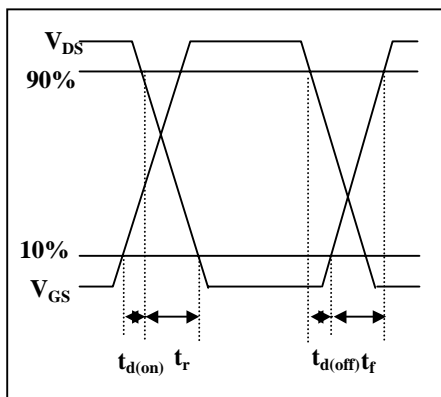

Fig 11. Switching Time Waveform

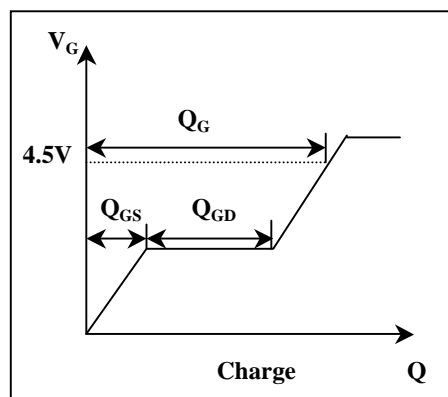

Fig 12. Gate Charge Waveform



AP6900GSM

Channel-2

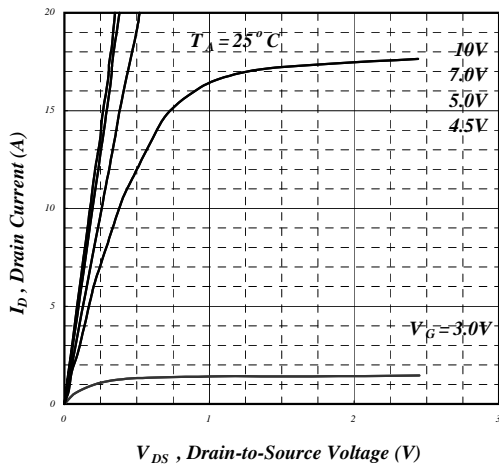

Fig 1. Typical Output Characteristics

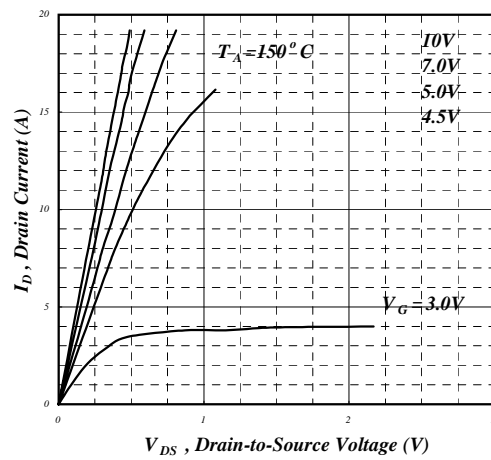

Fig 2. Typical Output Characteristics

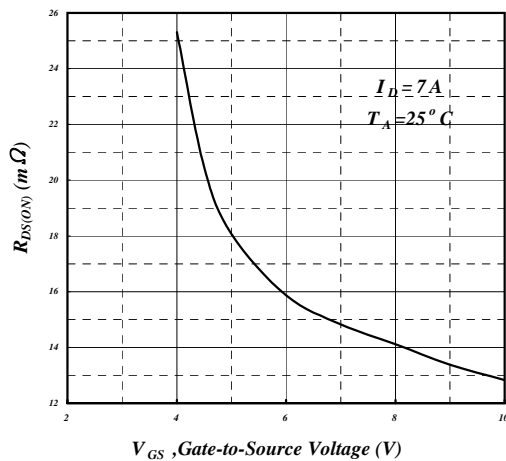

Fig 3. On-Resistance v.s. Gate Voltage

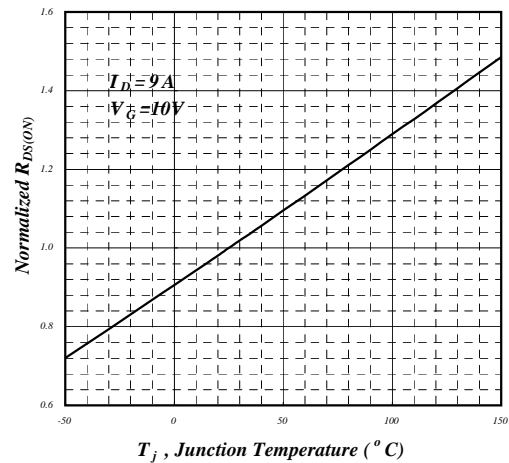

Fig 4. Normalized On-Resistance v.s. Junction Temperature

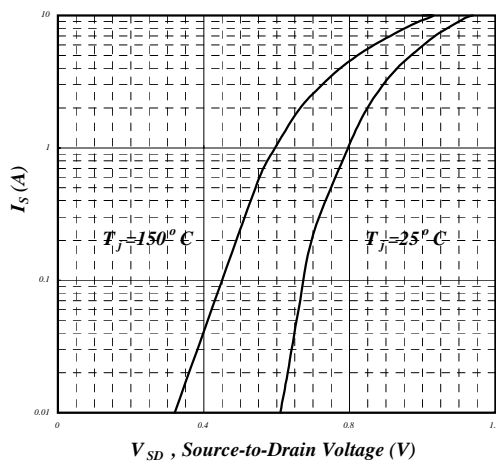

Fig 5. Forward Characteristic of Reverse Diode

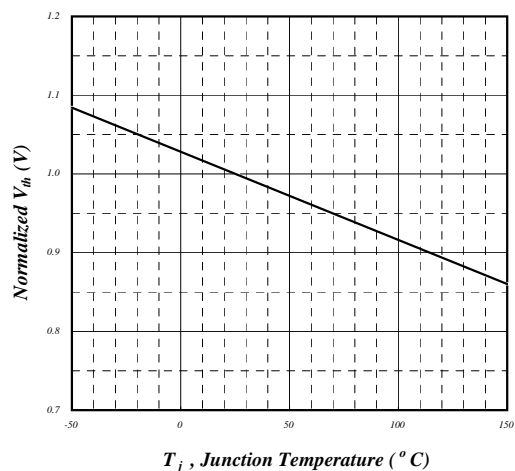

Fig 6. Gate Threshold Voltage v.s. Junction Temperature



Channel-2

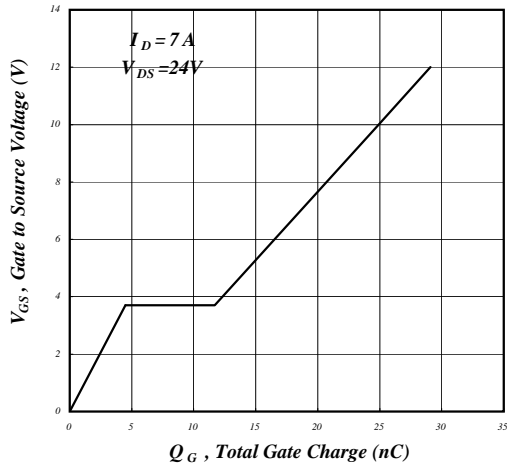

Fig 7. Gate Charge Characteristics

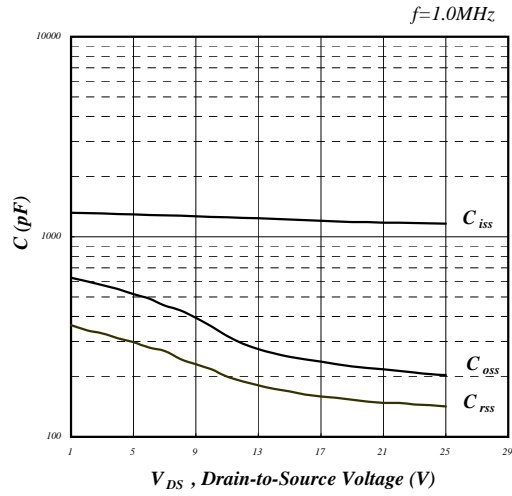

Fig 8. Typical Capacitance Characteristics

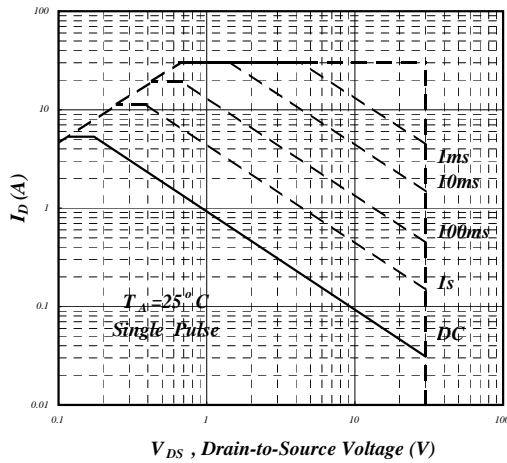

Fig 9. Maximum Safe Operating Area

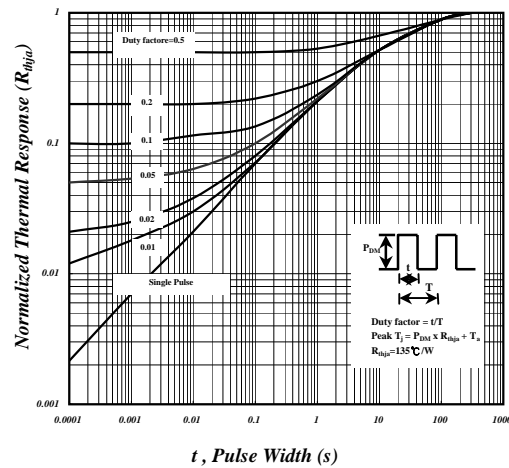

Fig 10. Effective Transient Thermal Impedance

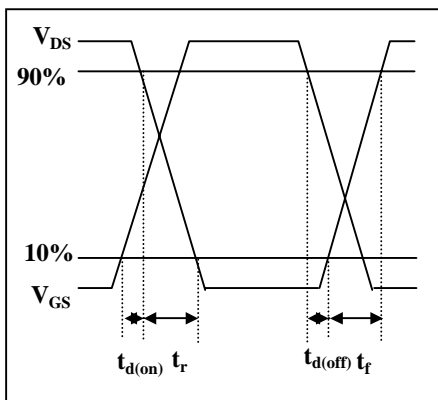

Fig 11. Switching Time Waveform

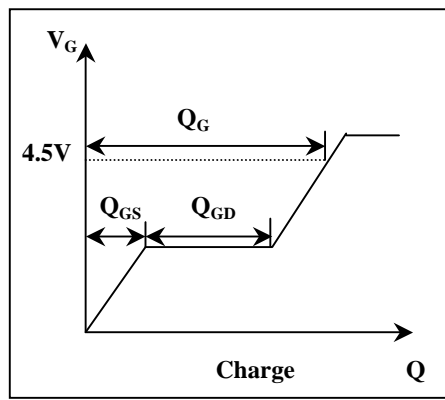

Fig 12. Gate Charge Waveform



Schottky

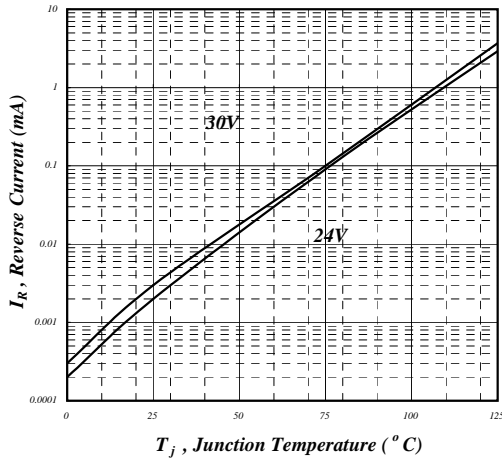

Fig 1. Reverse Current vs Junction Temperature

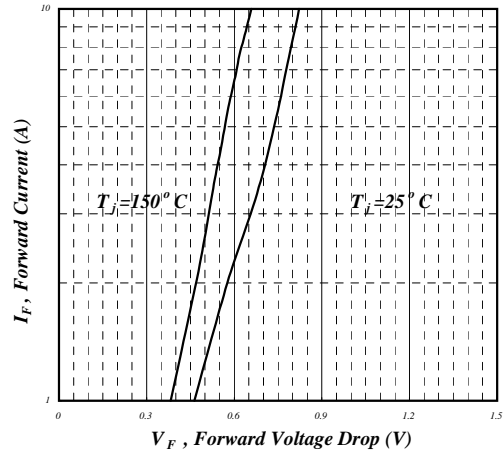

Fig 2. Typical Forward Characteristics

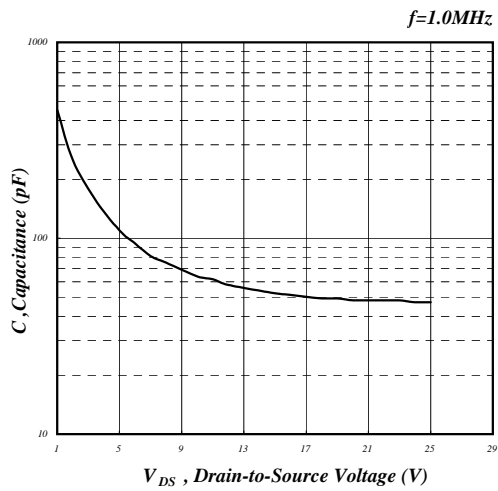

Fig 3. Typical Junction Capacitance