

RoHS Compliant Product
A suffix of "-C" specifies halogen free

DESCRIPTION

The SSD15N10 provide the designer with the best combination of fast switching. The TO-252 package is universally preferred for all commercial-industrial surface mount applications. The device is suited for charger, industrial and consumer environment.

FEATURES

- $R_{DS(on)} \leq 100m\Omega @ V_{GS} = 10V$
- Super high density cell design for extremely low $R_{DS(on)}$
- Exceptional on-resistance and maximum DC current capability

MARKING



PACKAGE INFORMATION

Package	MPQ	Leader Size
TO-252	2.5K	13' inch

TO-252(D-Pack)

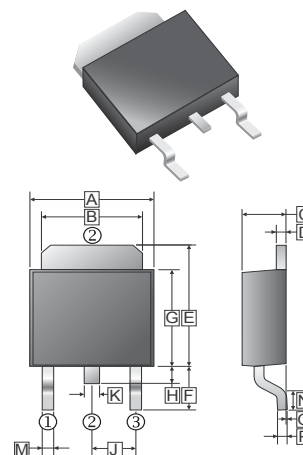

REF.	Millimeter		REF.	Millimeter	
	Min.	Max.		Min.	Max.
A	6.4	6.8	J	2.30	REF.
B	5.20	5.50	K	0.70	0.90
C	2.20	2.40	M	0.50	1.1
D	0.45	0.58	N	0.9	1.6
E	6.8	7.3	O	0	0.15
F	2.40	3.0	P	0.43	0.58
G	5.40	6.2			
H	0.8	1.20			

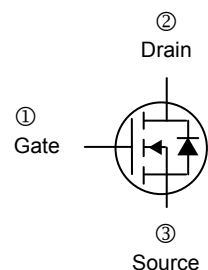

ABSOLUTE MAXIMUM RATINGS ($T_A = 25^\circ C$ unless otherwise specified)

Parameter	Symbol	Ratings	Unit
Drain-Source Voltage	V_{DS}	100	V
Gate-Source Voltage	V_{GS}	± 20	V
Continuous Drain Current	I_D	$T_C = 25^\circ C$	15
		$T_C = 70^\circ C$	13.8
Pulsed Drain Current ¹	I_{DM}	24	A
Power Dissipation	P_D	$T_C = 25^\circ C$	44.6
		$T_A = 25^\circ C$	2
Operating Junction and Storage Temperature Range	T_J, T_{STG}	-55 ~ 150	$^\circ C$
Thermal Resistance Ratings			
Maximum Thermal Resistance Junction-Ambient (PCB mount) ³	$R_{\theta JA}$	62.5	$^\circ C / W$
Maximum Thermal Resistance Junction-Case	$R_{\theta JC}$	2.8	$^\circ C / W$

ELECTRICAL CHARACTERISTICS ($T_A = 25^\circ\text{C}$ unless otherwise specified)

Parameter	Symbol	Min.	Typ.	Max.	Unit	Test conditions
Drain-Source Breakdown Voltage	BV_{DSS}	100	-	-	V	$V_{GS}=0, I_D=250\mu\text{A}$
Gate Threshold Voltage	$V_{GS(th)}$	1.0	-	2.5	V	$V_{DS}=V_{GS}, I_D=250\mu\text{A}$
Gate-Source Leakage Current	I_{GSS}	-	-	± 100	nA	$V_{GS} = \pm 20\text{V}$
Drain-Source Leakage Current	I_{DSS}	-	-	1	μA	$V_{DS}=80\text{V}, V_{GS}=0$
Static Drain-Source On-Resistance ²	$R_{DS(ON)}$	-	100	110	m Ω	$V_{GS}=10\text{V}, I_D=8\text{A}$
Total Gate Charge ²	Q_g	-	26.2	-	nC	$I_D=10\text{A}$ $V_{DS}=80\text{V}$ $V_{GS}=10\text{V}$
Gate-Source Charge	Q_{gs}	-	4.6	-		
Gate-Drain ("Miller") Charge	Q_{gd}	-	5.1	-		
Turn-on Delay Time ²	$T_{d(on)}$	-	4.2	-	nS	$V_{DS}=50\text{V}$ $I_D=10\text{A}$ $V_{GS}=10\text{V}$ $R_L=5\Omega$ $R_G=3.3\Omega$
Rise Time	T_r	-	8.2	-		
Turn-off Delay Time	$T_{d(off)}$	-	35.6	-		
Fall Time	T_f	-	9.6	-		
Input Capacitance	C_{iss}	-	1535	-	pF	$V_{GS}=0$ $V_{DS}=15\text{V}$ $f=1.0\text{MHz}$
Output Capacitance	C_{oss}	-	60	-		
Reverse Transfer Capacitance	C_{rss}	-	37	-		
Gate Resistance	R_g	-	2	-	Ω	$f=1.0\text{MHz}$
Source-Drain Diode						
Forward On Voltage ²	V_{SD}	-	-	1.2	V	$I_S=8.0\text{A}, V_{GS}=0\text{V}$

Notes:

1. Pulse width limited by maximum junction temperature.
2. Pulse test.
3. Surface Mounted on 1 in₂ copper pad of FR4 Board.

CHARACTERISTICS CURVE

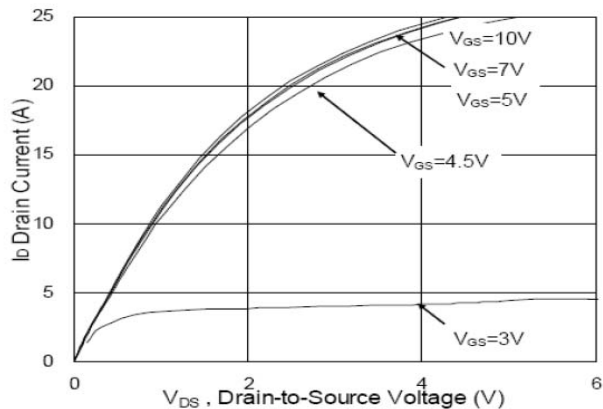

Fig 1. Typical Output Characteristics

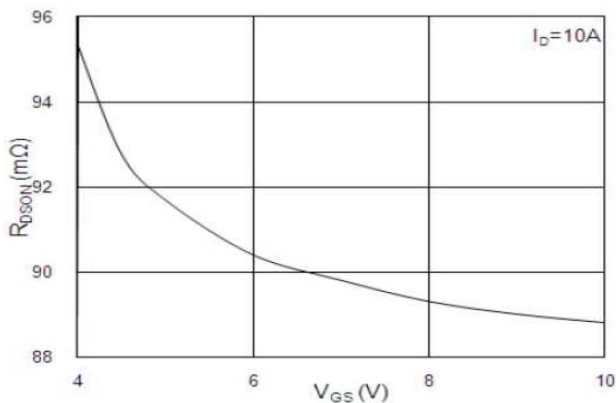

Fig 2. On-Resistance vs. Gate-Source

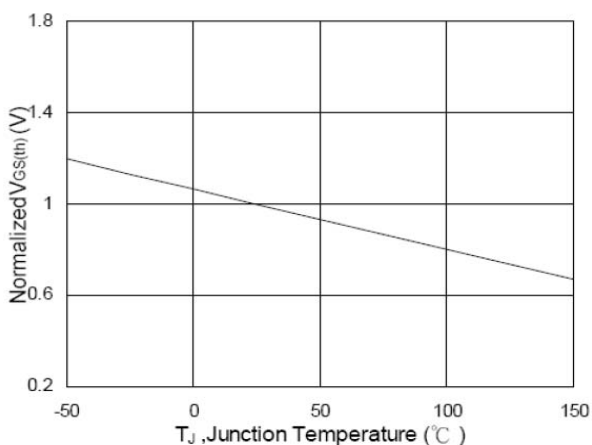

Fig 3. Gate Threshold Voltage vs. Junction Temperature

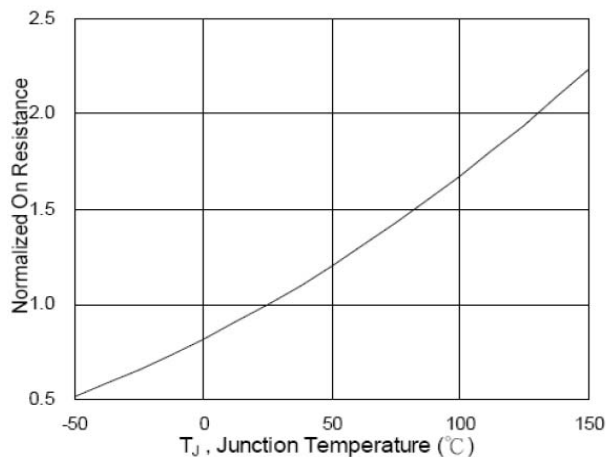

Fig 4. On-Resistance vs. Junction Temperature

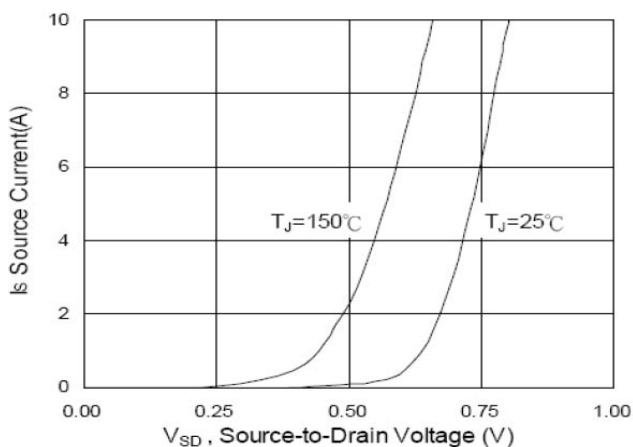

Fig 5. Forward Characteristics of Reverse Diode

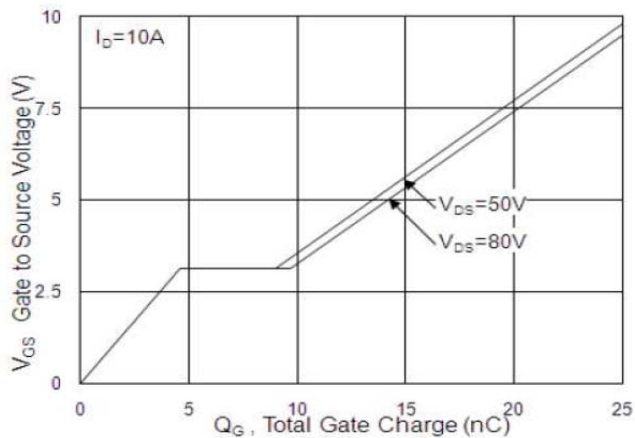

Fig 6. Gate Charge Characteristics

CHARACTERISTICS CURVE

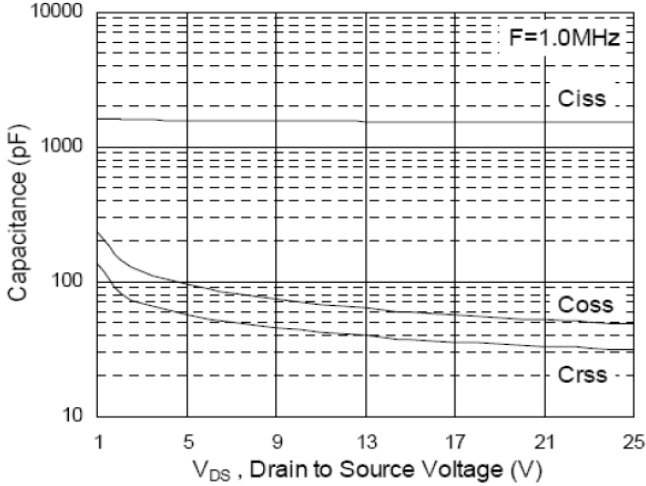

Fig 7. Typical Capacitance Characteristics

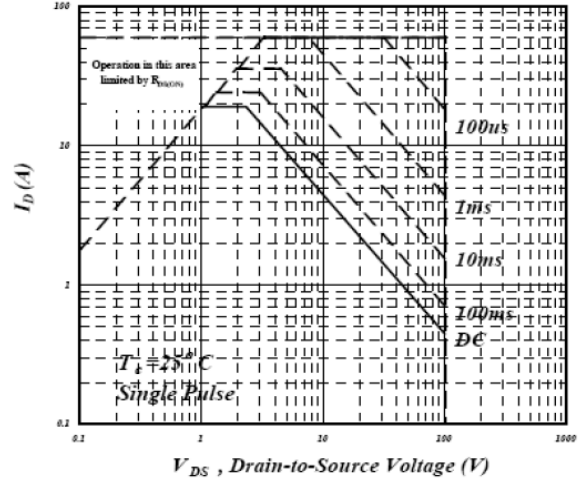

Fig 8. Maximum Safe Operating Area

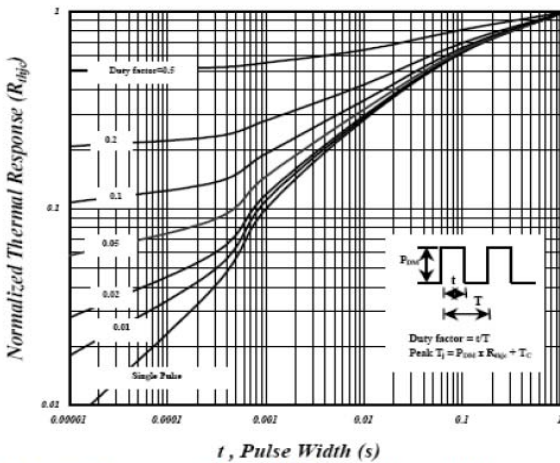

Fig 9. Normalized Transient Thermal Resistance vs. Pulse Width

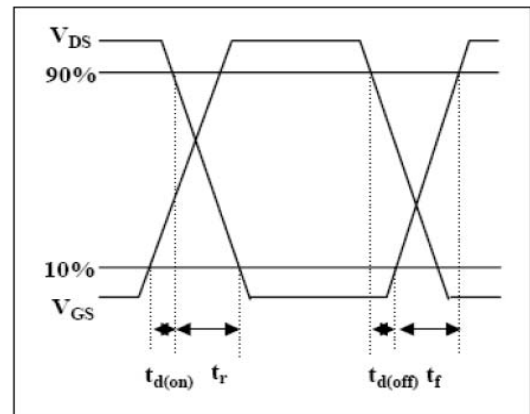

Fig 10. Switching Time Waveform

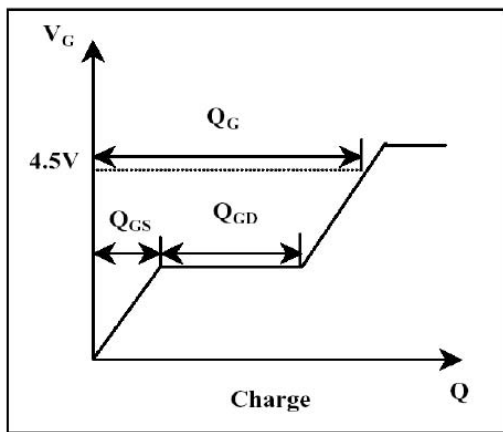

Fig 11. Gate Charge Waveform

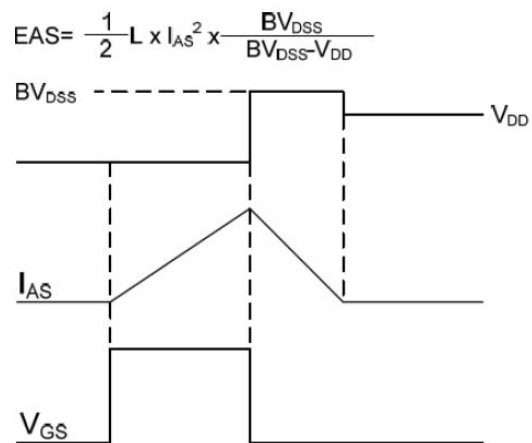

Fig 12. Unclamped Inductive Switching Waveform