

TSM5X5XP Series
TSM5X5XT Series
(With Pins)

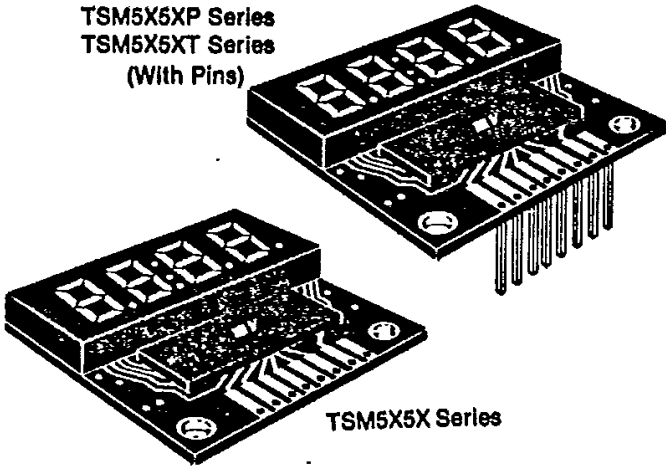

FEATURES

- Four 0.5" Digits
- Available With Colon
- LED Current Is Programmable
- Serial Data Input
- Chip Enable
- TTL Compatible
- Direct Current Drive (Non-multiplexed)
- Parts can be Marked with Appropriate Brightness Resistor Values

ABSOLUTE MAXIMUM RATINGS

V_{DD} : 12V
 V_{LED} : Figure 2
 Voltage at Any Other Pin: -0.3 to 12V
 Driver Chip
 Power Dissipation: 600mW Max.
 Operating Temperature: -20°C to 70°C
 Storage Temperature: -20°C to 70°C
 Lead Soldering Time
 @ 230°C: 5 sec. Max.

APPLICATIONS

- Microprocessor Controlled Display
- Digital Clock, Thermometer
- Instrument Readouts, Counter
- Voltmeter

BLOCK DIAGRAM

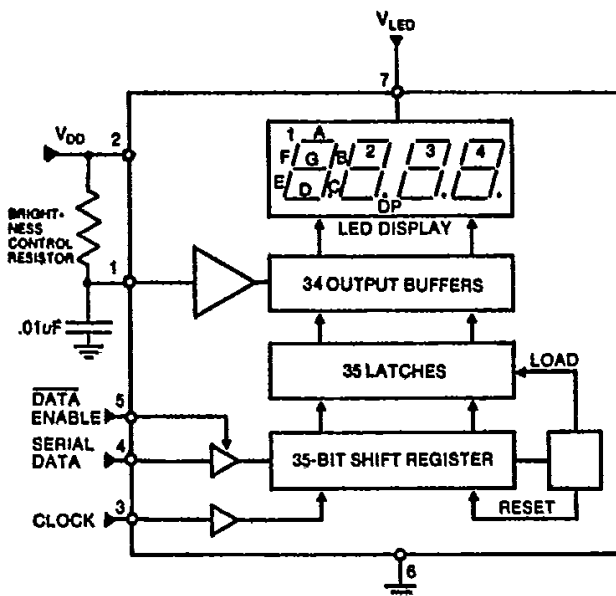

FIGURE 1—Block Diagram

DESCRIPTION

The TSM5X5X Series are 4-digit, 0.5" height LED displays with on-board serial data input/parallel data-out LED drivers designed to operate with minimal interface to the data source. Current drive to the LEDs is selected with an external resistor. The required resistor value can be indicated on the part.

Serial data transfer from the data source to the display driver is accomplished with three signals: data input, data enable, and clock. The data format consists of a leading "1" followed by 35 data bits. The 35 data bits are latched after the 36th bit is complete, thus providing non-multiplexed direct drive to the display. Outputs change only if the serial data bits differ from the previous time.

NUMERIC INTEGRATED DISPLAY

TSM5055, TSM5255 & TSM5755

19-36
17

ELECTRICAL CHARACTERISTICS

Symbol	Parameter	Conditions (TA = 25°C)	Min.	Typ.	Max.	Units
I _{DD}	V _{DD} Supply Current	V _{DD} = 11V			7.0	mA
I _{LED}	V _{LED} Supply Current/Segment	I _{BR} = 400µA		10		mA
V _{IL}	Input Voltage "0" Level		-0.3		0.8	V
V _{IH}	Input Voltage "1" Level		2.2		12	V
I _{BR}	Brightness Input Current		0		600	µA
V _{IN}	Brightness Input Voltage	I _{BR CONT} = 600µA	3.0		4.3	V
C _F	Input Clock Frequency				0.5	MHz
	Duty Cycle		40	50	60	%

OPTICAL CHARACTERISTICS

Symbol	Parameter	Conditions (TA = 25°C)	Min.	Typ.	Max.	Units
I _L	LED Segment Intensity	I _{BR CONT} = 400µA, V _{LED} = 3.5V				
	Red		0.1	0.2		mcd
	High Efficiency Red		0.5	0.8		mcd
	Green		0.6	1.5		mcd
λ _P	Intensity Matching	I _{BR CONT} = 400µA, V _{LED} = 3.5V V _{DD} = 5.0V, V _{LED} = 3.5V			±33	%
	Peak Wavelength					
	Red			655		nm
	High Efficiency Red			635		nm
	Green			565		nm

Note 1: Driver dissipation is given by P_{DR} = (V_{LED} - 1.7V) I_{LED} (Total) + (V_{DD} - 7.0mA) where V_{LED} is the LED supply Voltage, 1.7V is the minimum LED voltage drop and 7.0mA is the maximum current of the V_{DD} supply. For standard (655nm) red, use 1.8V as minimum LED voltage.

Note 2: Unless otherwise stated, all specifications apply with the following conditions: V_{DD} (supply) 4.75 to 11V, V_{LED} (supply) 3.5V.

Note 3: The brightness input is connected to V_{DD} with a resistor of the "Resistor Value" that is marked on the individual part.

PHYSICAL DIMENSIONS

PIN	FUNCTION
1	BRIGHTNESS CONTROL
2	V _{DD}
3	CLOCK
4	DATA
5	ENABLE
6	GROUND
7	V _{LED}

DIMENSIONS: $\frac{\text{INCHES}}{\text{(Millimeters)}}$

TOLERANCES: $\frac{0.XXX \pm 0.015}{(X.XX \pm 0.38)}$

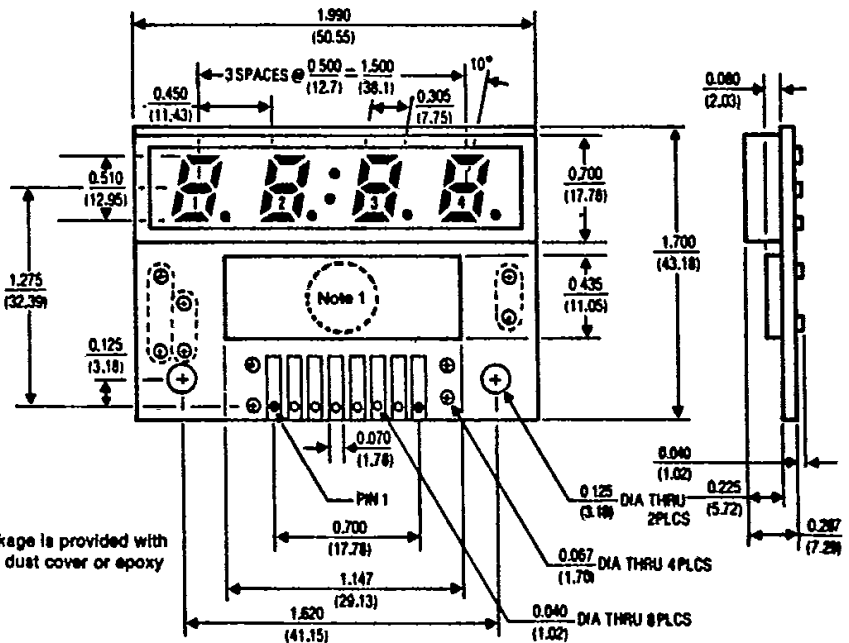

Note 1: Standard package is provided with a rectangular dust cover or epoxy blob.

"P" or "T" suffix for pins on PC board. Pins are 0.63" (16.00mm) beyond bottom of board x 0.025" (0.64mm) square.



THREE-FIVE SYSTEMS, INC.

Optoelectronics Group

TEL: 602-496-0035; FAX: 602-496-0168

THREE-FIVE SYSTEMS, LTD.

Swindon, U.K.

TEL: (0793) 616635; FAX: (0793) 614127

NUMERIC INTEGRATED DISPLAY

TSM5055, TSM5255 & TSM5755

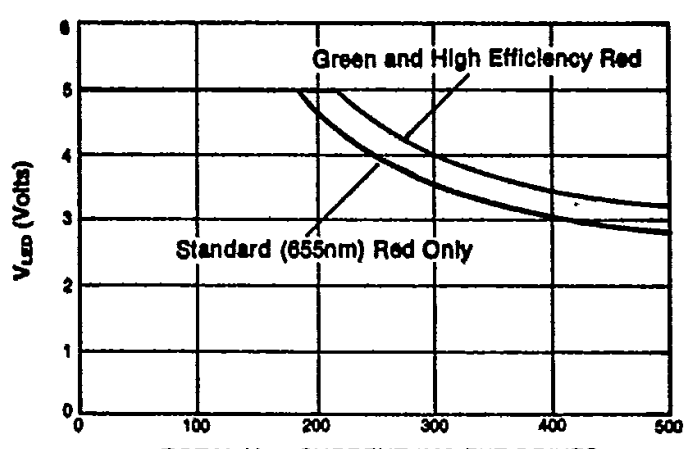

FIGURE 2—Max V_{LED} vs I_{LED} Circuit Per Figure 1

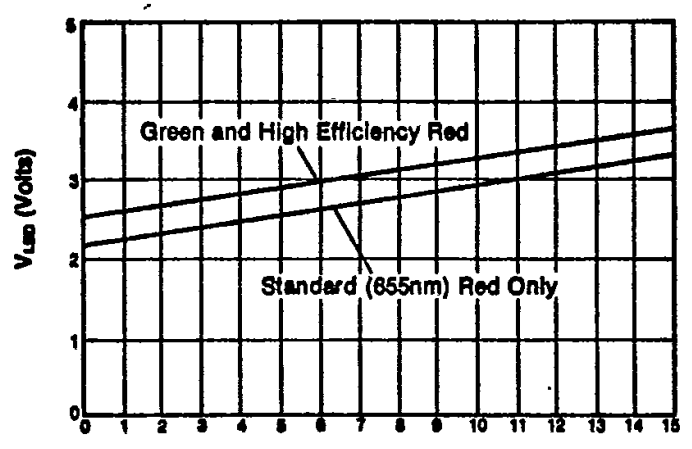

FIGURE 3—Min V_{LED} vs Drive Current Per LED

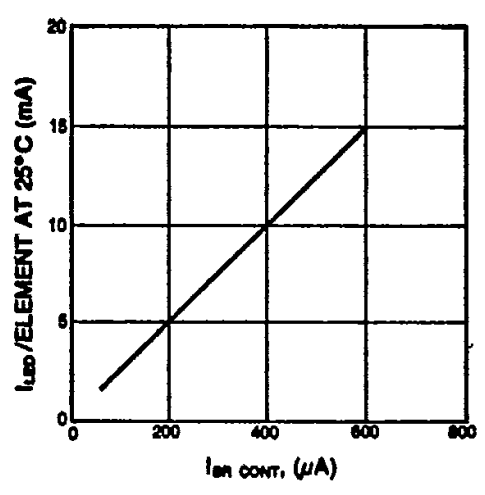

FIGURE 4—Typical LED Element Current vs Applied Brightness Control Element

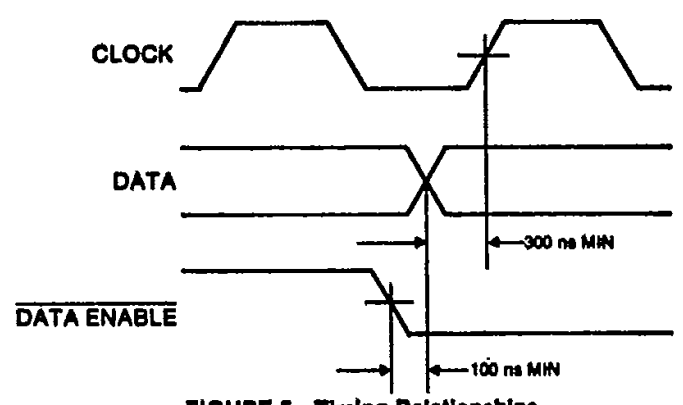

FIGURE 5—Timing Relationships

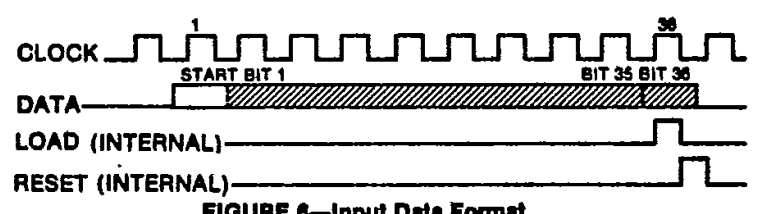

FIGURE 6—Input Data Format

FUNCTION DESCRIPTION

A block diagram is shown in Figure 1, and Figures 5 and 6 show the timing relationships and input data format. The start bit precedes the 35 data bits. At the 36th clock, a LOAD signal is generated synchronously with the high state of the clock, which loads the 35 bits in the shift registers into the latches. At the low state of the clock, a RESET signal is generated which clears all the shift registers for the next set of data. The shift registers are static master-slave configurations. There is no clear for the master portion of the first shift register, thus allowing continuous operation.

If the clock is not continuous, there must be a complete set of 36 clocks, otherwise the shift registers will not clear.

When the chips first powers ON, an internal power ON reset signal is generated which resets all registers

and all latches. The START bit and the first clock return the chip to its normal operation. To clear the display, load a "1" followed by 35 "0s". This blanks the LED and resets the driver IC.

Bit 1 is the first bit following the start bit and determines the drive current state of segment A of digit 1 (note: segment and digit designations are given in the block diagram of Figure 1). The bit sequence for all segments is shown in Table 1.

The LED element current is typically 25 times greater than the current into the brightness control pin as shown in Figure 4. Relationship of the LED current to LED supply voltage is shown in Figure 2.

A .01 μ F capacitor must be connected from the brightness control pin to the ground pin to prevent oscillations.



THREE-FIVE SYSTEMS, INC.
 Optoelectronics Group
 TEL: 602-496-0035; FAX: 602-496-0168

THREE-FIVE SYSTEMS, LTD.
 Swindon, U.K.

TEL: (0793) 618835; FAX: (0793) 614127

NUMERIC INTEGRATED DISPLAY

TSM5055, TSM5255 & TSM5755

BIT MAP

Bit #	Digit #	Segment	Bit #	Digit #	Segment
1	1	A	18	3	F
2	1	F	19	3	G
3	1	G	20	3	E
4	1	E	21	3	D
5	1	D	22	3	DP
6	1	DP	23	3	C
7	1	C	24	3	B
8	1	B	25	4	A
9	2	A	26	4	F
10	2	F	27	4	G
11	2	G	28	4	E
12	2	E	29	4	D
13	2	D	30	4	DP
14	2	DP	31	4	C
15	2	C	32	4	B
16	2	B	33	—	Up. Col.
17	3	A	34	—	Low. Col.

TABLE 1—Serial Input Sequence

OPTIONAL RESISTOR SELECTION

Resistor Value	Bin Code	Part Marked As	Containers Marked As
5.1K	BIN 1 (6.8K)	BIN 1 (6.8K) 5.1K	BIN 1 (6.8K)
5.6K	BIN 1 (6.8K)	BIN 1 (6.8K) 5.6K	BIN 1 (6.8K)
6.2K	BIN 1 (6.8K)	BIN 1 (6.8K) 6.2K	BIN 1 (6.8K)
6.8K	BIN 1 (6.8K)	BIN 1 (6.8K) 6.8K	BIN 1 (6.8K)
7.5K	BIN 2 (10K)	BIN 2 (10K) 7.5K	BIN 2 (10K)
8.2K	BIN 2 (10K)	BIN 2 (10K) 8.2K	BIN 2 (10K)
9.1K	BIN 2 (10K)	BIN 2 (10K) 9.1K	BIN 2 (10K)
10.0K	BIN 2 (10K)	BIN 2 (10K) 10.0K	BIN 2 (10K)
11.0K	BIN 3 (15K)	BIN 3 (15K) 11.0K	BIN 3 (15K)
13.0K	BIN 3 (15K)	BIN 3 (15K) 13.0K	BIN 3 (15K)
15.0K	BIN 3 (15K)	BIN 3 (15K) 15.0K	BIN 3 (15K)
16.0K	BIN 4 (20K)	BIN 4 (20K) 16.0K	BIN 4 (20K)
18.0K	BIN 4 (20K)	BIN 4 (20K) 18.0K	BIN 4 (20K)
20.0K	BIN 4 (20K)	BIN 4 (20K) 20.0K	BIN 4 (20K)

TABLE 2—Part Marking

Brightness Resistor Values—To use the resistor binning option, it is necessary to supply a current to the brightness current input. This is done by connecting an appropriate resistor between the brightness input and the VDD (5.0V) pin. This resistor is located on the customer's

mother board. Three-Five Systems, Inc. can test each part and mark it with the appropriate resistor value to be used. In addition, a "Customer Bin Code" is marked on the part. The relationship between "Resistor Value" and "Customer Bin Code" is given in Table 2.

ADDITIONAL ELECTRICAL CHARACTERISTICS (When the Specified Brightness Resistor is used)

Symbol	Parameter	Conditions (T _A = 25°C)	Min.	Typ.	Max.	Units
I _{LED}	V _{LED} Supply Current for Green and High Efficiency Red displays	V _{DD} = 5.25V, V _{LED} = 3.5V, all segs ON per the circuit of Figure 1.	240		340	mA
I _{LED}	V _{LED} Supply Current for standard (655nm) Red displays	V _{DD} = 5.25V, V _{LED} = 3.0V, all segs ON per the circuit of Figure 1.	240		340	mA

RECOMMENDED DISPLAY PROCESSING

The TSM5000 Series are constructed on a standard printed circuit board substrate and covered with a plastic reflector. The edge connector tab will withstand 230°C for 5 seconds. Permanent damage to the display will result if reflector temperature exceeds 70°C. Since the display is not hermetic, immersion of the entire package during flux and clean operation may cause condensation of flux or cleaner on the underside of the reflector. Only the edge

connectors should be immersed.

Rosin core solder, solid core solder, and low activity organic fluxes are recommended. Freon TF, Isopropanol, Methanol or Ethanol solvents are recommended only at room temperature and for short periods. The use of other solvents or elevated temperature use of the recommended solvents may cause permanent damage to the reflector or display.

ORDERING INFORMATION

"P" suffix for pins: 0.63" (16.00mm) beyond bottom of board x 0.025" (0.64mm) square. "T" suffix for pins and resistor binning. "B" suffix for resistor binning.

EXAMPLE:

TSM5055—Standard part, no pins. TSM5055P—Standard part, with pins, no resistor binning. TSM5055T—Standard part, with pins and resistor binning. TSM5055B—Standard part, no pins, with resistor binning.

The TSM5X55 Series is a CMOS device and normal precautions should be taken to avoid static damage.



THREE-FIVE SYSTEMS, INC.
 Optoelectronics Group
 TEL: 602-496-0035; FAX: 602-496-0188

THREE-FIVE SYSTEMS, LTD.
 Swindon, U.K.

TEL: (0793) 618835; FAX: (0793) 614127