

### FEATURES

**1. Forcibly guided contact structure**  
(EN50205 ClassA TÜV recognized)

**2. Slim profile (mm inch)**

Compact size with slim profile relay reduces substrate size.

[4-poles type] 40 (L)×13 (W)×24 (H)  
1.575 (L)×.512 (W)×.945 (H)

[6-poles type] 50 (L)×13 (W)×24 (H)  
1.969 (L)×.512 (W)×.945 (H)

**3. Built-in LED indication type available**

Built-in LED eliminates need for design and mounting of separate LED circuit. This cuts costs and saves labor.

**4. Fast response time is achieved (8 ms or less).**

Circuit is quickly opened to ensure safety.

**5. High shock resistance (Functional: Min. 200m/s<sup>2</sup>)**

Improved anti-shock properties meaning that the relay can be safely used in high shock and vibration environments such as in machine tools and other factory equipment.

**6. PC board sockets also available (4 and 6-pole)**

**7. Lineup also includes DIN terminal socket with finger protect construction. (4 and 6-pole)**

### TYPICAL APPLICATIONS

1. Machine tools
2. Robots
3. Safety PLCs
4. Circuits with stringent safety standard requirements such as those in motor vehicle production equipment.

RoHS Directive compatibility information  
<http://www.mew.co.jp/ac/e/environment/>

### ORDERING INFORMATION

SF **S** - [ ] - [ ] - [ ]

S: Slim type

Contact arrangement

2: 2 Form A 2 Form B

3: 3 Form A 1 Form B

4: 4 Form A 2 Form B

5: 5 Form A 1 Form B

6: 3 Form A 3 Form B

Operation indication

Nil: Without LED indication

L: With LED indication

Coil voltage

DC 12, 24, 48V

Note: Please inquire about other coil voltages.

## TYPES

## 1. Relay

Contact arrangement		Nominal voltage	Without LED indication	With LED indication
			Part No.	Part No.
4-poles	2 Form A 2 Form B	12 V DC	SFS2-DC12V	SFS2-L-DC12V
		24 V DC	SFS2-DC24V	SFS2-L-DC24V
		48 V DC	SFS2-DC48V	SFS2-L-DC48V
	3 Form A 1 Form B	12 V DC	SFS3-DC12V	SFS3-L-DC12V
		24 V DC	SFS3-DC24V	SFS3-L-DC24V
		48 V DC	SFS3-DC48V	SFS3-L-DC48V
6-poles	4 Form A 2 Form B	12 V DC	SFS4-DC12V	SFS4-L-DC12V
		24 V DC	SFS4-DC24V	SFS4-L-DC24V
		48 V DC	SFS4-DC48V	SFS4-L-DC48V
	5 Form A 1 Form B	12 V DC	SFS5-DC12V	SFS5-L-DC12V
		24 V DC	SFS5-DC24V	SFS5-L-DC24V
		48 V DC	SFS5-DC48V	SFS5-L-DC48V
	3 Form A 3 Form B	12 V DC	SFS6-DC12V	SFS6-L-DC12V
		24 V DC	SFS6-DC24V	SFS6-L-DC24V
		48 V DC	SFS6-DC48V	SFS6-L-DC48V

Standard packing: Carton: 50 pcs.; Case: 200 pcs.

## 2. Accessories

Type	No. of poles	Part No.
PC board sockets	4-pole	SFS4-PS
	6-pole	SFS6-PS
DIN terminal socket	4-pole	SFS4-SFD
	6-pole	SFS6-SFD

Standard packing: Carton: 10 pcs.; Case: 100 pcs.

## RATING

## 1. Coil data

Contact arrangement		Nominal voltage	Pick-up voltage (at 20°C 68°F)	Drop-out voltage (at 20°C 68°F)	Nominal operating current [±10%] (at 20°C 68°F)	Coil resistance [±10%] (at 20°C 68°F)	Nominal operating power (at 20°C 68°F)	Max. allowable voltage (at 20°C 68°F)
4-poles	2 Form A 2 Form B	12V DC	75%V or less of nominal voltage (Initial)	10%V or more of nominal voltage (Initial)	30mA	400Ω	Approx. 360mW	110%V of nominal voltage
		24V DC			15mA	1,600Ω		
		48V DC			7.5mA	6,400Ω		
	3 Form A 1 Form B	12V DC			30mA	400Ω		
		24V DC			15mA	1,600Ω		
		48V DC			7.5mA	6,400Ω		
6-poles	4 Form A 2 Form B	12V DC	75%V or less of nominal voltage (Initial)	10%V or more of nominal voltage (Initial)	41.7mA	288Ω	Approx. 500mW	110%V of nominal voltage
		24V DC			20.8mA	1,152Ω		
		48V DC			10.4mA	4,608Ω		
	5 Form A 1 Form B	12V DC			41.7mA	288Ω		
		24V DC			20.8mA	1,152Ω		
		48V DC			10.4mA	4,608Ω		
	3 Form A 3 Form B	12V DC			41.7mA	288Ω		
		24V DC			20.8mA	1,152Ω		
		48V DC			10.4mA	4,608Ω		

## 2. Specifications (relay)

Characteristics	Item	Specifications				
		4-pole		6-pole		
Contact	Contact arrangement	2 Form A 2 Form B	3 Form A 1 Form B	4 Form A 2 Form B	5 Form A 1 Form B	3 Form A 3 Form B
	Initial contact resistance, max	Max. 100 mΩ (By voltage drop 6 V DC 1A)				
	Contact material	Au flashed AgSnO <sub>2</sub> type				
Rating	Nominal switching capacity (resistive load)	6A 250V AC, 6A 30V DC				
	Max. switching power (resistive load)	1,500VA, 180W				
	Max. switching voltage	250V AC, 30V DC				
	Max. switching current	6 A (Reduce by 0.1 A/°C for temperatures 70 to 85°C.)				
	Min. switching capacity (Reference value)*1	1mA 5V DC				
	Nominal operating power	360mW	500mW			
Electrical characteristics	Insulation resistance (Initial)	Min. 1,000MΩ (at 500V DC) Measurement at same location as "Initial breakdown voltage" section.				
	Breakdown voltage (Initial)	Between open contacts	1,500 Vrms for 1 min. (Detection current: 10mA.)			
		Between contact sets	2,500 Vrms for 1 min. (Detection current: 10mA.); 7-8/9-10 between open contacts		2,500 Vrms for 1 min. (Detection current: 10mA.); 7-8/11-12 between open contacts 9-10/13-14 between open contacts 11-12/13-14 between open contacts	
			4,000 Vrms for 1 min. (Detection current: 10mA.); 3-4/5-6 between open contacts 3-4/7-8 between open contacts 5-6/9-10 between open contacts		4,000 Vrms for 1 min. (Detection current: 10mA.); 3-4/5-6 between open contacts 3-4/7-8 between open contacts 5-6/9-10 between open contacts	
			7-8/9-10 between open contacts			
	Between contact and coil	4,000 Vrms for 1min (Detection current: 10mA.)				
	Operate time (at 20°C 68°F)	Max. 20ms (Nominal voltage applied to the coil, excluding contact bounce time.)				
	Response time (at 20°C 68°F)*2	Max. 8ms (Nominal voltage applied to the coil, excluding contact bounce time.) (without diode)				
	Release time (at 20°C 68°F)	Max. 20ms (Nominal voltage applied to the coil, excluding contact bounce time.) (without diode)				
	Mechanical characteristics	Shock resistance	Functional	Min. 200 m/s <sup>2</sup> (Half-wave pulse of sine wave: 11 ms; detection time: 10μs.)		
Destructive			Min. 1,000 m/s <sup>2</sup> (Half-wave pulse of sine wave: 6 ms.)			
Vibration resistance		Functional	10 to 55 Hz at double amplitude of 1.5 mm (Detection time: 10μs.)			
		Destructive	10 to 55 Hz at double amplitude of 1.5 mm			
Expected life	Mechanical	Min. 10 <sup>7</sup> (at 180 cpm)				
	Electrical	250 V AC 6 A resistive load: Min. 10 <sup>5</sup> (at 20 cpm)		30 V DC 6 A resistive load: Min. 10 <sup>5</sup> (at 20 cpm)		
		250 V AC 1 A resistive load: Min. 5×10 <sup>5</sup> (at 30 cpm)		30 V DC 1 A resistive load: Min. 5×10 <sup>5</sup> (at 30 cpm)		
		[AC 15] 240 V AC 2 A inductive load: Min. 10 <sup>5</sup> (at 20 cpm, cosφ = 0.3)				
		[DC 13] 24 V DC 1 A inductive load: Min. 10 <sup>5</sup> (at 20 cpm, L/R = 48 ms)				
Conditions	Conditions for operation, transport and storage*3	Ambient temperature: -40°C to +85°C -40°F to +185°F Humidity: 5 to 85% R.H. (Not freezing and condensing at low temperature)				
	Max. Operating speed	20 cpm (at max. rating)				
Unit weight		Approx. 20 g .71 oz		Approx. 23 g .81 oz		

Notes: \*1 This value can change due to the switching frequency, environmental conditions, and desired reliability level, therefore it is recommended to check this with the actual load.

\*2 Response time is the time after the coil voltage turns off until the time when "a" contact turns off.

\*3 The upper operation ambient temperature limit is the maximum temperature that can satisfy the coil temperature rise value.

Refer to 6. Conditions for operation, transport and storage mentioned in AMBIENT ENVIRONMENT.

## 3. Specifications (PC board sockets/DIN terminal socket)

Item	Specifications
Max. carrying current	6 A (Reduce by 0.1 A/°C for temperatures 70 to 85°C.)
Initial breakdown voltage	Between each terminal: 2,500 Vrms for 1 min. (Detection current: 10mA)
Initial insulation resistance	Min. 1,000MΩ (at 500V DC) Measurement at same location as "Initial breakdown voltage" section.

## REFERENCE DATA

### 1. Operate/response/release time

Tested sample: SFS4-DC24V (4 Form A/2 Form B), 20pcs. (a contacts: 80, b contacts: 40)

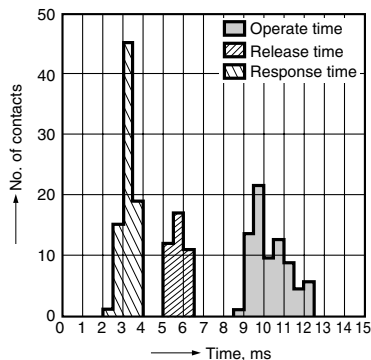

### 2. Coil temperature rise

Tested sample: SFS4-DC24V (4 Form A/2 Form B), 3pcs.

Measured portion: Inside the coil  
Ambient temperature: Room temperature  
(27°C 80.6°F), 70°C 158°F, 85°C 185°F

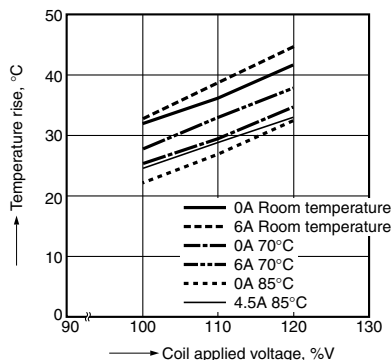

### 3. Malfunctional shock

Tested sample: SFS4-DC24V (4 Form A/2 Form B), 3pcs.

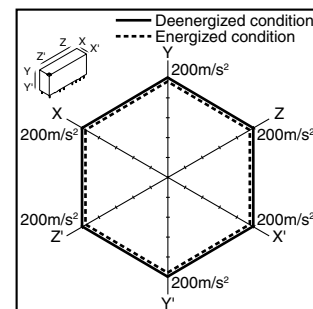

### 4. Max, switching capacity

(2 Form A/2 Form B type)

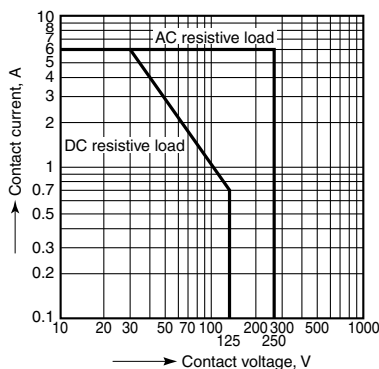

## Other contact gaps when contacts are welded

Sample: SFS4-DC24V (4 Form A/2 Form B)

The table below shows the state of the other contacts.

In case of form "NO" contact weld the coil applied voltage is 0 V.

In case of form "NC" contact weld the coil applied voltage is nominal.

		State of other contacts					
		3-4 (NC)	5-6 (NC)	7-8 (NO)	9-10 (NO)	11-12 (NO)	13-14 (NO)
Welded contact No.	3-4 (NC)			>0.5	>0.5	>0.5	>0.5
	5-6 (NC)			>0.5	>0.5	>0.5	>0.5
	7-8 (NO)	>0.5	>0.5				
	9-10 (NO)	>0.5	>0.5				
	11-12 (NO)	>0.5	>0.5				
	13-14 (NO)	>0.5	>0.5				

>0.5: contact gap is kept at min. 0.5 mm .020inch

Empty cells: either ON or OFF

Note: Contact gaps are shown at the initial state.

If the contact transfer is caused by load switching, it is necessary to check the actual loading.

**DIMENSIONS** (Unit: mm inch)

**1. 4-pole (2 Form A 2 Form B, 3 Form A 1 Form B)**

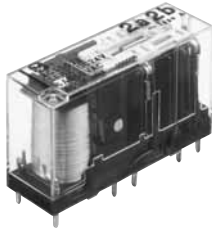

External dimensions

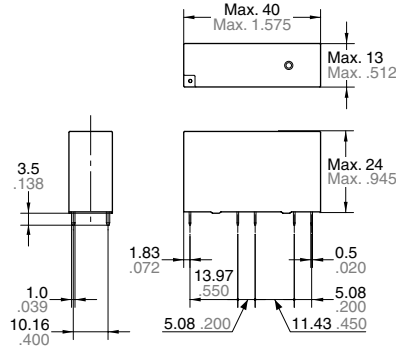

PC board pattern (Bottom view)

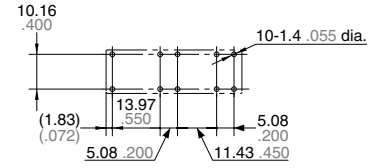

Tolerance:  $\pm 0.1 \pm 0.004$

General tolerance:  $\pm 0.3 \pm 0.012$

Schematic (Bottom view)

Standard

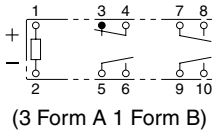
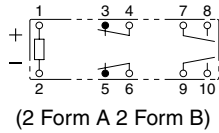

With LED indication

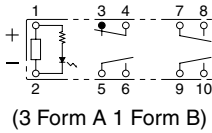
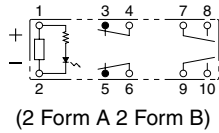

**2. 6-pole (4 Form A 2 Form B, 5 Form A 1 Form B, 3 Form A 3 Form B)**

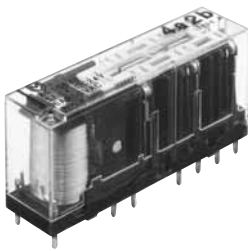

External dimensions

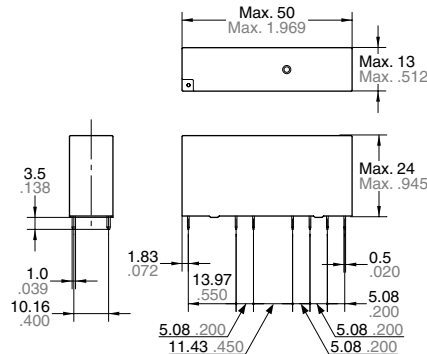

PC board pattern (Bottom view)

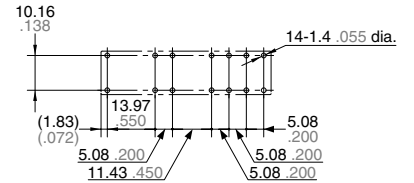

Tolerance:  $\pm 0.1 \pm 0.004$

General tolerance:  $\pm 0.3 \pm 0.012$

Schematic (Bottom view)

Standard

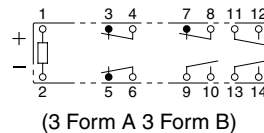
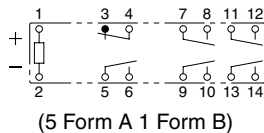
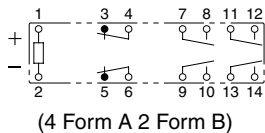

With LED indication

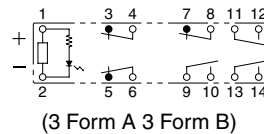
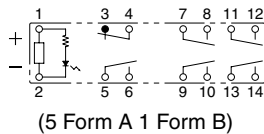
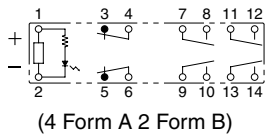

## 3. PC board sockets (4-pole)

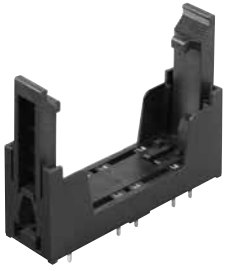

External dimensions

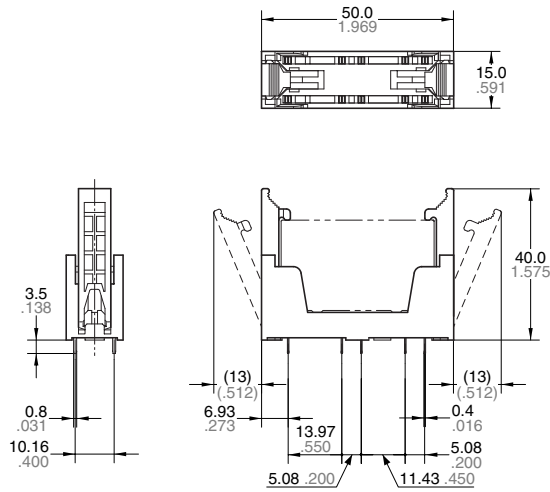

PC board pattern (Bottom view)

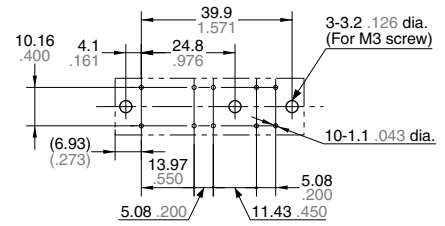

Tolerance:  $\pm 0.1 \pm .004$

General tolerance:  $\pm 0.3 \pm .012$

Schematic (Bottom view)

Standard

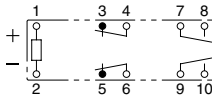

(When 2 Form A 2 Form B mounted)

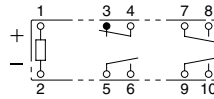

(When 3 Form A 1 Form B mounted)

With LED indication

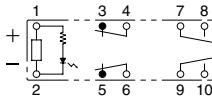

(When 2 Form A 2 Form B mounted)

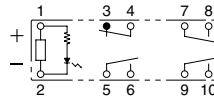

(When 3 Form A 1 Form B mounted)

## 4. PC board sockets (6-pole)

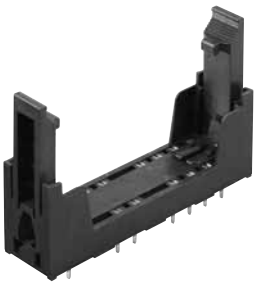

External dimensions

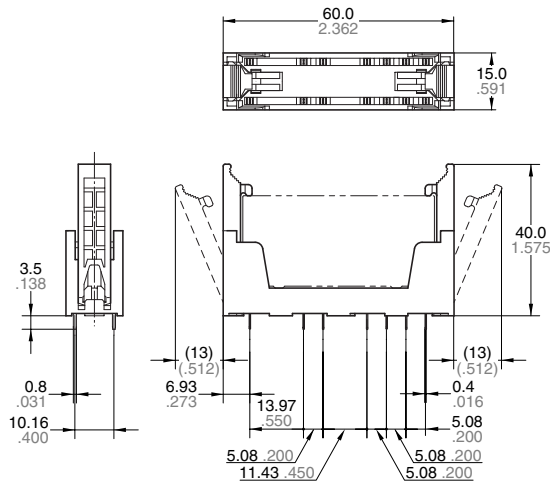

PC board pattern (Bottom view)

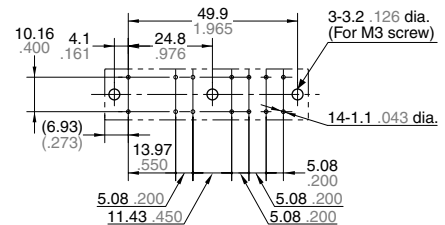

Tolerance:  $\pm 0.1 \pm .004$

General tolerance:  $\pm 0.3 \pm .012$

Schematic (Bottom view)

Standard

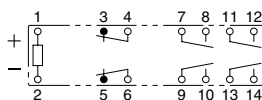

(When 4 Form A 2 Form B mounted)

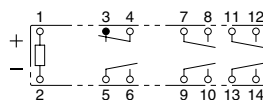

(When 5 Form A 1 Form B mounted)

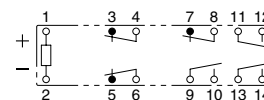

(When 3 Form A 3 Form B mounted)

With LED indication

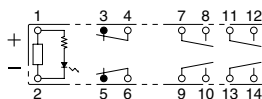

(When 4 Form A 2 Form B mounted)

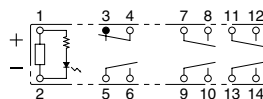

(When 5 Form A 1 Form B mounted)

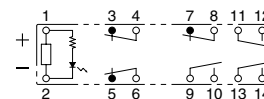

(When 3 Form A 3 Form B mounted)

5. DIN terminal socket (4-pole)

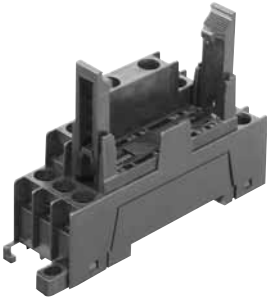

External dimensions

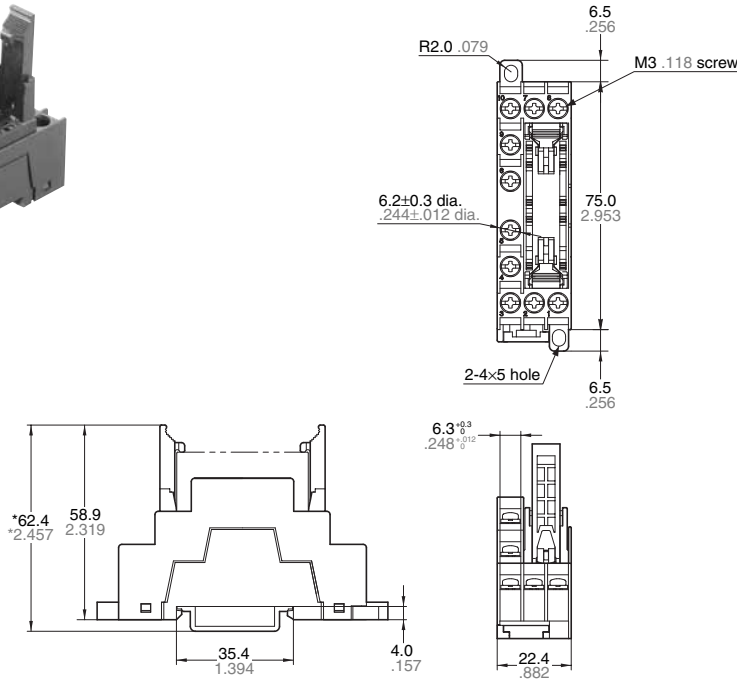

General tolerance:  $\pm 0.5 \pm 0.020$

\* Reference value (when using DIN rail ATA48011)

Note: Round terminals cannot be used with DIN terminal sockets.

Mounting hole dimensions

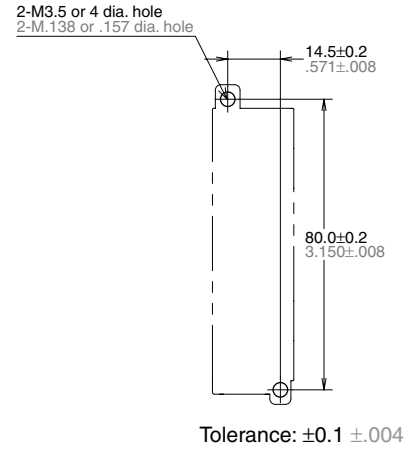

Schematic (Top view)

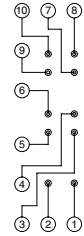

6. DIN terminal socket (6-pole)



External dimensions

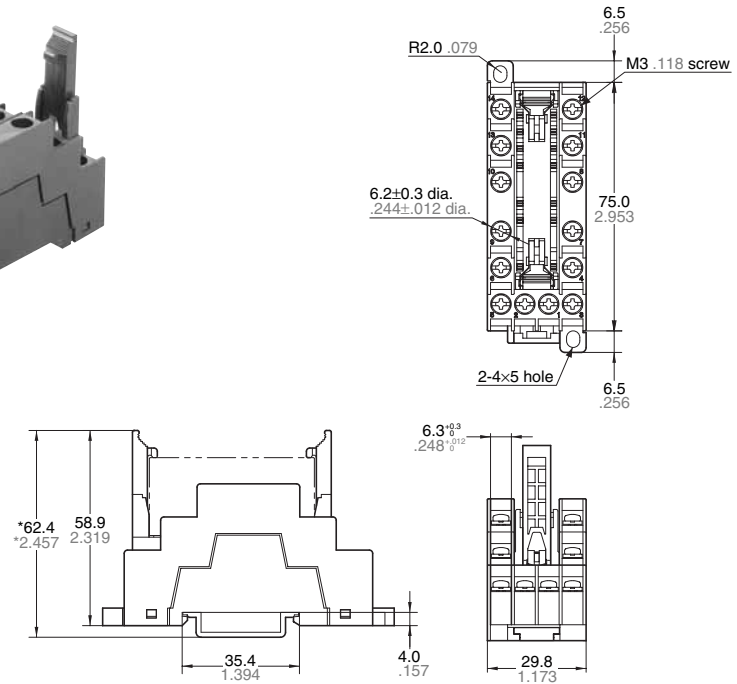

General tolerance:  $\pm 0.5 \pm 0.020$

\* Reference value (when using DIN rail ATA48011)

Note: Round terminals cannot be used with DIN terminal sockets.

Mounting hole dimensions

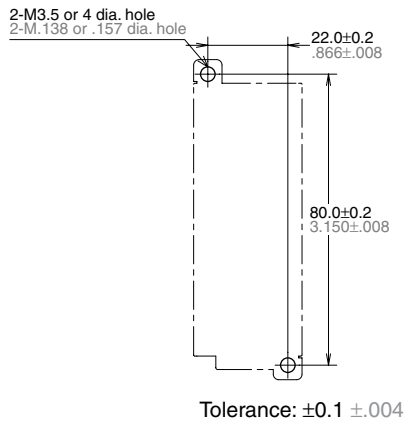

Schematic (Top view)

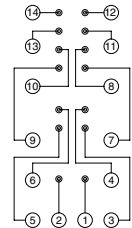

## NOTES

**1. Coil operating power**

Pure DC current should be applied to the coil. The wave form should be rectangular. If it includes ripple, the ripple factor should be less than 5%. However, check it with the actual circuit since the characteristics may be slightly different.

**2. Coil connection**

When connecting coils, refer to the wiring diagram to prevent mis-operation or malfunction.

**3. Cleaning**

This relay is not sealed, therefore, immersion may cause failure. Be careful that flux does not overflow onto the PC board or penetrate inside the relay.

**4. Soldering**

When using automatic soldering, the following conditions are recommended

- 1) Preheating: 120°C 248°F, within 120 Sec (PC board solder surface)
- 2) Soldering: 260°C±5°C 500°F±41°F, within 6 Sec

**5. Installation**

1) Attach directly to the chassis or use a DIN rail.

(1) When attaching directly to chassis

- Use a M3.5 screw, spring washer, and hex nut.

- For the mounting pitch, refer to the dimensions.

(2) When installing on a DIN rail

- Use a 35 mm 1.378 inch wide DIN rail (DIN46277).
- Install and remove as shown in the figures below.

<When installing>

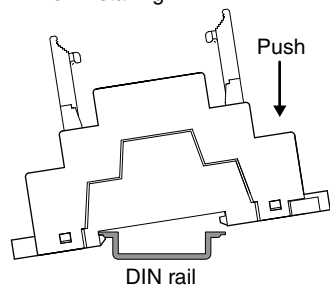

<When removing>

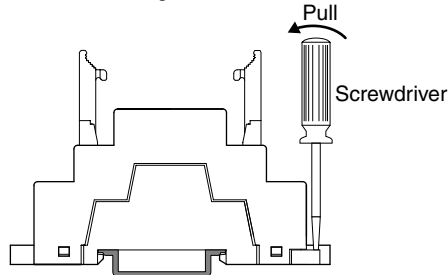

2) Refer to the figure below for applicable wire-pressed terminals.

(You cannot use round type wire-pressed terminals.)

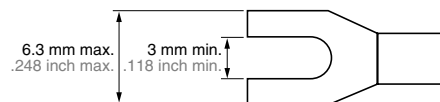
**6. Other**

1) If the relay has been dropped, the appearance and characteristics should always be checked before use.

2) The switching lifetime is defined under the standard test condition specified in the JIS\* C 5442-1996 standard (temperature 15 to 35°C 59 to 95°F, humidity 25 to 75%). Check this with the actual product as it is affected by the coil driving circuit, load type, activation frequency, activation phase, ambient conditions and other factors.

Also, be especially careful with loads such as those listed below.

(1) When used for AC load-operation and the operating phase is synchronous.

Rocking and fusing can easily occur due to contact shifting.

(2) During high frequency on/off operation with certain loads, arcing may occur at the contacts. This can cause fusion to Oxygen and Nitrogen gas in the air creating Nitric Acid (HNO<sub>3</sub>) which can cause corrosion to the contacts. Please see the following countermeasure examples:

1. Incorporate an arc-extinguishing circuit.
2. Lower the operating frequency
3. Lower the ambient humidity

3) For secure operations, nominal coil voltage should be applied. In addition, please note that pick-up and drop-out voltage will vary according to the ambient temperature and operating conditions.

4) Heat, smoke, and/or fire may occur if the relay is used outside the allowable ranges for the coil ratings, contact ratings, operating cycle lifetime, and other specifications. Therefore, do not use the relay if these ratings are exceeded. Also, make sure that the relay is wired correctly.

5) Incorrect wiring may cause false operation or generate heat or flames.  
6) Check the ambient conditions when storing or transporting the relays and devices containing the relays. Freezing or condensation may occur in the relay causing damage. Avoid exposing the relays to heavy loads, or strong shock and vibration.

**7. Usage, transport and storage conditions**

1) Ambient temperature, humidity, and atmospheric pressure during usage, transport, and storage of the relay:

(1) Temperature:

−40 to +85°C −40 to +185°F

(When the temperature is 70 to 80°C, reduce the 6 A max. switching current by 0.1 A/°C.)

(2) Humidity: 5 to 85% RH

(Avoid freezing and condensation.)

The humidity range varies with the temperature. Use within the range indicated in the graph below.

(3) Atmospheric pressure: 86 to 106 kPa

Temperature and humidity range for usage, transport, and storage

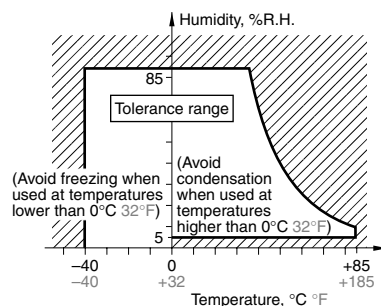

2) Condensation

Condensation forms when there is a sudden change in temperature under high temperature and high humidity conditions. Condensation will cause deterioration of the relay insulation.

3) Freezing

Condensation or other moisture may freeze on the relay when the temperatures is lower than 0°C 32°F. This causes problems such as sticking of movable parts or operational time lags.

4) Low temperature and low humidity

At low temperature, low humidity environments, the plastic becomes brittle. Please note corrections.

**For Cautions for Use, see Relay Technical Information.**