

Gallium Nitride 48V, 100W, DC-2.2 GHz HEMT

Built using the SIGANTIC[®] process - A proprietary GaN-on-Silicon technology

Features

- Suitable for linear and saturated applications
- Tunable from DC-2.2 GHz
- 48V Operation
- Industry Standard Package
- High Drain Efficiency (>60%)



Applications

- Defense Communications
- Land Mobile Radio
- Avionics
- Wireless Infrastructure
- ISM Applications
- VHF/UHF/L-Band Radar

DC-2.2 GHz
100W
GaN HEMT



Product Description

The NPT2010 GaN HEMT is a wideband transistor optimized for DC-2.2 GHz operation. This device has been designed for CW, pulsed, and linear operation with output power levels to 100W (50 dBm) in an industry standard metal-ceramic package with a bolt down flange.

RF Specifications (CW, 2.15 GHz): $V_{DS} = 48V$, $I_{DQ} = 600mA$, $T_C = 25^\circ C$

Symbol	Parameter	Min	Typ	Max	Units
G_{SS}	Small-signal Gain	-	17	-	dB
P_{SAT}	Saturated Output Power	-	50.5	-	dBm
η_{SAT}	Efficiency at Saturated Output Power	-	64	-	%
G_P	Gain at $P_{OUT} = 95W$	13.5	15	-	dB
η	Drain Efficiency at $P_{OUT} = 95W$	52.5	61	-	%
V_{DS}	Drain Voltage	-	48	-	V
Ψ	Ruggedness: Output Mismatch, all phase angles	VSWR = 10:1, No Device Damage			

DC Specifications: $T_C = 25^\circ\text{C}$

Symbol	Parameter	Min	Typ	Max	Units
Off Characteristics					
I_{DLK}	Drain-Source Leakage Current ($V_{GS}=-8\text{V}$, $V_{DS}=160\text{V}$)	-	-	24	mA
I_{GLK}	Gate-Source Leakage Current ($V_{GS}=-8\text{V}$, $V_{DS}=0\text{V}$)	-	-	12	mA
On Characteristics					
V_T	Gate Threshold Voltage ($V_{DS}=48\text{V}$, $I_D=24\text{mA}$)	-2.5	-1.5	-0.5	V
V_{GSQ}	Gate Quiescent Voltage ($V_{DS}=48\text{V}$, $I_D=600\text{mA}$)	-2.1	-1.2	-0.3	V
R_{ON}	On Resistance ($V_{DS}=2\text{V}$, $I_D=180\text{mA}$)	-	0.2	-	Ω
$I_{D, MAX}$	Maximum Drain Current ($V_{DS}=7\text{V}$ pulsed, 300 μs pulse width, 0.2% Duty Cycle)	-	14	-	A

Thermal Resistance Specification:

Symbol	Parameter	Typ	Units
$R_{\theta JC}$	Thermal Resistance (Junction-to-Case), $T_J = 200^\circ\text{C}$	1.75	$^\circ\text{C}/\text{W}$

Junction Temperature (T_J) measured using IR Microscopy, Case Temperature (T_C) measured using a thermocouple embedded in heatsink.

Absolute Maximum Ratings: Not simultaneous, $T_C = 25^\circ\text{C}$ unless otherwise noted

Symbol	Parameter	Max	Units
V_{DS}	Drain-Source Voltage	160	V
V_{GS}	Gate-Source Voltage	-10 to 3	V
I_G	Gate Current	48	mA
P_T	Total Device Power Dissipation (Derated above 25°C)	114	W
T_{STG}	Storage Temperature Range	-65 to 150	$^\circ\text{C}$
T_J	Operating Junction Temperature	225	$^\circ\text{C}$
HBM	Human Body Model ESD Rating (per JESD22-A114)	Class 1A	

Load-Pull Data, Reference Plane at Device Leads

$V_{DS}=48V$, $I_{DQ}=600mA$, $T_C=25^\circ C$ unless otherwise noted

Optimum Source and Load Impedances:

(CW Drain Efficiency and Output Power Tradeoff Impedance)

Frequency (MHz)	$Z_S (\Omega)$	$Z_L (\Omega)$	$P_{SAT} (W)$	$G_{SS} (dB)$	Drain Efficiency @ P_{SAT} (%)
500	$1.1 + j0.8$	$5.9 + j2.0$	144	26.1	66.8
900	$1.3 - j1.7$	$5.7 + j3.2$	125	21.9	71.4
2200	$2.0 - j6.5$	$2.7 - j1.9$	115	16.6	66.6

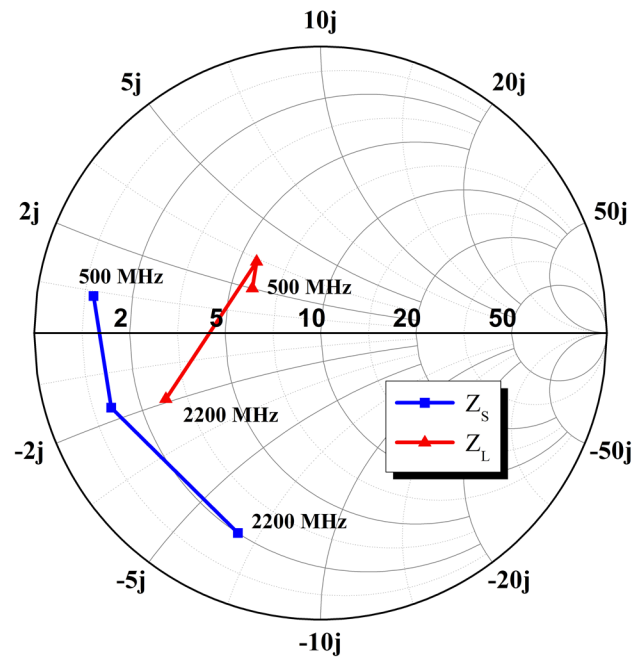
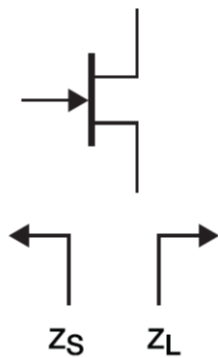

Figure 1: CW Power/Drain Efficiency Tradeoff Impedances, $Z_0=10\Omega$

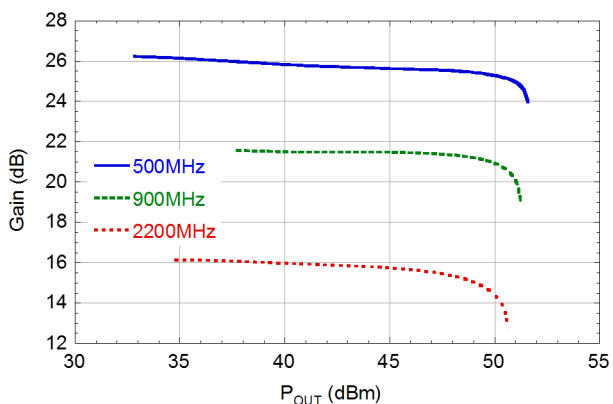

Figure 2: Gain vs. P_{OUT}

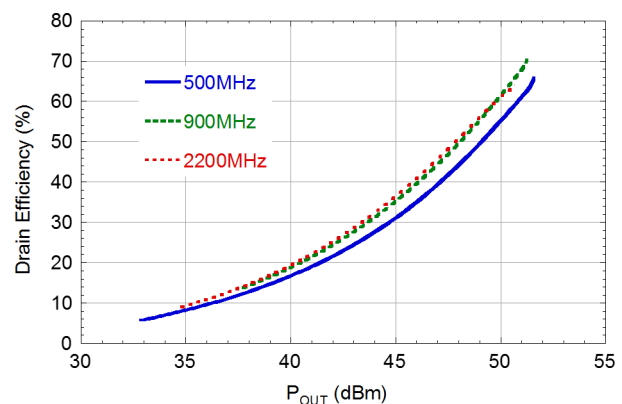

Figure 3: Efficiency vs. P_{OUT}

2.15 GHz Narrowband Circuit

(CW, $V_{DS}=48V$, $I_{DQ}=600mA$, $T_C=25^\circ C$, unless otherwise noted)

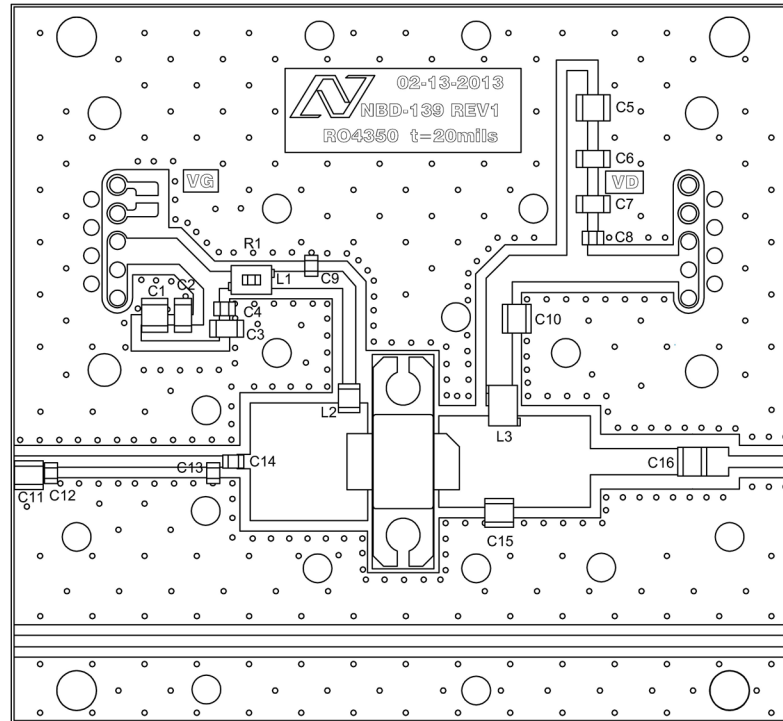

Figure 4: Component Placement of 2.15 GHz Narrowband Circuit for NPT2010

Reference	Value	Manufacturer	Part Number
C1, C5	1uF	AVX	1210C105KAT2A
C2, C6	0.1uF	Kemet	C1206C104K1RACTU
C3, C7	0.01uF	AVX	1206C103KAT2A
C4, C8	1000pF	Kemet	C0805C102K1RACTU
C9	240pF	ATC	ATC600F241B
C10	10pF	ATC	ATC800B100B
C11	1pF	ATC	ATC800B1R0B
C12	0.8pF	ATC	ATC600F0R8B
C13	0.9pF	ATC	ATC600F0R9B
C14	10pF	ATC	ATC600F100B
C15	1.5pF	ATC	ATC800B1R5B
C16	15pF	ATC	ATC800B150B
L1	12.5nH	CoilCraft	A04TJL
L2	19.4nH	CoilCraft	0806SQ-19NJL
L3	8.0nH	CoilCraft	A03TJL
R1	15Ω	Panasonic	ERJ-2RKF15R0X
PCB	RO4350, $\epsilon_r=3.5$, 0.020"	Rogers	Nitronex NBD-139r1

Typical Performance in 2.15 GHz Narrowband Circuit

(CW, $V_{DS}=48V$, $I_{DQ}=600mA$, $f=2.15GHz$, $T_C=25^\circ C$, unless otherwise noted)

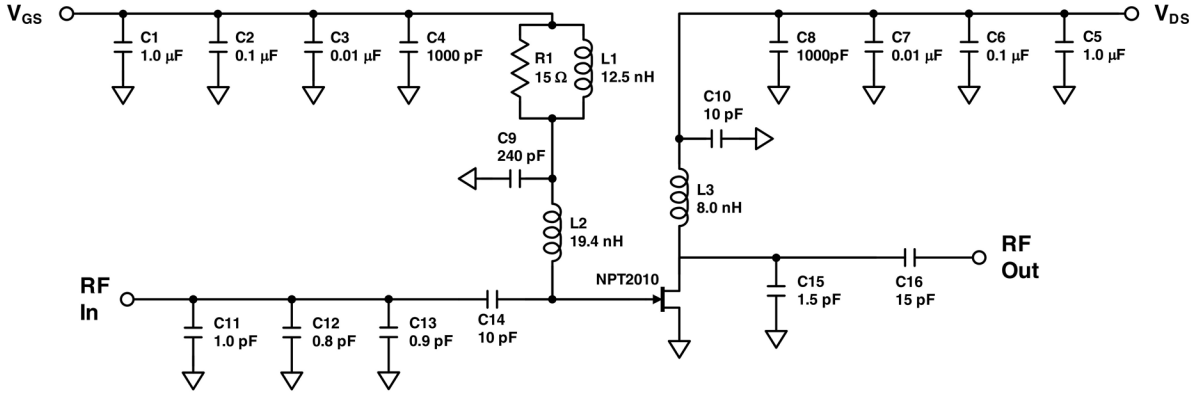

Figure 5. Electrical Schematic of 2.15 GHz Narrowband Circuit for NPT2010
(For RF Tuning details see Component Placement Diagram Figure 4)

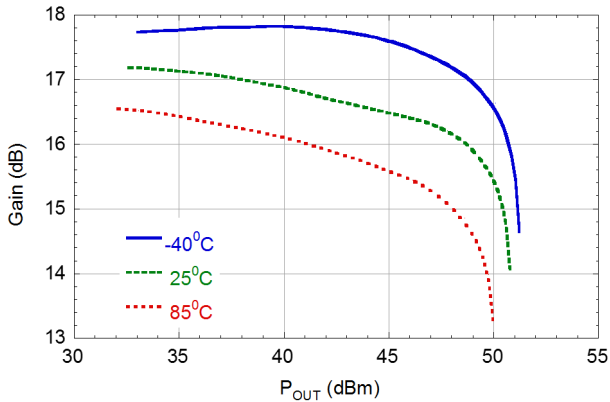

Figure 6: Gain vs. P_{OUT}

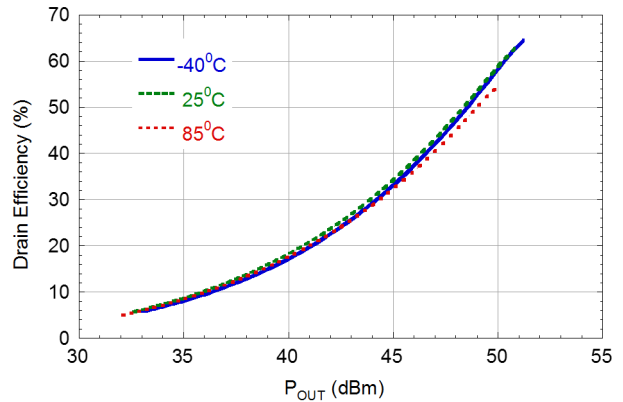

Figure 7: Drain Efficiency vs. P_{OUT}

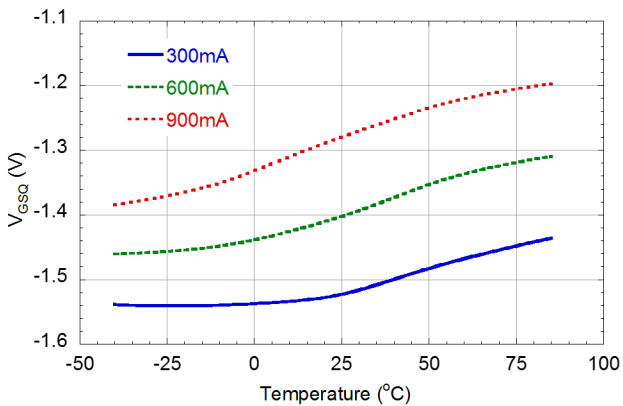

Figure 8: Quiescent V_{GS} vs. Temperature

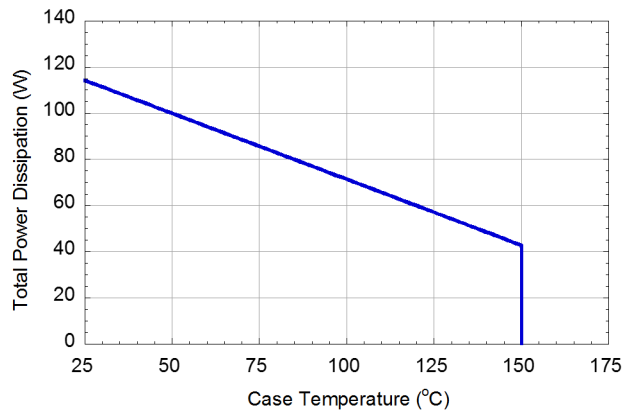

Figure 9: Power De-rating Curve
($T_J = 225^\circ C$, $T_C > 25^\circ C$)

Typical Performance in 2.15 GHz Narrowband Circuit

(CW, $V_{DS}=48V$, $I_{DQ}=600mA$, $f=2.15GHz$, $T_C=25^\circ C$, unless otherwise noted)

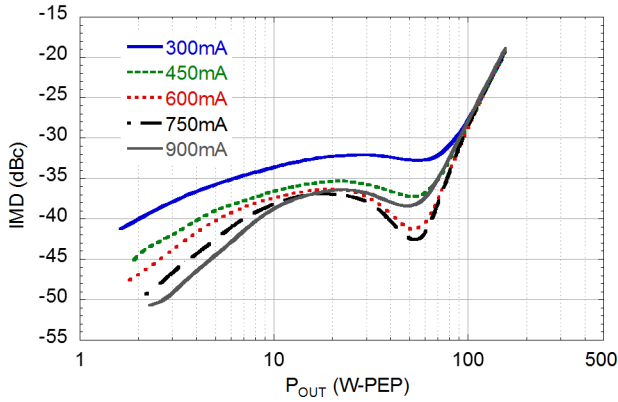

Figure 10: 2-Tone IMD3 vs. P_{OUT} vs. I_{DQ}
(1MHz Tone Spacing)

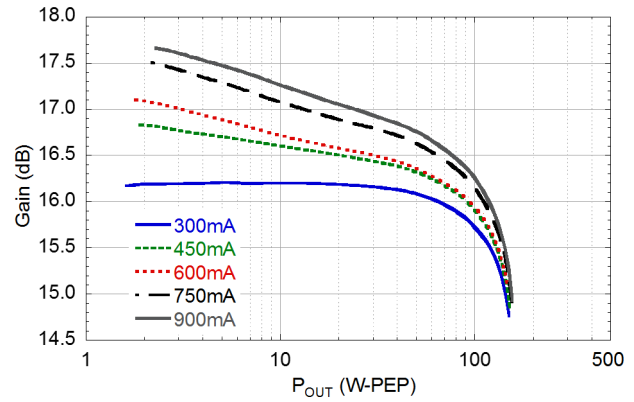

Figure 11: 2-Tone Gain vs. P_{OUT} vs. I_{DQ}
(1MHz Tone Spacing)

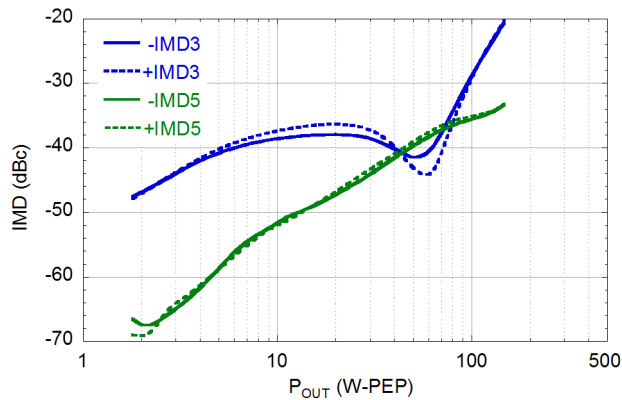

Figure 12: 2-Tone IMD vs. P_{OUT}
(1MHz Tone Spacing)

100-700 MHz Broadband Circuit

(CW, $V_{DS}=48V$, $I_{DQ}=600mA$, $T_C=25^\circ C$, unless otherwise noted)

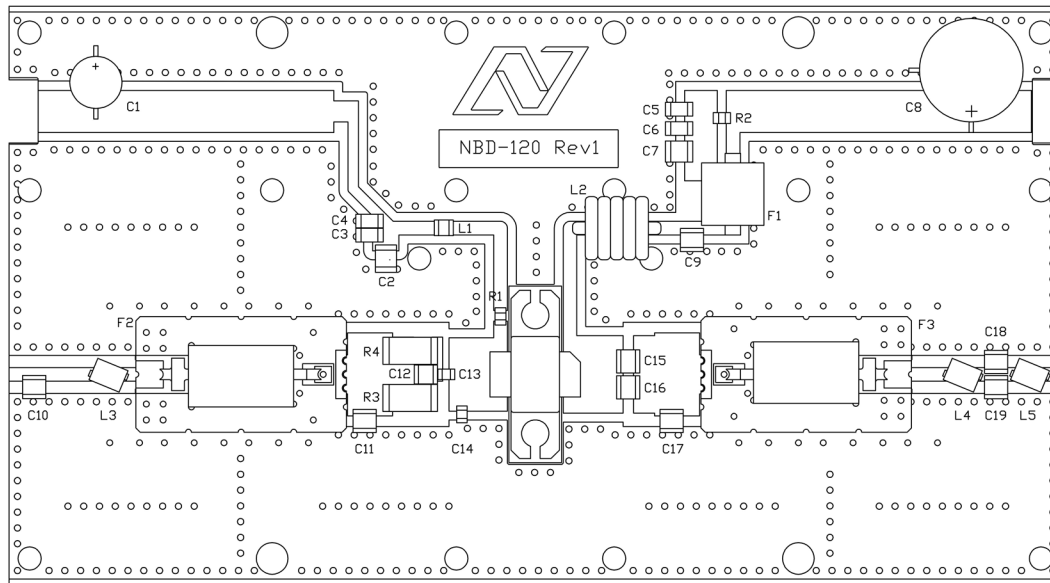

Figure 13: Component Placement of 100-700 MHz Broadband Circuit for NPT2010

Reference	Value	Manufacturer	Part Number
C1	150uF	Nichicon	UPW1C151MED
C2, C7	1uF	AVX	1210C105KAT2A
C3, C6	0.1uF	Kemet	C1206C104K1RACTU
C4, C5	0.01uF	AVX	12061C103KAT2A
C8	270uF	United Chemi-Con	ELXY 630ELL271MK25S
C9	18pF	ATC	ATC100B180
C10, C19	2.4pF	ATC	ATC100B2R4
C11	5.6pF	ATC	ATC100B5R6
C12	15pF	ATC	ATC100B150
C13	220pF	ATC	600F221FT
C14	12pF	ATC	600F120FT
C15, C16	82pF	ATC	ATC100B820
C17	4.7pF	ATC	ATC100B4R7
C18	2pF	ATC	ATC100B2R0
R1	49.9Ω	Panasonic	ERJ-6ENF49R9V
R2	0.33Ω	Panasonic	ERJ-6RQFR33V
R3, R4	24.9Ω	Panasonic	ERJ-1TNF24R9U
F1	Material 73	Fair-Rite	2673000801
F2, F3	4:1 Transformer	Anaren	XMT031B5012
L1	1.8μH	Coilcraft	0805LS-182XJLC
L2	~50nH	16 AWG Cu Wire	5 turn, 0.2"ID
L3	5nH	Coilcraft	A02TJL
L4, L5	8nH	Coilcraft	A03TJL
PCB	RO4350, er=3.5, 0.020"	Rogers	Nitronex NBD-120r1

Typical Performance in 100-700 MHz Broadband Circuit

(CW, $V_{DS}=48V$, $I_{DQ}=600mA$, $T_C=25^\circ C$, unless otherwise noted)

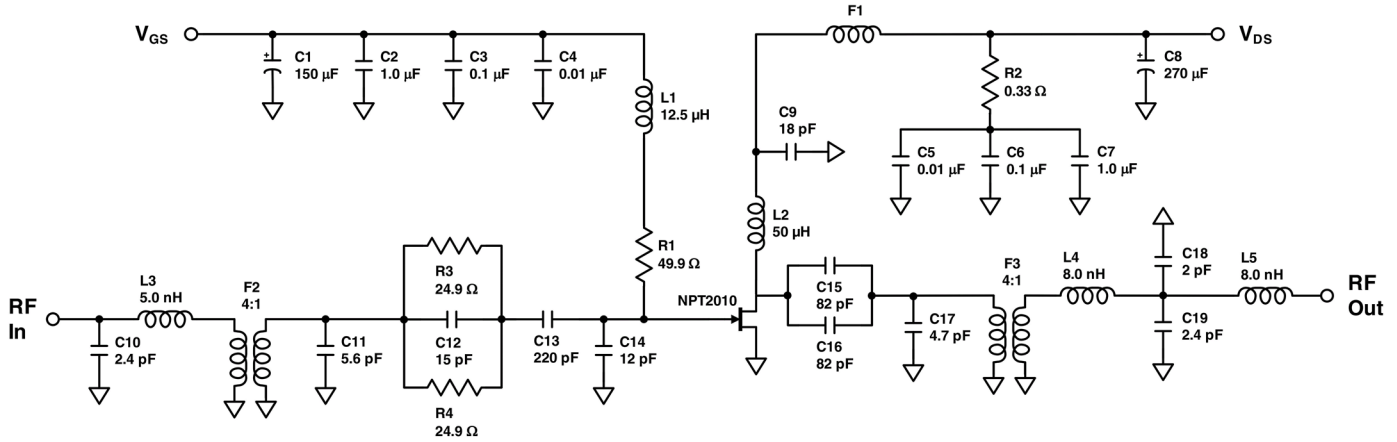

Figure 14. Electrical Schematic of 100-700 MHz Broadband Circuit for NPT2010
(For RF Tuning details see Component Placement Diagram Figure 13)

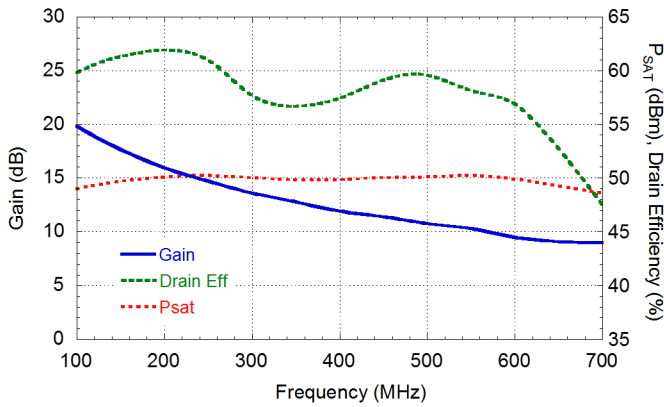

Figure 15: Performance vs. Frequency
($P_{OUT} = P_{SAT}$)

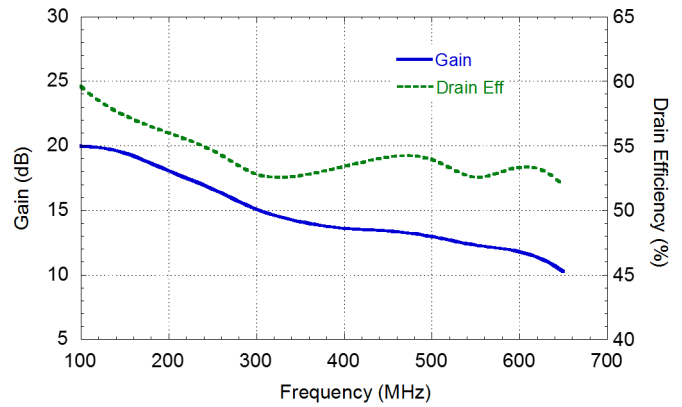

Figure 16: Performance vs. Frequency
($P_{OUT} = 49dBm$)

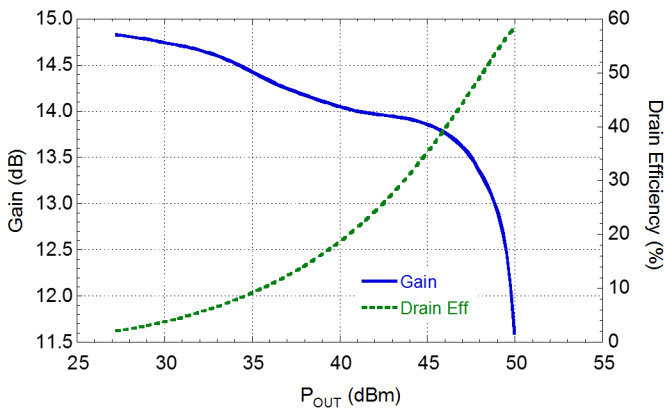

Figure 17: Gain/Drain Efficiency vs. P_{OUT}
($f = 500MHz$)

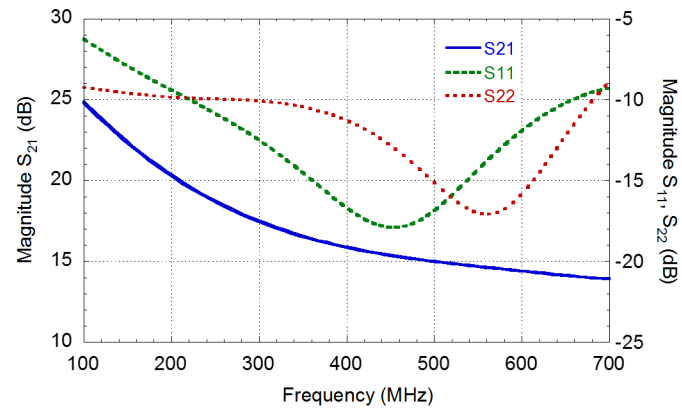

Figure 18: Small Signal s-parameters vs. Frequency

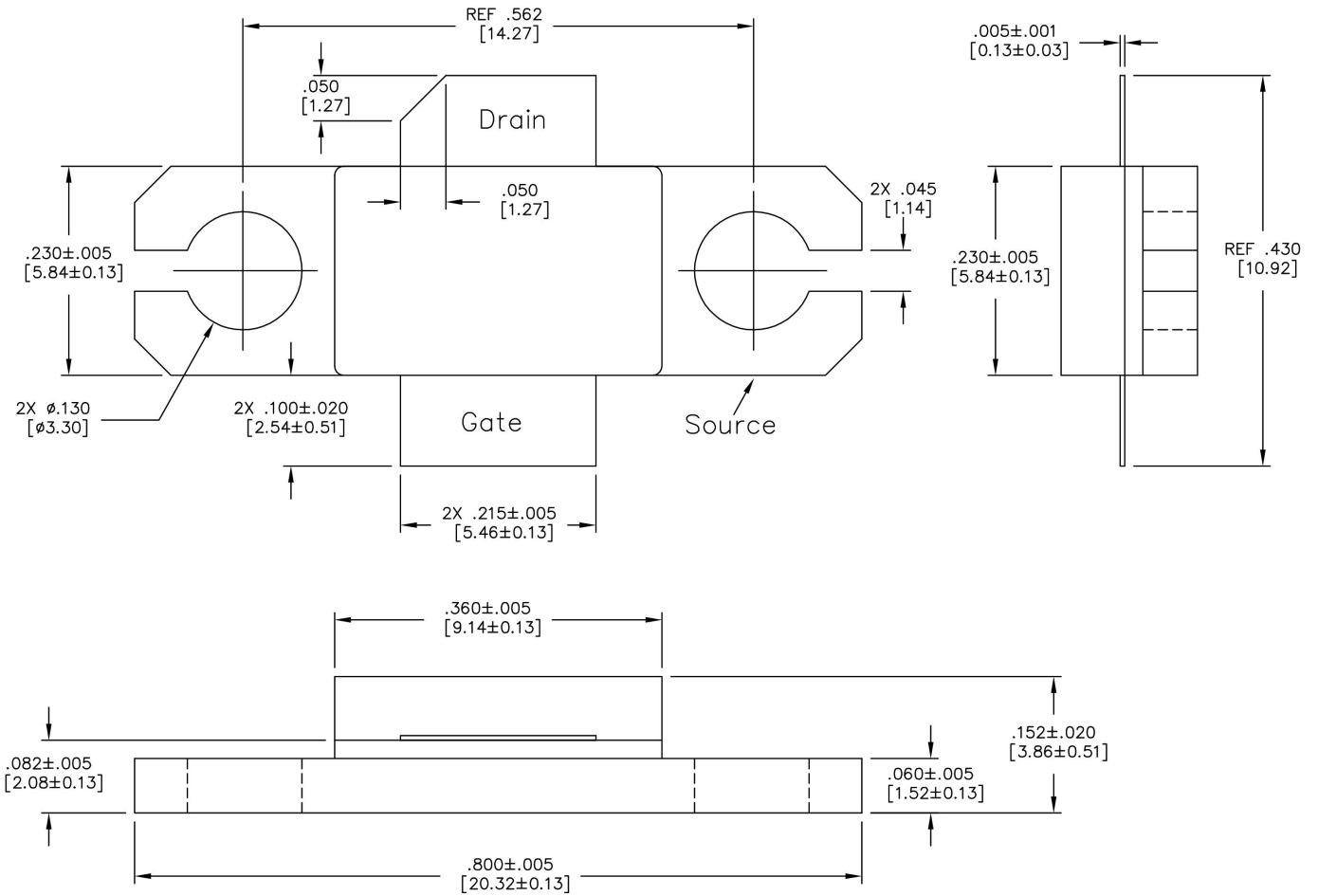

Figure 19 - AC360B-2 Metal-Ceramic Package Dimensions (all dimensions in inches [millimeters])

Function
Gate — RF Input
Drain — RF Output (Cut lead)
Source — Ground (Flange)

Nitronex, LLC

2305 Presidential Drive
Durham, NC 27703 USA
+1.919.807.9100 (telephone)
+1.919.807.9200 (fax)
info@nitronex.com
www.nitronex.com

Additional Information

**This part is lead-free and is compliant with the RoHS directive
(Restrictions on the Use of Certain Hazardous Substances in Electrical and Electronic Equipment).**

Important Notice

Nitronex, LLC reserves the right to make corrections, modifications, enhancements, improvements and other changes to its products and services at any time and to discontinue any product or service without notice. Customers should obtain the latest relevant information before placing orders and should verify that such information is current and complete. All products are sold subject to Nitronex terms and conditions of sale supplied at the time of order acknowledgment. The latest information from Nitronex can be found either by calling Nitronex at 1-919-807-9100 or visiting our website at www.nitronex.com.

Nitronex warrants performance of its packaged semiconductor or die to the specifications applicable at the time of sale in accordance with Nitronex standard warranty. Testing and other quality control techniques are used to the extent Nitronex deems necessary to support the warranty. Except where mandated by government requirements, testing of all parameters of each product is not necessarily performed.

Nitronex assumes no liability for applications assistance or customer product design. Customers are responsible for their product and applications using Nitronex semiconductor products or services. To minimize the risks associated with customer products and applications, customers should provide adequate design and operating safeguards.

Nitronex does not warrant or represent that any license, either express or implied, is granted under any Nitronex patent right, copyright, mask work right, or other Nitronex intellectual property right relating to any combination, machine or process in which Nitronex products or services are used.

Reproduction of information in Nitronex data sheets is permitted if and only if said reproduction does not alter any of the information and is accompanied by all associated warranties, conditions, limitations and notices. Any alteration of the contained information invalidates all warranties and Nitronex is not responsible or liable for any such statements.

Nitronex products are not intended or authorized for use in life support systems, including but not limited to surgical implants into the body or any other application intended to support or sustain life. Should Buyer purchase or use Nitronex, LLC products for any such unintended or unauthorized application, Buyer shall indemnify and hold Nitronex, LLC, its officers, employees, subsidiaries, affiliates, distributors, and its successors harmless against all claims, costs, damages, and expenses, and reasonable attorney fees arising out of, directly or indirectly, any claim of personal injury or death associated with such unintended or unauthorized use, notwithstanding if such claim alleges that Nitronex was negligent regarding the design or manufacture of said products.

Nitronex and the Nitronex logo are registered trademarks of Nitronex, LLC.

All other product or service names are the property of their respective owners.

©Nitronex, LLC 2013 All rights reserved.