

LEA50F



Features

- Harmonic attenuator, PFC (Complies with IEC61000-3-2)
- Universal input (AC85-264V)
- Remote ON/OFF Control (Optional)
- Rugged PCB type
- RoHS Compliant

Safety Agency Approvals

- Complies with DEN-AN
- UL1950, C-UL recognized, TUV approved

EMI Compliance

- FCC-B
- CISPR22-B
- EN55022-B
- VCCI-B

CE Markings

- Low Voltage Directive
- EMC Directive

EMC Compliance

- EN61000-4-2
- EN61000-4-3
- EN61000-4-4
- EN61000-4-5
- EN61000-4-6
- EN61000-4-8
- EN61000-4-11
- EN61000-3-2

2 year warranty(refer to Instruction Manual)

Model	Input Voltage [V]	Output Wattage [W]	DC Output [V/A]
LEA50F-3R3-Y	DC 120 - 370 AC 85 - 264	33	3.3V 10A
LEA50F-5	DC 120 - 370 AC 85 - 264	50	5V 10A
LEA50F-9	DC 120 - 370 AC 85 - 264	50.4	9V 5.6A
LEA50F-12	DC 120 - 370 AC 85 - 264	51.6	12V 4.3A
LEA50F-15	DC 120 - 370 AC 85 - 264	52.5	15V 3.5A
LEA50F-18	DC 120 - 370 AC 85 - 264	50.4	18V 2.8A
LEA50F-24	DC 120 - 370 AC 85 - 264	50.4	24V 2.1A
LEA50F-24-H	DC 120 - 370 AC 85 - 264	50.4	24V (peak 62.4V) 2.1A (peak 2.6A)
LEA50F-30	DC 120 - 370 AC 85 - 264	51	30V 1.7A
LEA50F-48	DC 120 - 370 AC 85 - 264	52.8	48V 1.1A

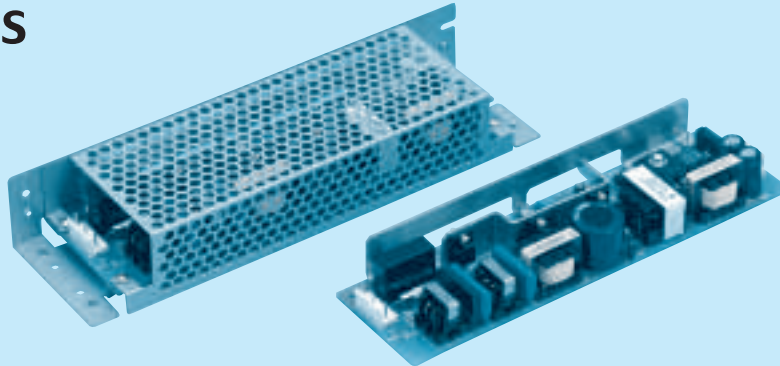

Recommended Noise Filter
NAC-06-472



High voltage pulse noise type : NAP series
Low leakage current type : NAM series
* The Noise Filter is recommended to connect with several devices.

- ① Series name
- ② Output wattage
- ③ Universal input
- ④ Output voltage
- ⑤ Optional
- C : with Coating
- G : Low leakage current
- J2: Mini terminal block
- R : with Remote ON/OFF
- S : with Chassis
- SN: with Chassis & cover
- Y : with Potentiometer

MODEL	LEA50F-3R3-Y	LEA50F-5	LEA50F-9	LEA50F-12	LEA50F-15	LEA50F-18	LEA50F-24	LEA50F-24-H	LEA50F-30	LEA50F-48
MAX OUTPUT WATTAGE[W]	33	50	50.4	51.6	52.5	50.4	50.4	50.4	51	52.8
DC OUTPUT	*5 3.3V 10A	5V 10A	9V 5.6A	12V 4.3A	15V 3.5A	18V 2.8A	24V 2.1A	24V 2.1(2.6)A	30V 1.7A	48V 1.1A

SPECIFICATIONS

	MODEL	LEA50F-3R3-Y	LEA50F-5	LEA50F-9	LEA50F-12	LEA50F-15	LEA50F-18	LEA50F-24	LEA50F-24-H	LEA50F-30	LEA50F-48	
INPUT	VOLTAGE[V]	AC85 - 264 1φ or DC120 - 370										
	CURRENT[A]	ACIN 100V	0.6	0.7typ								
		ACIN 200V	0.3	0.35typ								
	FREQUENCY[Hz]	50/60 (47 - 63) or DC										
	EFFICIENCY[%]	ACIN 100V	70typ	75typ	78typ	78typ	79typ	80typ	81typ	81typ	82typ	83typ
		ACIN 200V	71typ	77typ	80typ	80typ	81typ	82typ	83typ	83typ	84typ	85typ
	POWER FACTOR	ACIN 100V	0.98typ	0.99typ								
		ACIN 200V	0.91typ	0.93typ								
INRUSH CURRENT[A]	ACIN 100V	15typ (Io=100%) (At cold start) (Ta=25°C)										
	ACIN 200V	30typ (Io=100%) (At cold start) (Ta=25°C)										
LEAKAGE CURRENT[mA]	0.75max (60Hz, According to IEC60950 and DEN-AN)											
OUTPUT	VOLTAGE[V]	3.3	5	9	12	15	18	24	24	30	48	
	CURRENT[A]	*1 10	10	5.6	4.3	3.5	2.8	2.1	2.1 (Peak 2.6)	1.7	1.1	
	LINE REGULATION[mV]	20max	20max	36max	48max	60max	72max	96max	96max	120max	192max	
	LOAD REGULATION[mV]	40max	40max	100max	100max	120max	120max	150max	150max	180max	300max	
	RIPPLE[mVp-p]	0 to +50°C *2	80max	80max	120max	120max	120max	120max	150max	150max	180max	300max
		-10 - 0°C *2	140max	140max	160max	160max	160max	160max	160max	160max	160max	200max
	RIPPLE NOISE[mVp-p]	0 to +50°C *2	120max	120max	150max	150max	150max	150max	150max	150max	150max	350max
		-10 - 0°C *2	160max	160max	180max	180max	180max	180max	180max	180max	180max	400max
	TEMPERATURE REGULATION[mV]	0 to +50°C	50max	50max	90max	120max	150max	180max	240max	240max	300max	480max
		-10 to +50°C	60max	60max	120max	150max	180max	200max	290max	290max	360max	600max
	DRIFT[mV]	*3 20max	20max	36max	48max	60max	72max	96max	96max	120max	192max	
	START-UP TIME[ms]	500max (ACIN 100V, Io=100%)										
	HOLD-UP TIME[ms]	20typ (Io=100%)										
	OUTPUT VOLTAGE ADJUSTMENT RANGE[V]	2.85 - 3.6	Fixed (*Y which can be adjusted the output is available as optional: ±10%)									
OUTPUT VOLTAGE SETTING[V]	3.25 - 3.35	4.9 - 5.3	8.6 - 9.4	11.5 - 12.5	14.4 - 15.6	17.3 - 18.7	23.0 - 25.0	23.0 - 25.0	28.5 - 31.5	46.0 - 50.0		
PROTECTION CIRCUIT AND OTHERS	OVERCURRENT PROTECTION	Works over 105% of rating (works over 105% of peak current at option -H) and recovers automatically										
	OVERVOLTAGE PROTECTION	4.00 - 5.25V Works at 115 - 140% of rating										
	OPERATING INDICATION	Not provided										
	REMOTE SENSING	Not provided										
REMOTE ON/OFF	Option (Refer to Instruction Manual)											
ISOLATION	INPUT-OUTPUT · RC	*4 AC3.000V 1minute, Cutoff current = 10mA, DC500V 50MΩ min (At Room Temperature)										
	INPUT-FG	AC2.000V 1minute, Cutoff current = 10mA, DC500V 50MΩ min (At Room Temperature)										
	OUTPUT · RC-FG	*4 AC500V 1minute, Cutoff current = 100mA, DC500V 50MΩ min (At Room Temperature)										
	OUTPUT-RC	*4 AC100V 1minute, Cutoff current = 100mA, DC100V 10MΩ min (At Room Temperature)										
ENVIRONMENT	OPERATING TEMP., HUMID. AND ALTITUDE	-10 to +70°C, 20 - 90%RH (Non condensing) (Refer to DERATING CURVE), 3,000m (10,000feet) max										
	STORAGE TEMP., HUMID. AND ALTITUDE	-20 to +75°C, 20 - 90%RH (Non condensing), 9,000m (30,000feet) max										
	VIBRATION	10 - 55Hz, 19.6m/s ² (2G), 3minutes period, 60minutes each along X, Y and Z axis										
	IMPACT	196.1m/s ² (20G), 11ms, once each X, Y and Z axis										
SAFETY AND NOISE REGULATIONS	AGENCY APPROVALS	UL60950-1, C-UL, EN60950-1, EN50178 Complies with DEN-AN and IEC60950-1 (At only AC input)										
	CONDUCTED NOISE	Complies with FCC-B, CISPR22-B, EN55022-B, VCCI-B										
	HARMONIC ATTENUATOR	Complies with IEC61000-3-2										
OTHERS	CASE SIZE/WEIGHT	55 x 26 x 195mm (W x H x D) / 210g max (without chassis and cover)										
	COOLING METHOD	Convection										

*1 Peak load for 10sec. or less is acceptable if the total wattage is less than the rated wattage.
 *2 This is the value that measured on measuring board with capacitor of 22 μF within 150mm from output terminal.
 Measured by 20MHz oscilloscope or Ripple-Noise meter (Equivalent to KEISOKU-GIKEN: RM101).
 *3 Drift is the change in DC output for an eight hour period after a half-hour warm-up at 25°C,

with the input voltage held constant at the rated input/output.
 *4 Applicable when remote control (optional) is added.
 *5 (): peak current.
 * Parallel operation with other model is not possible.
 * Derating is required when operated with chassis and cover.

External view

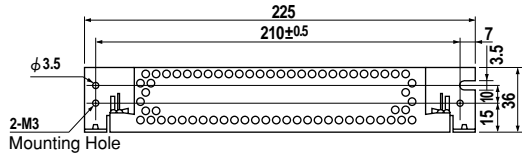
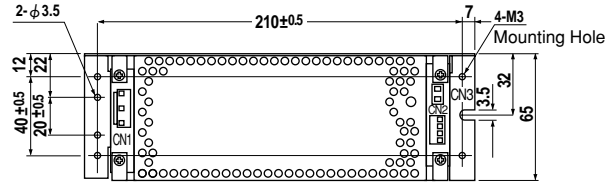
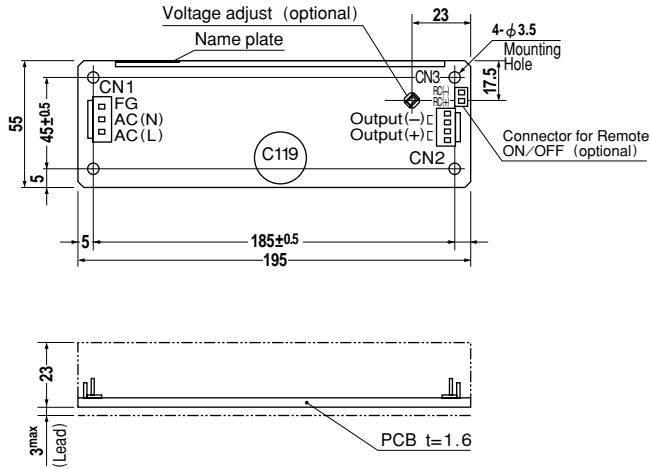

I / O Connector	Mating Connector	Terminal	
CN1	B3P5-VH	VHR-5N	Chain: SVH-21T-P1.1
			Loose: BVH-21T-P1.1
CN2	B4P-VH	VHR-4N	Chain: SVH-21T-P1.1
			Loose: BVH-21T-P1.1
CN3	B2B-XH-A	XHP-2	Chain: SXH-001T-P0.6
			Loose: BXH-001T-P0.6

Pin No.	Input
1	AC(L)
2	
3	AC(N)
4	
5	FG

Pin No.	Output
1	-V
2	-V
3	+V
4	+V

Pin No.	Remote ON/OFF
1	RC(+)
2	RC(-)

※Weight: 210g or less (Without chassis and cover)
 ※Tolerance: ±1
 ※Dimensions in mm.
 ※PCB Material: Glass composite (CEM3)
 ※Chassis and cover is optional.
 ※Mounting torque: 0.6N·m(6.3kgf·cm)max

(Mfr: J.S.T.) ※Keep drawing current per pin below 5A for CN2

LEA

Performance data

RISE TIME & FALL TIME (LEA50F-5)

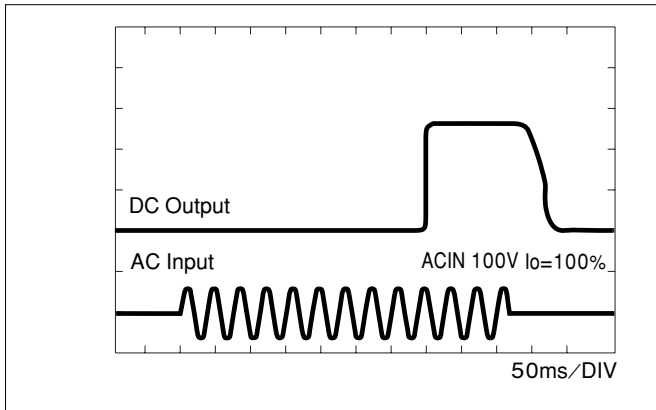

EFFICIENCY (LEA50F-5)

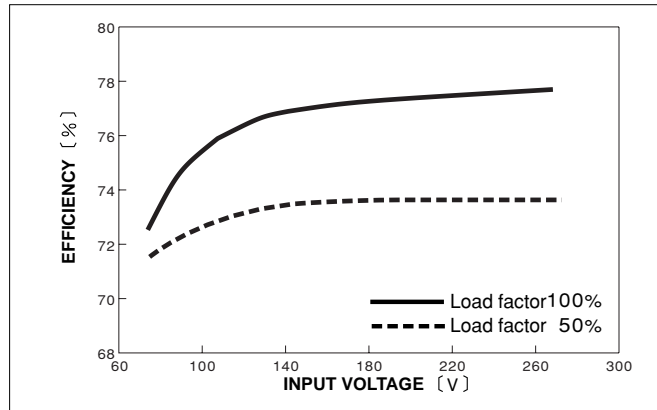

INPUT HARMONIC CURRENT (LEA50F-5)

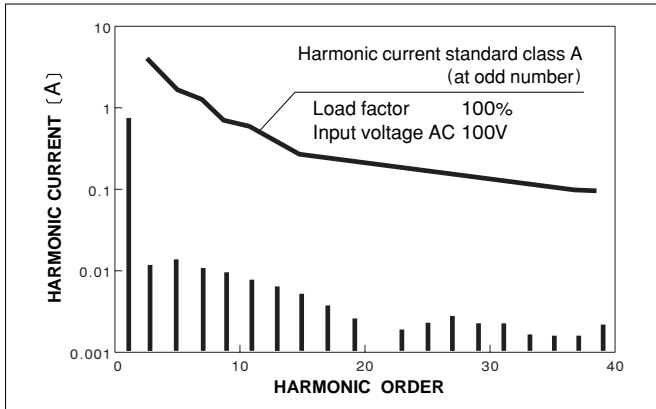

INPUT HARMONIC CURRENT (LEA50F-5)

