

STANDARD TRIAC

TO-220AB

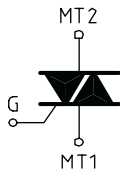
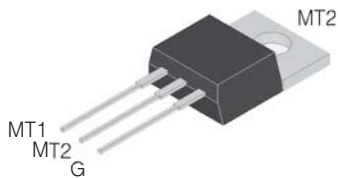

On-State Current

25 Amp

Gate Trigger Current

≤ 100 mA

Off-State Voltage

200 V ÷ 800 V

This series of TRIACs uses a high performance PNPN technology.

These parts are intended for general purpose AC switching applications with highly inductive loads.

Absolute Maximum Ratings, according to IEC publication No. 134

SYMBOL	PARAMETER	CONDITIONS	Value	Unit
$I_{T(RMS)}$	RMS On-state Current (full sine wave)	All Conduction Angle, $T_c = 100\text{ }^\circ\text{C}$	25	A
I_{TSM}	Non-repetitive On-State Current	Full Cycle, 60 Hz ($t = 16.7\text{ ms}$)	275	A
I_{TSM}	Non-repetitive On-State Current	Full Cycle, 50 Hz ($t = 20\text{ ms}$)	250	A
I^2t	Fusing Current	$t_p = 10\text{ ms}$, Half Cycle	313	A ² s
I_{GM}	Peak Gate Current	20 μs max. $T_j = 125\text{ }^\circ\text{C}$	4	A
$P_{G(AV)}$	Average Gate Power Dissipation	$T_j = 125\text{ }^\circ\text{C}$	1	W
di / dt	Critical rate of rise of on-state current	$I_G = 2x I_{GT}$, $t_r \leq 100\text{ ns}$ $f = 120\text{ Hz}$, $T_j = 125\text{ }^\circ\text{C}$	50	A/ μs
T_j	Operating Temperature		(-40 +125)	$^\circ\text{C}$
T_{stg}	Storage Temperature		(-40 +150)	$^\circ\text{C}$
T_{sld}	Soldering Temperature	10s max	260	$^\circ\text{C}$

SYMBOL	PARAMETER	VOLTAGE					Unit
		B	D	M	S	N	
V_{DRM} V_{RRM}	Repetitive Peak Off State Voltage	200	400	600	700	800	V

STANDARD TRIAC
Electrical Characteristics

SYMBOL	PARAMETER	CONDITIONS	Quadrant		SENSITIVITY				Unit
					10	13	18	17	
$I_{GT}^{(1)}$	Gate Trigger Current	$V_D = 12 V_{DC}, R_L = 33\Omega, T_j = 25^\circ C$	Q1÷Q3	MAX	25	50	25	50	mA
			Q4	MAX	25	75	50	100	mA
V_{GT}	Gate Trigger Voltage	$V_D = 12 V_{DC}, R_L = 33\Omega, T_j = 25^\circ C$	Q1÷Q4	MAX	1.3				V
V_{GD}	Gate Non Trigger Voltage	$V_D = V_{DRM}, R_L = 3.3 K\Omega, T_j = 125^\circ C$	Q1÷Q4	MIN	0.2				V
$I_H^{(2)}$	Holding Current	$I_T = 100 \text{ mA}, \text{Gate open}, T_j = 25^\circ C$		MAX	25	50	25	50	mA
I_L	Latching Current	$I_G = 1.2 I_{GT}, T_j = 25^\circ C$	Q1,Q3,Q4	MAX	40	70	40	70	mA
			Q2	MAX	60	80	80	100	mA
$dV/dt^{(2)}$	Critical Rate of Voltage Rise	$V_D = 0.67 \times V_{DRM}, \text{Gate open}$ $T_j = 125^\circ C$		MIN	500	650	650	500	V/ μ s
$(dV/dt)_c^{(2)}$	Critical Rise Rate of Commutating off-state voltage	$(dI/dt)_c = 2.7 \text{ A/ms}$ $T_j = 125^\circ C$		MIN	3	8	5	10	V/ μ s
$V_{TM}^{(2)}$	On-state Voltage	$I_T = 35 \text{ Amp}, t_p = 380 \mu\text{s}, T_j = 25^\circ C$		MAX	1.55				V
$V_{t(o)}^{(2)}$	Threshold Voltage	$T_j = 125^\circ C$		MAX	0.85				V
$r_d^{(2)}$	Dynamic resistance	$T_j = 125^\circ C$		MAX	16				m Ω
I_{DRM}/I_{RRM}	Off-State Leakage Current	$V_D = V_{DRM}, T_j = 125^\circ C$		MAX	2				mA
		$V_R = V_{RRM}, T_j = 25^\circ C$		MAX	5				μ A
$R_{th(j-c)}$	Thermal Resistance Junction-Case	for AC 360° conduction angle			1.0				$^\circ C/W$
$R_{th(j-a)}$	Thermal Resistance Junction-Ambient	$S = 1 \text{ cm}^2$			60				$^\circ C/W$

(1) Minimum I_{GT} is guaranteed at 5% of I_{GT} max.

(2) For either polarity of electrode MT2 voltage with reference to electrode MT1.

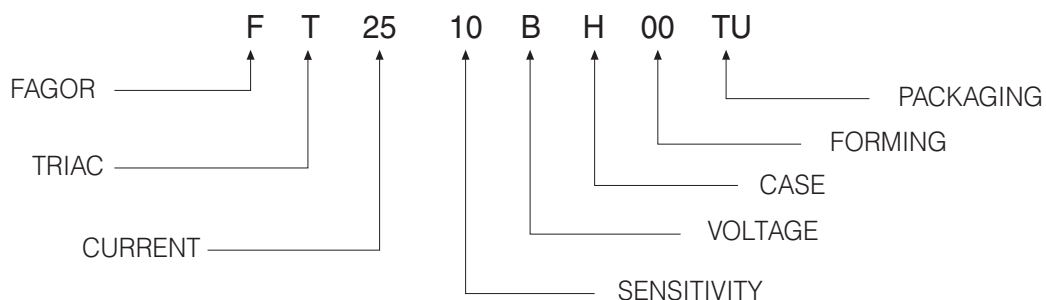
PART NUMBER INFORMATION

STANDARD TRIAC

Fig. 1: Maximum power dissipation versus RMS on-state current (full cycle)

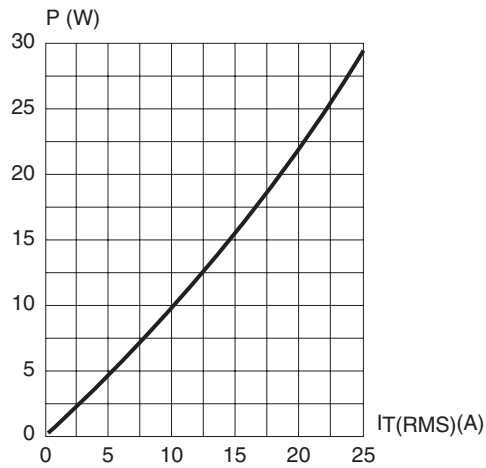

Fig. 2: RMS on-state current versus case temperature (full cycle).

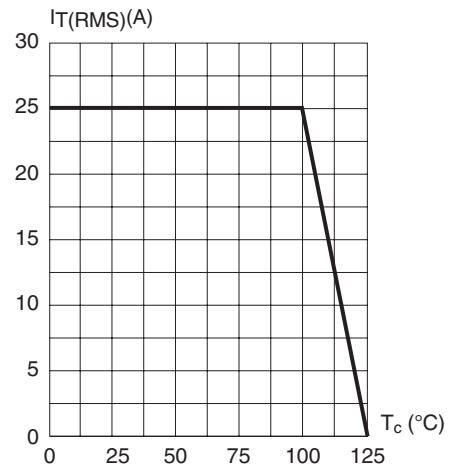

Fig. 3: Relative variation of thermal impedance versus pulse duration.

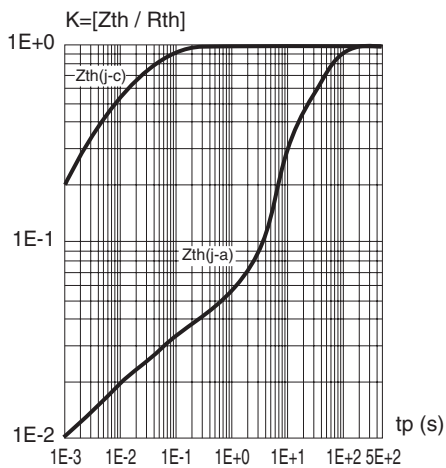

Fig. 4: On-state characteristics (maximum values)

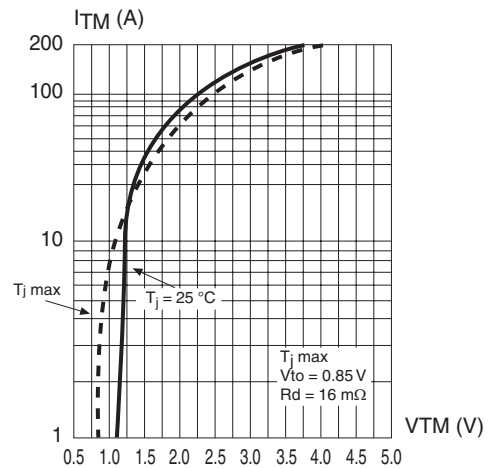

Fig. 5: Surge peak on-state current versus number of cycles

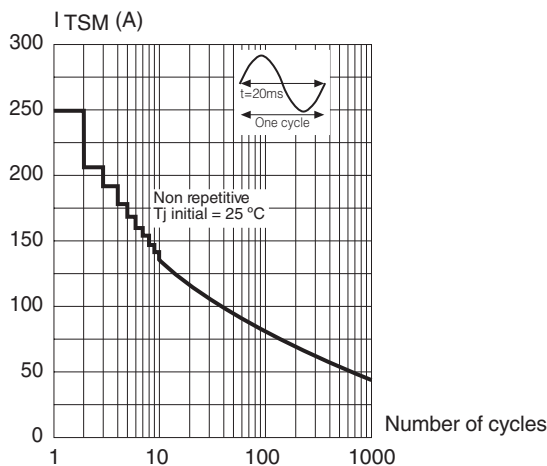
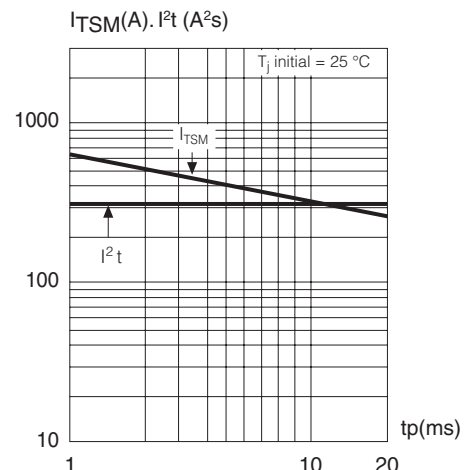

Fig. 6: Non repetitive surge peak on-state current for a sinusoidal pulse with width: $t_p < 20$ ms, and corresponding value of I^2t .



STANDARD TRIAC

Fig. 7: Relative variation of gate trigger current, holding current and latching versus junction temperature (typical values)

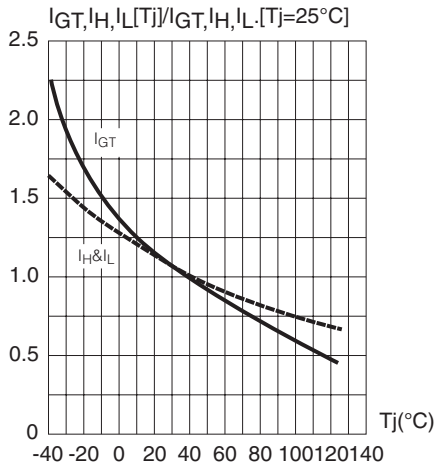

Fig. 8: Relative variation of critical rate of decrease of main current versus junction temperature

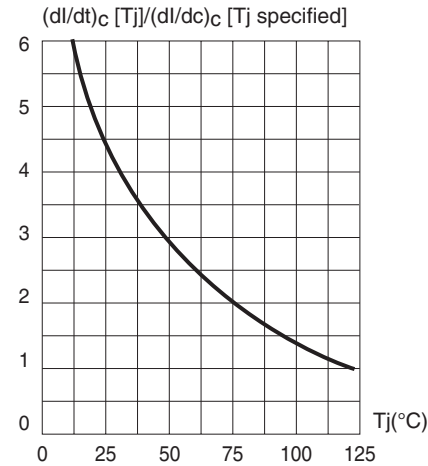
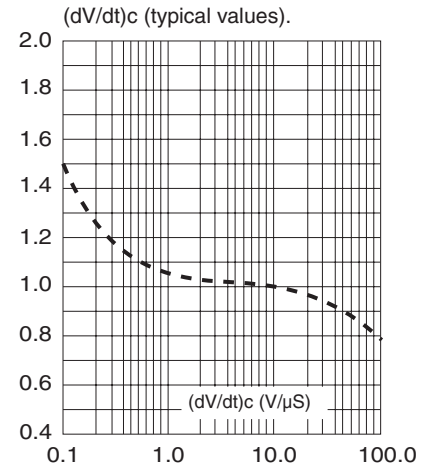
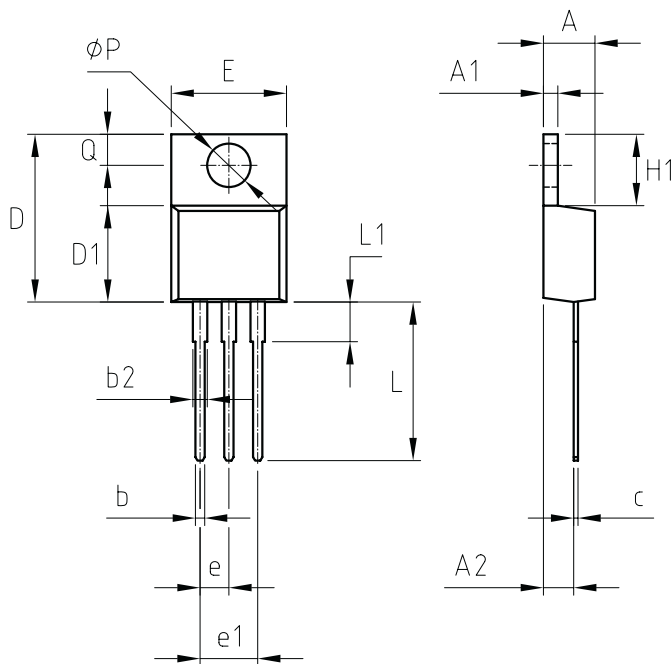

Fig. 9: Relative variation of critical rate of decrease of main current versus



PACKAGE MECHANICAL DATA

TO-220AB



REF.	DIMENSIONS	
	Millimeters	
	Min.	Max.
A	3.56	4.83
A1	0.50	1.40
A2	2.00	2.92
b	0.38	1.02
b2	1.14	1.78
c	0.31	0.61
D	14.22	16.51
D1	8.38	9.02
E	9.65	10.67
e	2.49	2.59
e1	5.03	5.18
H1	5.84	6.86
L	12.70	14.74
L1		6.35
P	3.53	4.09
Q	2.54	3.43

Mounting Torque

1 N.m

(*) Limiting values and life support applications, see Web page.