



TELEDYNE RELAYS

HIGH REPEATABILITY ULTRAMINIATURE CENTIGRID[®] RELAY BROADBAND DC TO RF

**SERIES
RF100
RF103**

NEW

SERIES DESIGNATION	RELAY TYPE
RF100	Repeatable, RF, Centigrid [®] relay
RF103	Sensitive, repeatable, RF, Centigrid [®] relay

INTERNAL CONSTRUCTION

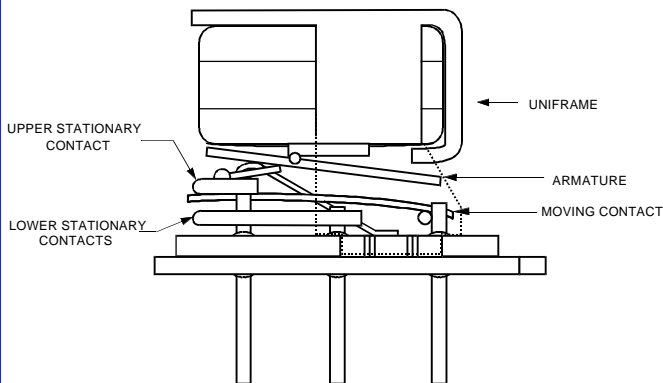

PERFORMANCE FEATURES

The ultraminiature RF100 and RF103 relays are designed to provide improved RF signal repeatability over the frequency range by balancing the aggregate insertion loss elements of the relays' design. Highly suitable for use in attenuator and other RF circuits, the RF 100 and RF103 feature:

- High repeatability.
- Broader bandwidth.
- Metal enclosure for EMI shielding.
- Ground pin option to improve case grounding.
- High isolation between control and signal paths.
- Highly resistant to ESD.

CONSTRUCTION FEATURES

The following unique construction features and manufacturing techniques provide excellent resistance to environmental extremes and overall high reliability.

- Uni-frame motor design provides high magnetic efficiency and mechanical rigidity.
- Minimum mass components and welded construction provide maximum resistance to shock and vibration.
- Dual weld projection provides increased design robustness.
- Advanced cleaning techniques provide maximum assurance of internal cleanliness.
- Gold plated precious metal alloy contacts ensure reliable switching.
- Hermetically sealed . Solderable leads.

ENVIRONMENTAL AND PHYSICAL SPECIFICATIONS

Temperature	-55 °C to +85 °C	
Vibration (General Note 1)	10 G to 500 Hz	
Shock (General Note 1)	30 G, 6 ms. half sine	
Enclosure	Hermetically sealed	
Weight	RF100	0.09 oz. (2.55 g) max.
	RF103	0.16 oz. (4.50 g) max.

SERIES RF100 and RF103

TYPICAL RF CHARACTERISTICS (Notes 1, 2 and 3)

INSERTION LOSS AND VSWR CHARACTERISTICS RF100 and RF103 NORMALLY CLOSED CONTACTS

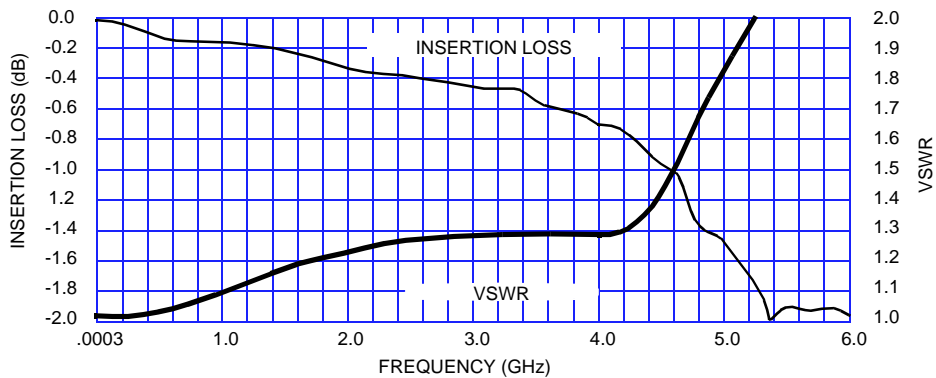

INSERTION LOSS AND VSWR CHARACTERISTICS RF100 and RF103 NORMALLY OPEN CONTACT

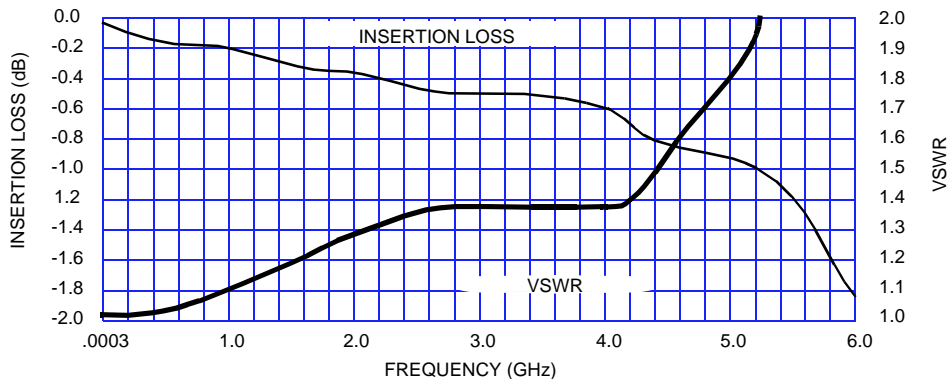

ISOLATION CHARACTERISTICS RF100 AND RF103 RELAYS

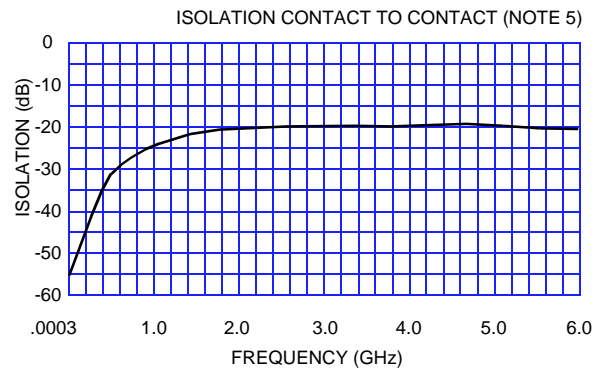
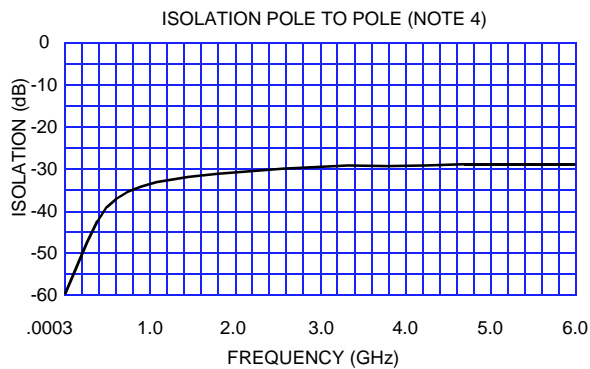

RF Notes:

- Test conditions:
 - Fixture: .031" copper clad, reinforced PTFE, RT/duroid® 6002 with SMA connectors. (RT/duroid® is a registered trademark of Rogers Corporation).
 - Relay header is in contact with but not soldered to ground plane or connected to ground via ground pin.
 - Test performed at room ambient temperature.
 - Terminals not tested were terminated with 50 ohm load.
 - Contact signal level: 20 dBm.
- Data presented herein represents typical characteristics and is not intended for use as specification limits.
- Data is per pole.
- Data is the average from readings taken when the relay is de-energized and energized. Measurement points are from pins 1 and 3 to pins 5 and 7 (de-energized) and pins 1 and 2 to pins 6 and 7 (energized).
- Data is the average from readings taken when the relay is de-energized and energized. Measurement points are from pins 1, 3 to 2 and pins 5,7 to 6 (de-energized) and pins 1,2 to 3 and pins 6,7 to 5 (energized).

SERIES RF100 and RF103

TYPICAL RF INSERTION LOSS REPEATABILITY CHARACTERISTICS (Notes 1 and 2)

REPEATABILITY CHARACTERISTICS RF100 RELAYS

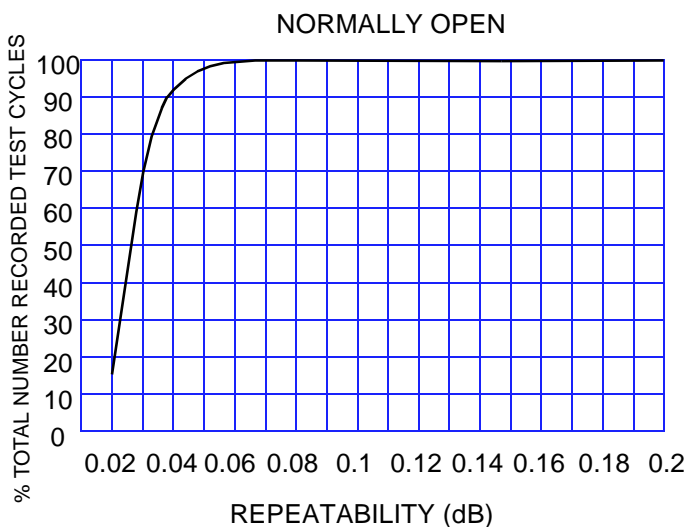
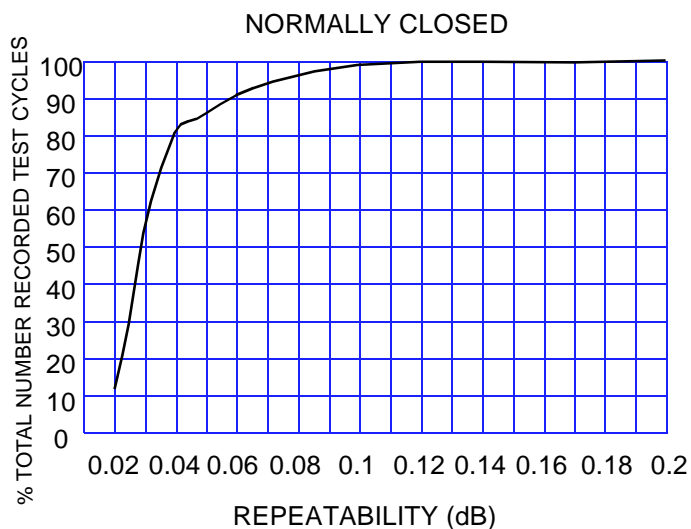

REPEATABILITY CHARACTERISTICS RF103 RELAYS

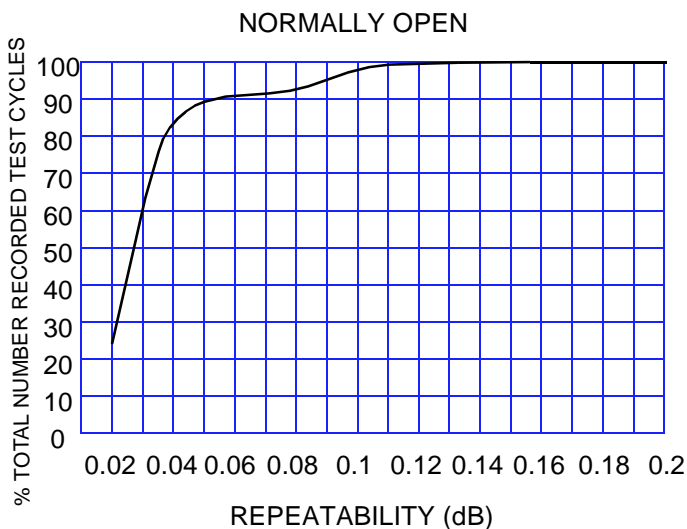
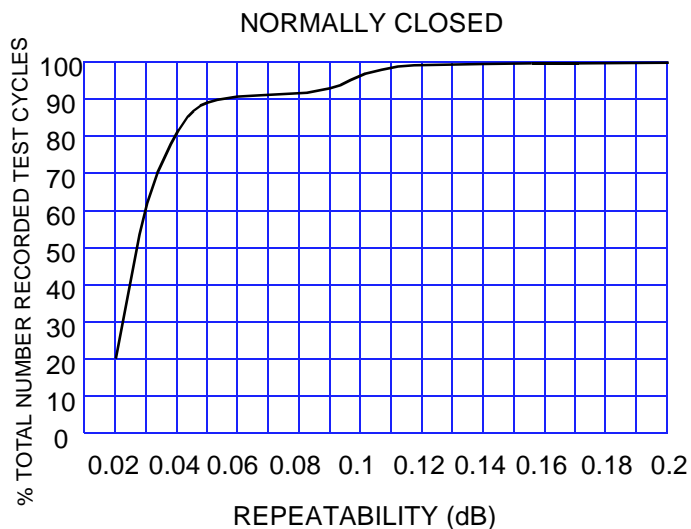

RF Insertion Loss Repeatability Notes

- Test conditions:
 - Fixture: .031" copper clad, reinforced PTFE, RT/duroid 6002[®] with SMA connectors. (RT/duroid[®] is a registered trademark of Rogers Corporation).
 - Relays header is connected to but not soldered to ground plane nor connected via ground pin.
 - Test performed at room ambient temperature.
 - Contact signal level: 20 dBm.
- Data presented herein represents typical characteristics and is not intended to be used as specification limits.
- Insertion loss repeatability measured over frequency range from .3 MHz to 4 GHz.

SERIES RF100 and RF103

GENERAL ELECTRICAL SPECIFICATIONS (@25°C)

Contact arrangement		DPDT
Rated duty		Continuous
Contact resistance		.100 ohm max. initial (measured 1/8" from the header)
Contact load rating		Low level: 10 to 50 μ A, 10 to 50 mV
Contact life rating		10,000,000 cycles typical at low level
Coil operating power		RF100: 450 mW typical @ nominal rated voltage RF103: 200 mW typical @ nominal rated voltage
Operate time	RF100	4.0 ms. max.
	RF103	6.0 ms. max.
Release time	RF100	3.0 ms. max.
	RF103	3.0 ms. max.
Intercontact capacitance		0.4 pF typical
Insulation resistance		1,000 M Ω min. (between mutually isolated terminals)
Dielectric strength		350 VRMS / 60 Hz @ atmospheric pressure

DETAILED ELECTRICAL SPECIFICATIONS (@ 25°C)

BASE PART NUMBERS		RF100-5 RF103-5	RF100-12 RF103-12
Coil voltage, nominal, VDC		5.0	12.0
Coil resistance, ohms \pm 20%	RF100	50	390
	RF103	100	800
Pick-up voltage max, VDC		3.6	9.0

OUTLINE DIMENSIONS

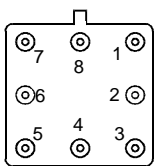

TERMINAL NUMBERING

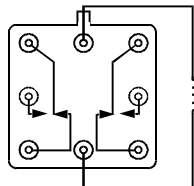

SCHEMATIC

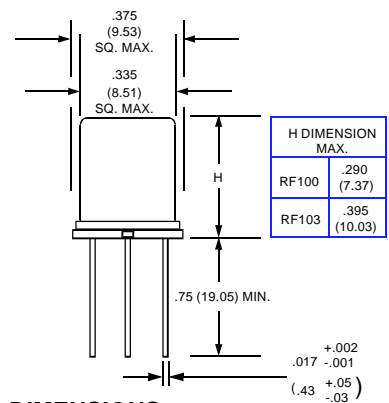
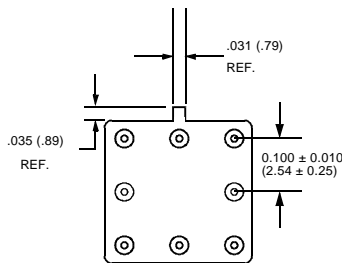

EXTERNAL DIMENSIONS

- TERMINAL NUMBERING AND SCHEMATIC ARE AS VIEWED FROM THE TERMINALS.
- DIMENSIONS ARE IN INCHES (MILLIMETERS).
- SCHEMATIC AND EXTERNAL DIMENSIONS SHOWN WITHOUT GROUND PINS.
- TO ORDER THE CASE GROUND OPTION, AFTER THE SERIES DESIGNATOR, ADD "Y" TO THE PART NUMBER FOR TAB POSITION OR "Z" TO THE PART NUMBER FOR CENTER POSITION.

EXAMPLE: RF1##Y-COIL VOLTAGE

GENERAL NOTES

1. Relays will exhibit no contact chatter in excess of 10 μ s or transfer in excess of 1 μ s.