

WNMD2162A

Dual N-Channel, 20V, 4.8A, Power MOSFET

V _{DS} (V)	R _{ds(on)} (Ω)
20	0.014@ V _{GS} =4.5V
	0.015@ V _{GS} =3.1V
	0.016@ V _{GS} =2.5V
ESD Protected	

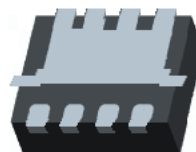

PDFN2.9x2.8-8L

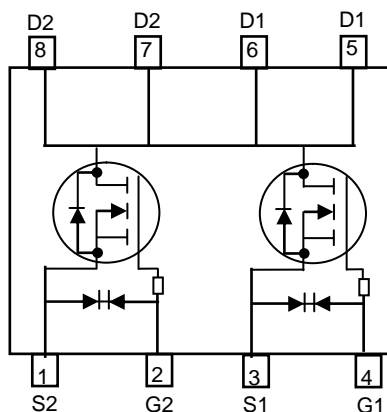

Pin configuration (Top view)

Descriptions

The WNMD2162A is Dual N-Channel enhancement MOS Field Effect Transistor. Uses advanced trench technology and design to provide excellent R_{DS(ON)} with low gate charge. This device is suitable for use in DC-DC conversion, power switch and charging circuit. Standard Product WNMD2162A is Pb-free and Halogen-free.

Features

- Trench Technology
- Supper high density cell design
- Excellent ON resistance for higher DC current
- Extremely Low Threshold Voltage
- Small package PDFN2.9x2.8-8L

Applications

- Driver for Relay, Solenoid, Motor, LED etc.
- DC-DC converter circuit
- Power Switch
- Load Switch
- Charging

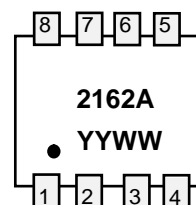

2162A = Device Code
 YY = Year
 WW = Week

Marking

Order information

Device	Package	Shipping
WNMD2162A-8/TR	PDFN 2.9×2.8-8L	3000/Reel&Tape

Absolute Maximum ratings

Parameter	Symbol	10 S	Steady State	Unit	
Drain-Source Voltage	V_{DS}	20		V	
Gate-Source Voltage	V_{GS}	±10			
Continuous Drain Current ^{a,e}	I_D	$T_A=25^{\circ}C$	4.8	4.5	A
		$T_A=70^{\circ}C$	4.8	3.6	
Maximum Power Dissipation ^a	P_D	$T_A=25^{\circ}C$	1.7	0.9	W
		$T_A=70^{\circ}C$	1.1	0.6	
Continuous Drain Current ^{b,e}	I_D	$T_A=25^{\circ}C$	4.8	4.1	A
		$T_A=70^{\circ}C$	4.7	3.3	
Maximum Power Dissipation ^b	P_D	$T_A=25^{\circ}C$	1.6	0.8	W
		$T_A=70^{\circ}C$	1.0	0.5	
Pulsed Drain Current ^c	I_{DM}	40		A	
Operating Junction Temperature	T_J	-55~+150		$^{\circ}C$	
Lead Temperature	T_L	260		$^{\circ}C$	
Storage Temperature Range	T_{stg}	-55 to 150		$^{\circ}C$	

Thermal resistance ratings

Single Operation					
Parameter	Symbol	Typical	Maximum	Unit	
Junction-to-Ambient Thermal Resistance ^a	$R_{\theta JA}$	$t \leq 10$ s	61	72	$^{\circ}C/W$
		Steady State	102	128	
Junction-to-Ambient Thermal Resistance ^b	$R_{\theta JA}$	$t \leq 10$ s	65	75	
		Steady State	120	148	
Junction-to-Case Thermal Resistance	$R_{\theta JC}$	54	63		

- a Surface mounted on FR-4 Board using 1 square inch pad size, 1oz copper;.
- b Surface mounted on FR-4 board using minimum pad size, 1oz copper;.
- c Pulse width<380 μ s, Duty Cycle<2%;.
- d Maximum junction temperature $T_J=150^{\circ}C$;.
- e Current rating is limited by wire-bonding.

Electronics Characteristics (Ta=25°C, unless otherwise noted)

Parameter	Symbol	Test Conditions	Min	Typ	Max	Unit
OFF CHARACTERISTICS						
Drain-to-Source Breakdown Voltage	BV_{DSS}	$V_{GS} = 0\text{ V}, I_D = 250\mu\text{A}$	20			V
Zero Gate Voltage Drain Current	I_{DSS}	$V_{DS} = 16\text{ V}, V_{GS} = 0\text{ V}$			1	μA
Gate-to-source Leakage Current	I_{GSS}	$V_{DS} = 0\text{ V}, V_{GS} = \pm 10\text{ V}$			± 5	μA
ON CHARACTERISTICS						
Gate Threshold Voltage	$V_{GS(TH)}$	$V_{GS} = V_{DS}, I_D = 250\mu\text{A}$	0.4	0.7	1.0	V
Drain-to-source On-resistance	$R_{DS(on)}$	$V_{GS} = 4.5\text{ V}, I_D = 4.8\text{ A}$		14	22	m Ω
		$V_{GS} = 3.1\text{ V}, I_D = 4.0\text{ A}$		15	28	
		$V_{GS} = 2.5\text{ V}, I_D = 3.0\text{ A}$		16	32	
Forward Transconductance	g_{FS}	$V_{DS} = 5.0\text{ V}, I_D = 4.8\text{ A}$		17		S
CHARGES, CAPACITANCES AND GATE RESISTANCE						
Input Capacitance	C_{ISS}	$V_{GS} = 0\text{ V}, f = 1.0\text{ MHz}, V_{DS} = 10\text{ V}$		1371		pF
Output Capacitance	C_{OSS}			185		
Reverse Transfer Capacitance	C_{RSS}			172		
Total Gate Charge	$Q_{G(TOT)}$	$V_{GS} = 4.5\text{ V}, V_{DD} = 10\text{ V}, I_D = 4.8\text{ A}$		18.9		nC
Threshold Gate Charge	$Q_{G(TH)}$			1.3		
Gate-to-Source Charge	Q_{GS}			2.8		
Gate-to-Drain Charge	Q_{GD}			6.4		
SWITCHING CHARACTERISTICS						
Turn-On Delay Time	$t_d(ON)$	$V_{GS} = 4.5\text{ V}, V_{DD} = 6\text{ V}, I_D = 4.8\text{ A}, R_G = 6\ \Omega$		29		ns
Rise Time	t_r			35		
Turn-Off Delay Time	$t_d(OFF)$			260		
Fall Time	t_f			125		
BODY DIODE CHARACTERISTICS						
Forward Voltage	V_{SD}	$V_{GS} = 0\text{ V}, I_S = 1.0\text{ A}$		0.65	1.5	V

Typical Characteristics (Ta=25°C, unless otherwise noted)

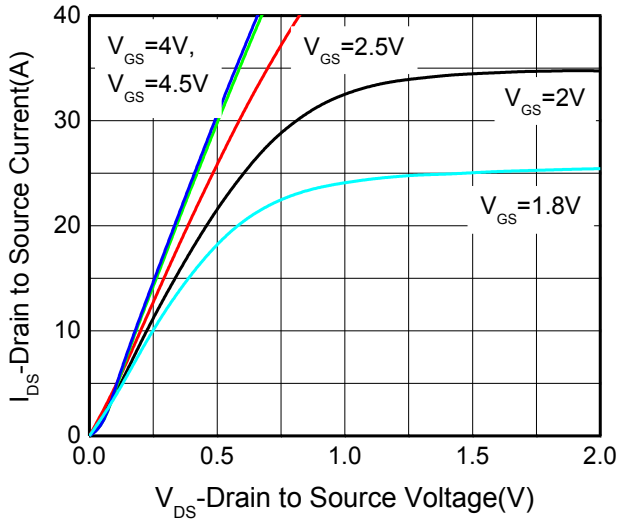

Output characteristics

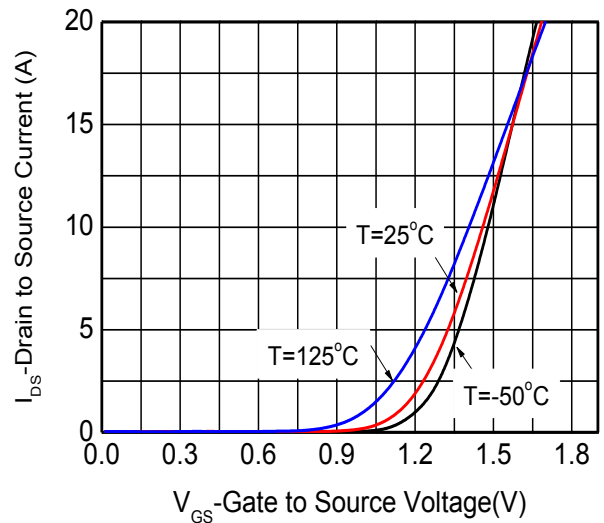

Transfer characteristics

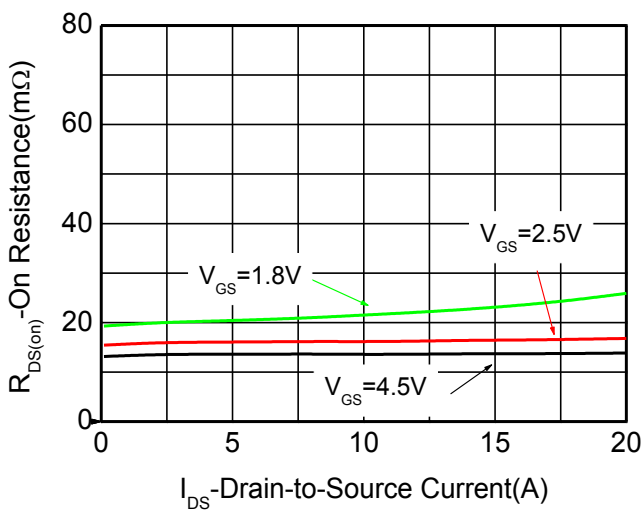

On-Resistance vs. Drain current

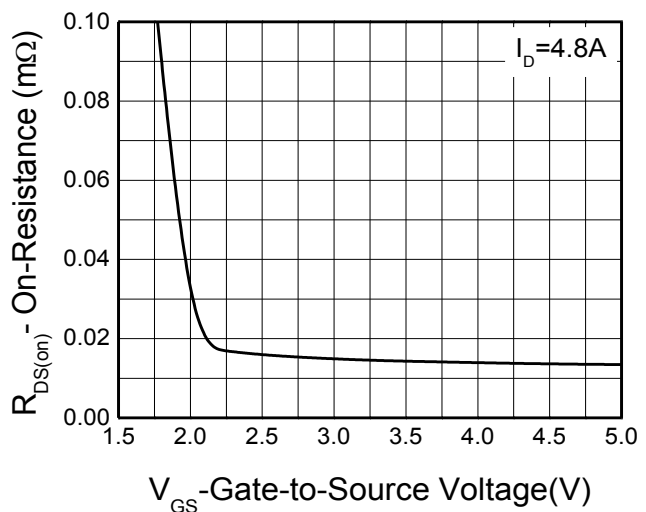

On-Resistance vs. Gate-to-Source voltage

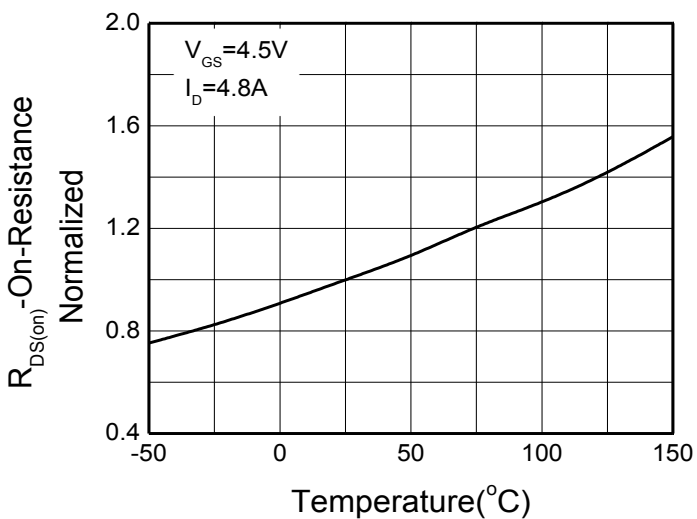

On-Resistance vs. Junction temperature

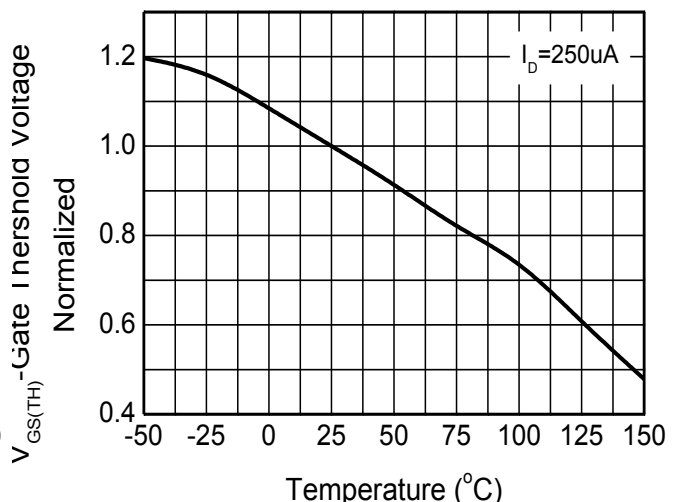

Threshold voltage vs. Temperature

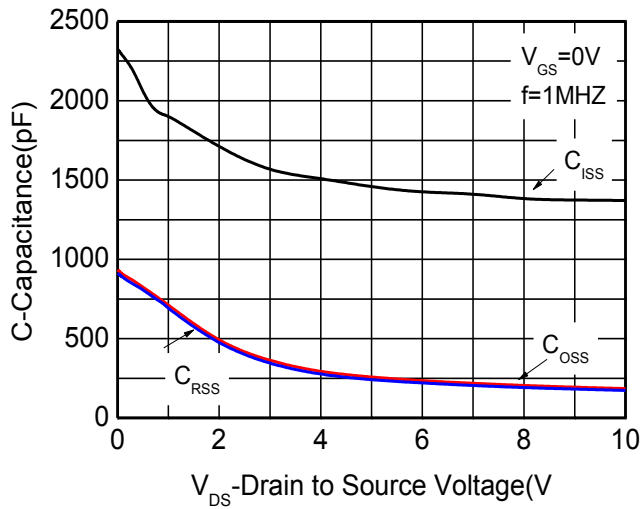

Capacitance

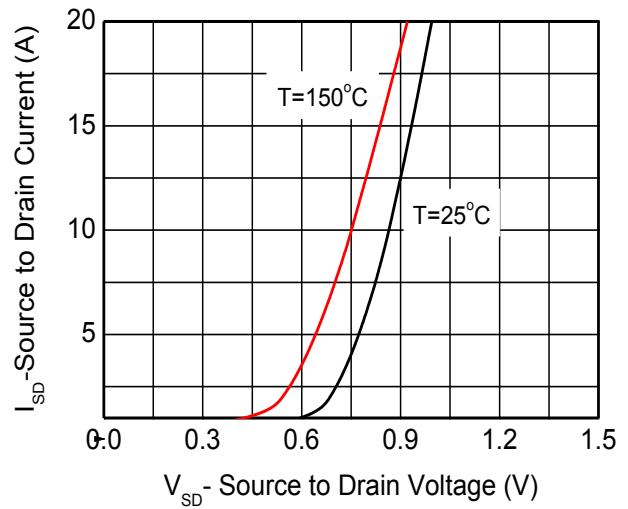

Body diode forward voltage

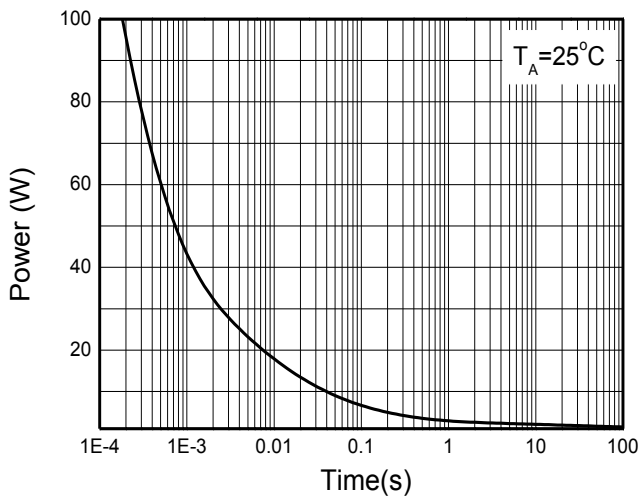

Single pulse power

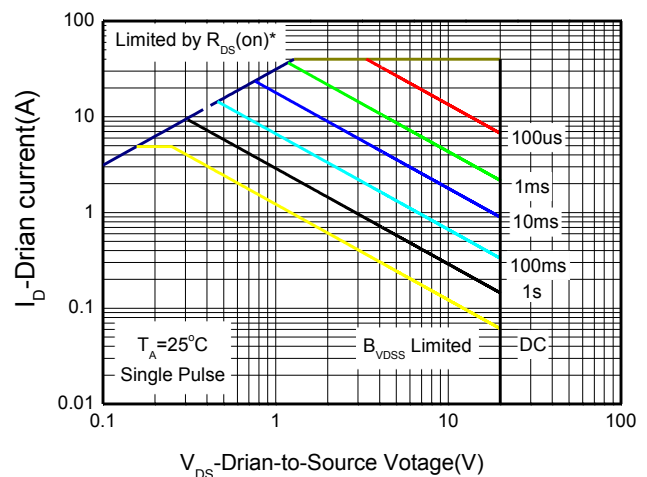

* $V_{GS} >$ minimum V_{GS} at which $R_{DS(on)}$ is specified

Safe operating power(Note.e)

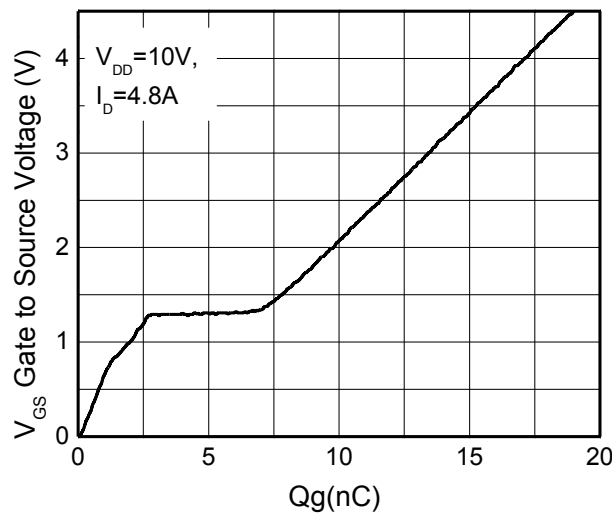

Gate Charge Characteristics

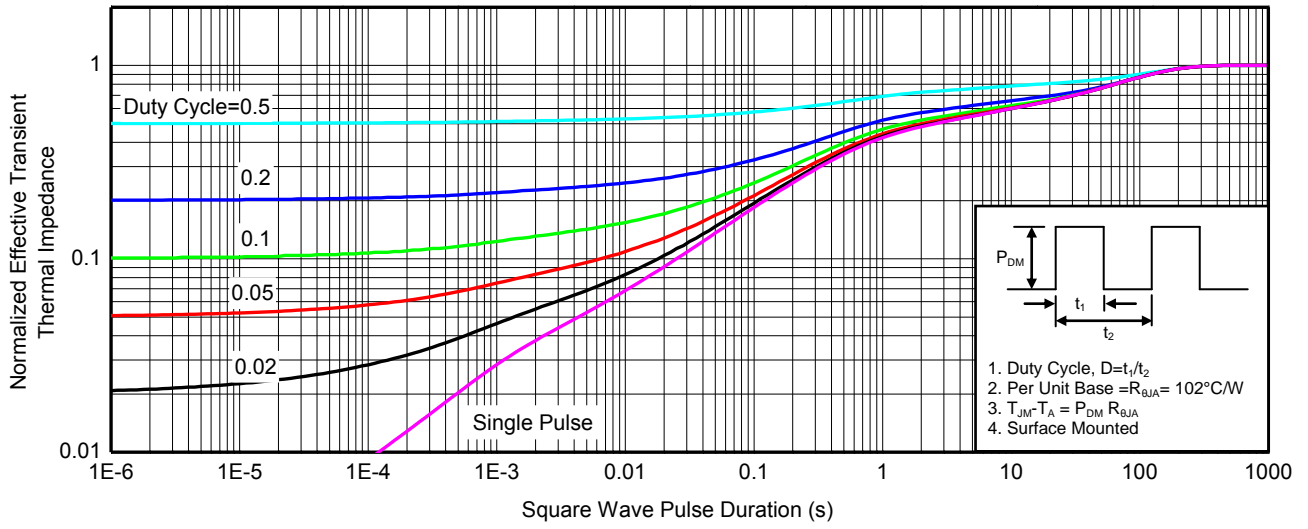

Transient thermal response (Junction-to-Ambient)

Package outline dimensions (ALL DIMENSIONS DO NOT INCLUDE MOLD FLASH OR PROTRUSIONS)

PDFN2.9x2.8-8L

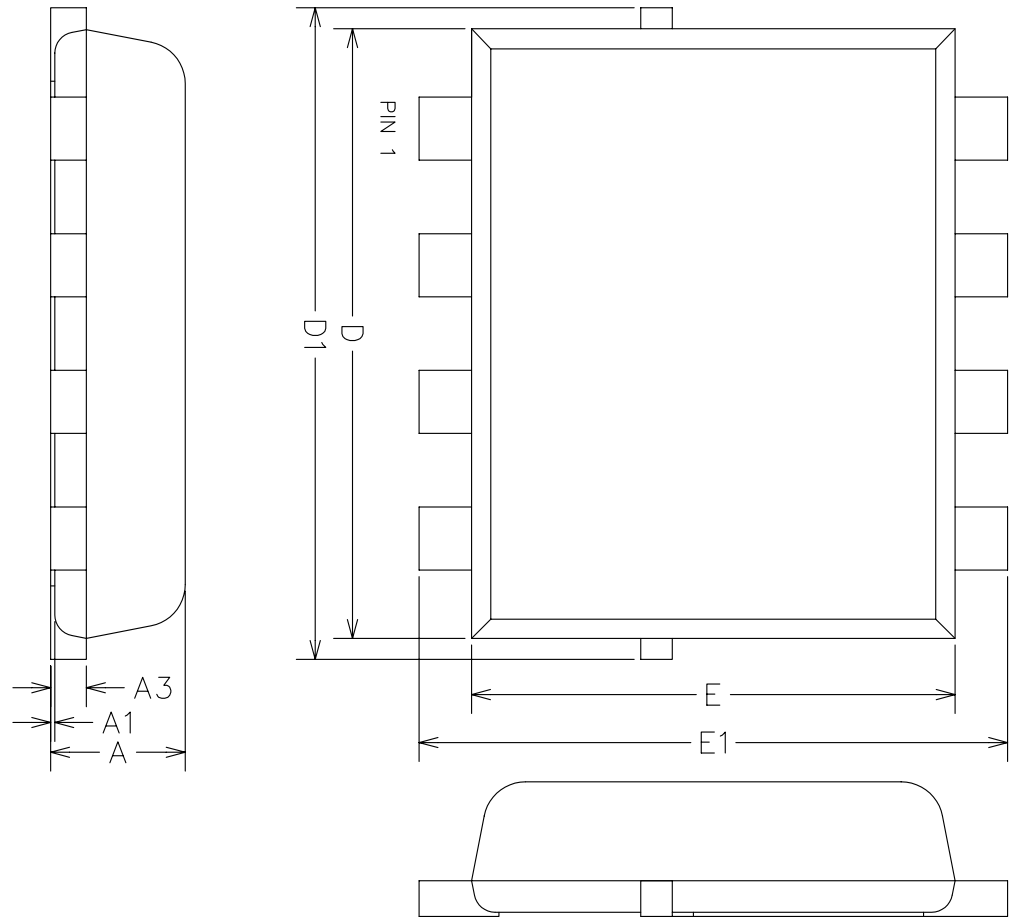

Symbol	Dimensions in millimeter		
	Min.	Typ.	Max.
A	0.600	0.640	0.680
A1	0.000	0.020	0.050
A3	0.15REF		
b	0.200	0.300	0.400
D	2.800	2.900	3.000
E	2.200	2.300	2.400
D1	-	-	3.200
E1	2.600	2.800	3.000
D2	2.300	2.400	2.500
E2	1.150	1.250	1.350
e	0.550	0.650	0.750
K	0.500	-	-
L	0.280	0.380	0.480

