

25V N-Channel Enhancement Mode MOSFET

$V_{DS}=25V$

$R_{DS(ON)}, V_{GS}@10V, I_{DS}@30A \leq 9m\Omega$

$R_{DS(ON)}, V_{GS}@5V, I_{DS}@15A \leq 18m\Omega$

FEATURES

Advanced trench process technology

High density cell design for ultra low on-resistance

Specially designed for DC/DC converters and motor drivers

Fully characterized avalanche voltage and current

APPLICATIONS

- Motherboard (V-Core)
- DC/DC Converter
- Load Switch
- LCD Display inverter
- IPC

PIN CONFIGURATION

(TO-252)

Top View

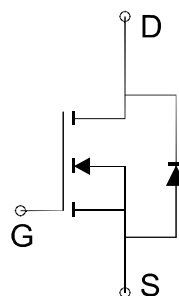
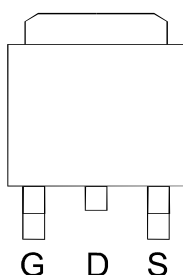

Absolute Maximum Ratings ($T_A=25^\circ C$ Unless Otherwise Noted)

Parameter		Symbol	Limit	Unit
Drain-Source Voltage		V_{DSS}	25	V
Gate-Source Voltage		V_{GSS}	± 20	V
Continuous Drain Current($T_J=150^\circ C$)*	$T_C=25^\circ C$	I_D	53	A
Pulsed Drain Current		I_{DM}	100	A
Maximum Power Dissipation	$T_C=25^\circ C$	P_D	40	W
	$T_C=70^\circ C$		25	
Operating Junction and Storage Temperature Range		T_J, T_{stg}	-55 to 150	$^\circ C$
Avalanche Energy with Single Pulse($L=0.1mH, R_g=25\Omega$)		E_{AS}	50	mJ
Thermal Resistance-Junction to Ambient*	$R_{\theta JA}$	$T \leq 10$ sec	15	$^\circ C/W$
		Steady State	40	
Thermal Resistance-Junction to Case		$R_{\theta JC}$	3.1	$^\circ C/W$

*The device mounted on 1in² FR4 board with 2 oz copper

25V N-Channel Enhancement Mode MOSFET

Electrical Characteristics (TA=25°C Unless Otherwise Specified)

Symbol	Parameter	Limit	Min	Typ	Max	Unit
STATIC						
BV _{DSS}	Drain-Source Breakdown Voltage	V _{GS} =0V, I _D =250 μA	25			V
V _{GS(th)}	Gate Threshold Voltage	V _{DS} =V _{GS} , I _D =250 μA	1		3	V
I _{GSS}	Gate-Body Leakage	V _{DS} =0V, V _{GS} =±20V			±100	nA
I _{DSS}	Zero Gate Voltage Drain Current	V _{DS} =25V, V _{GS} =0V			1	μA
R _{DS(ON)}	Drain-Source On-Resistance	V _{GS} =10V, I _D =30A		6.7	9	mΩ
		V _{GS} = 5V, I _D =15A		13	18	
DYNAMIC						
Q _g	Total Gate Charge	V _{DS} =15V, V _{GS} =10V, I _D =25A		22		nC
Q _g	Total Gate Charge	V _{DS} =15V, V _{GS} =4.5V, I _D =25A		11		
Q _{gs}	Gate-Source Charge			5.4		
Q _{gd}	Gate-Drain Charge			5.5		
C _{iss}	Input Capacitance	V _{DS} =15V, V _{GS} =0V, f=1MHz		840		pF
C _{oss}	Output Capacitance			180		
C _{rss}	Reverse Transfer Capacitance			55		
R _g	Gate Resistance	V _{DS} =0V, V _{GS} =0V, f=1MHz		1		Ω
t _{d(on)}	Turn-On Delay Time	R _L =15Ω, V _{GEN} =10V, I _D =1A V _{DD} =15V, R _G =3Ω		13.5		ns
t _r	Turn-On Rise Time			13		
t _{d(off)}	Turn-Off Delay Time			42		
t _f	Turn-Off Fall Time			4		
SOURCE-DRAIN DIODE						
I _s	Max.Diode Forward Current				20	A
V _{SD}	Diode Forward Voltage	I _s =20A, V _{GS} =0V		0.87	1.5	V

Note: Pulse test: pulse width ≤ 300us, duty cycle ≤ 2%

Typical Characteristics (T_J = 25°C Noted)

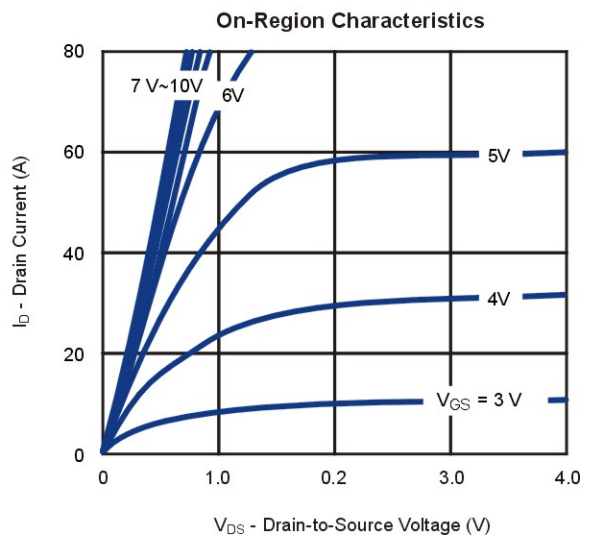
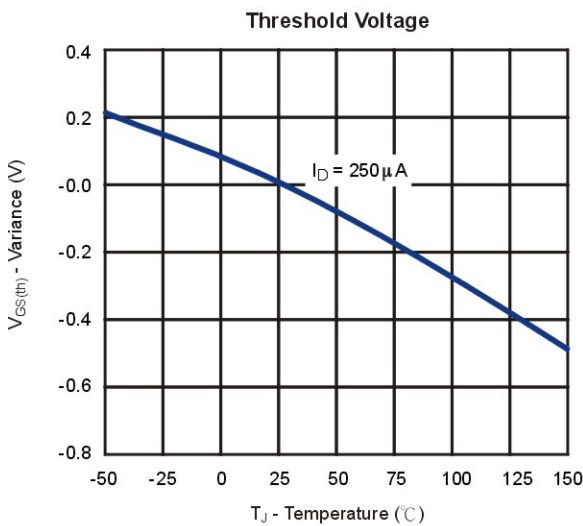
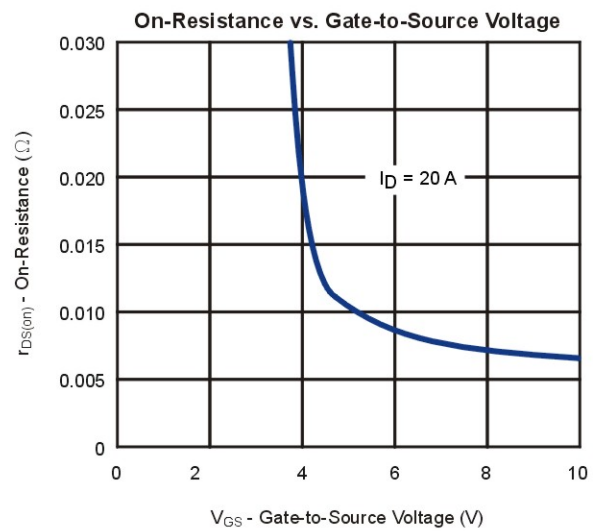
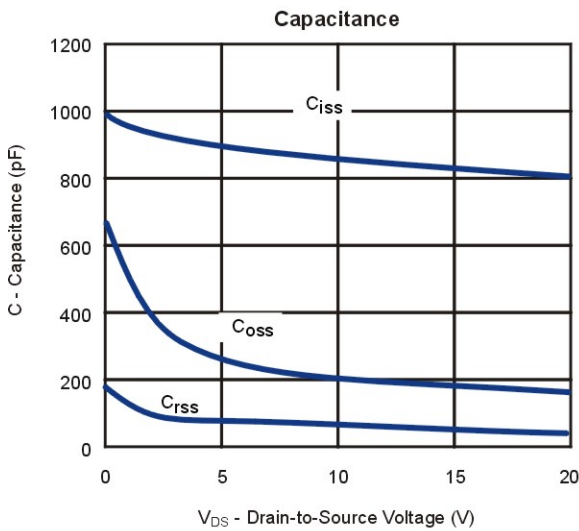
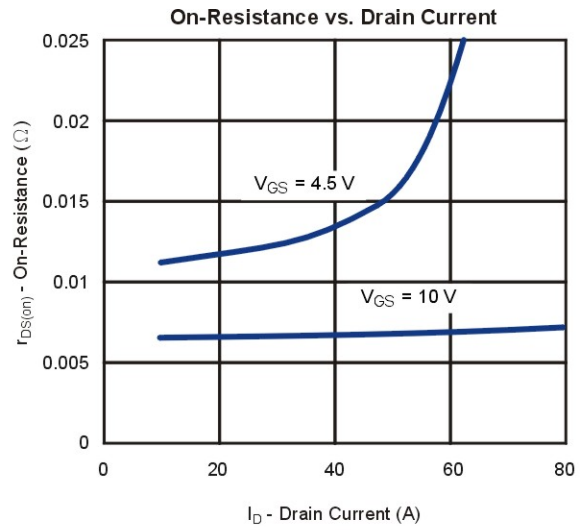
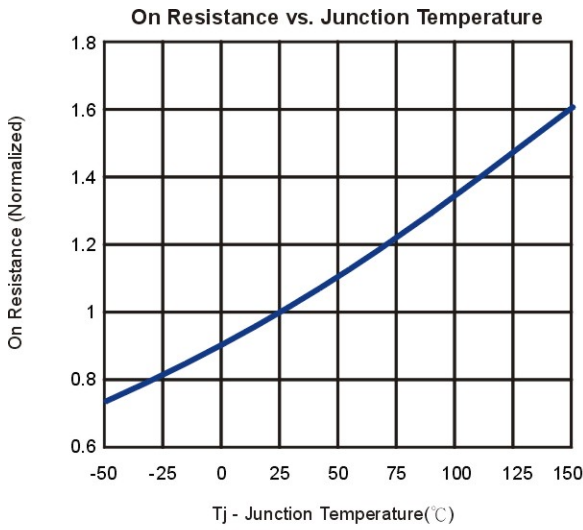

25V N-Channel Enhancement Mode MOSFET

Typical Characteristics (T_J = 25°C Noted)

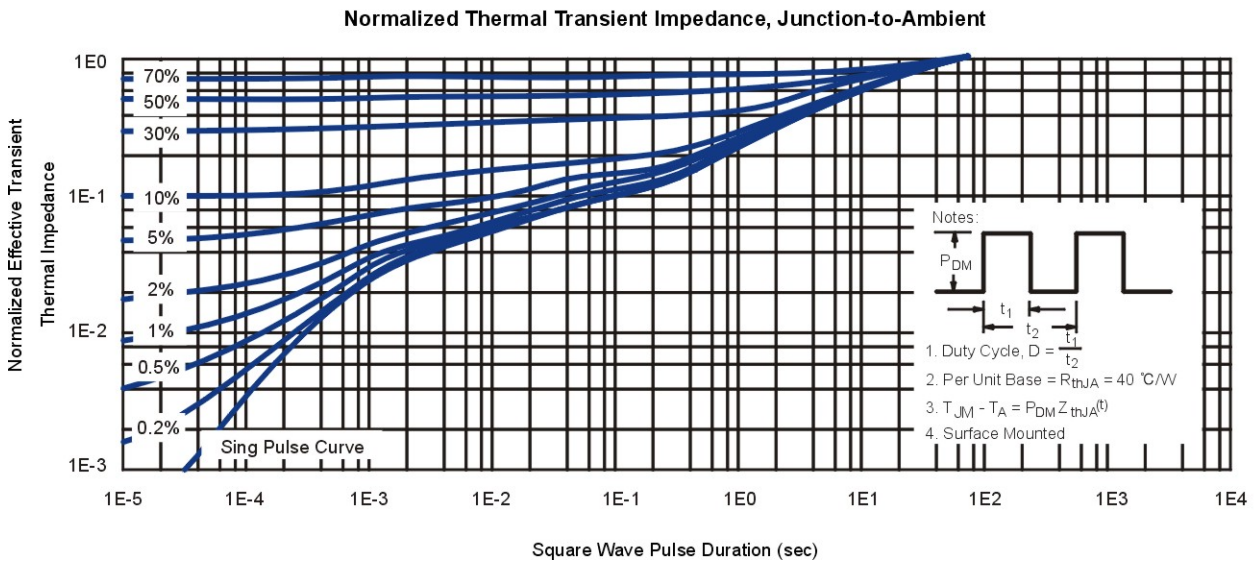
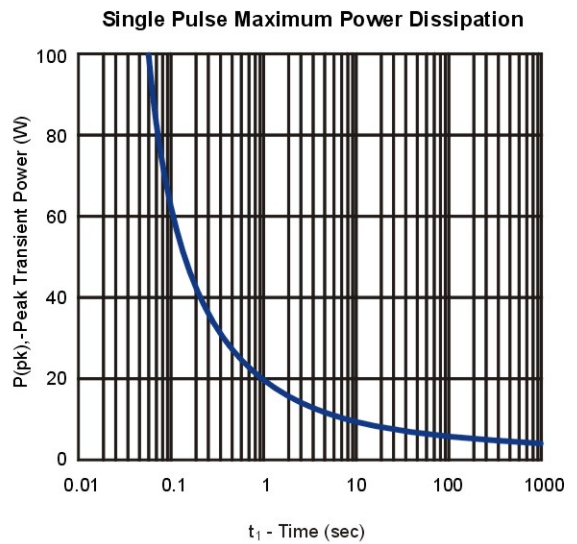
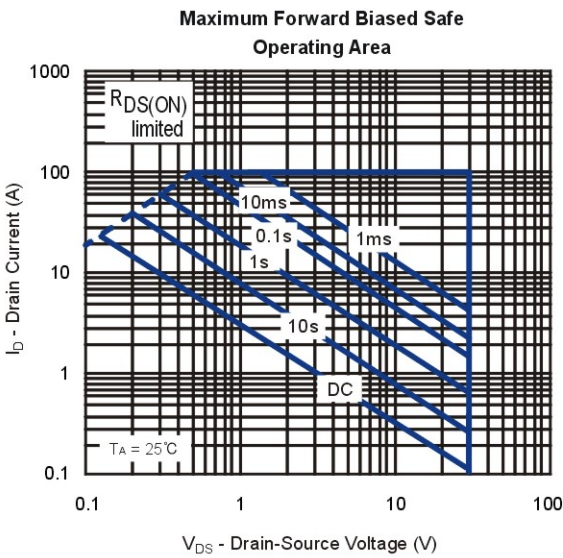
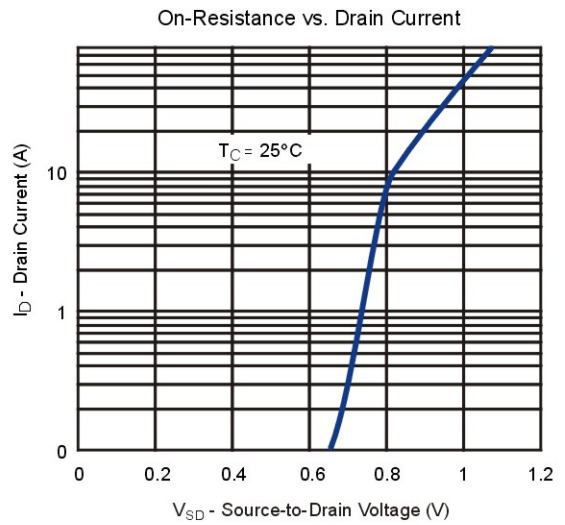
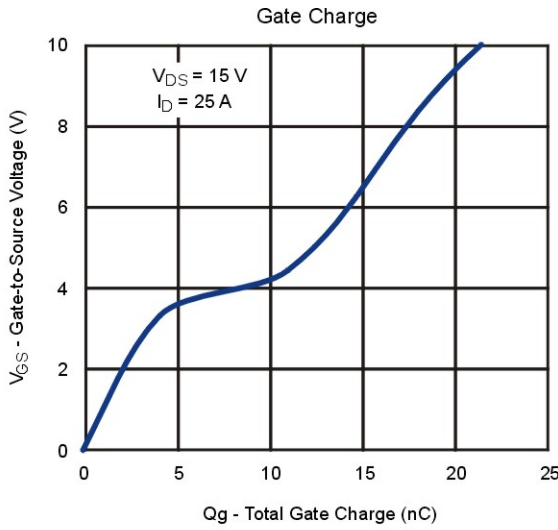

TO-252 Package Outline

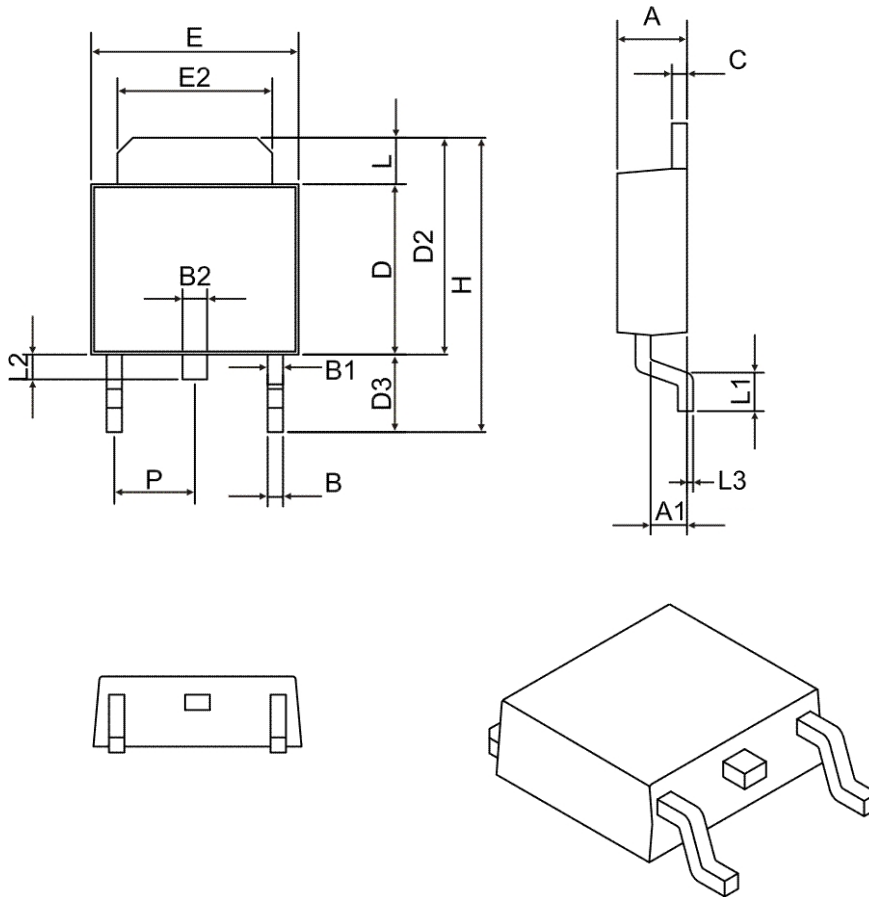

SYMBOL	MILLIMETERS (mm)	
	MIN	MAX
A	2.00	2.50
A1	0.90	1.30
B	0.50	0.85
B1	0.50	0.80
B2	0.50	1.00
C	0.40	0.60
D	5.20	5.70
D2	6.50	7.30
D3	2.20	3.00
H	9.50	10.50
E	6.30	6.80
E2	4.50	5.50
L	1.30	1.70
L1	0.90	1.70
L2	0.50	1.10
L3	0	0.30
P	2.00	2.80