

# 40V 400mA Step-Down Switching Regulator with Dual Fault Protected Tracking LDOs

## FEATURES

- **Dual Low Dropout Linear Tracking Regulators**  
200mA Outputs with Programmable Current Limits  
1.6V to 45V Input Range  
Fault Protected to  $\pm 45V$
- **Triple Output Supply from a Single Input Requires Only One Inductor**
- $I_Q = 50\mu A$  at  $12V_{IN}$  to 6V and 5V with No Load
- **Buck Regulator:**  
Low Ripple ( $<15mV_{p-p}$ ) Burst Mode Operation®  
400mA Output with Internal Power Switch  
4.3V to 40V Input Operation Range (60V Max)
- Adjustable 250kHz to 2.2MHz Switching Frequency
- Power Good Indicator
- Available in a Thermally-Enhanced 16-Lead MSOP Package

## APPLICATIONS

- Fault-Protected Sensor Supply
- Automotive and Industrial Supplies
- Power for Portable Instrumentation

LT, LT, LTC, LTM, Burst Mode, Linear Technology and the Linear logo are registered trademarks of Linear Technology Corporation. All other trademarks are the property of their respective owners.

## DESCRIPTION

The LT<sup>®</sup>3668 is a monolithic triple power supply composed of a 400mA buck switching regulator and two 200mA low dropout linear tracking regulators (LDOs). This provides a complete and robust power solution for applications that require the power supply of a sensor to tightly track the power supply of a measurement ASIC.

Each tracking LDO supplies 200mA of output current with a typical dropout voltage of 340mV, and each LDO has an accurate resistor programmable current limit.

Internal protection circuitry includes reverse-battery protection, current limiting, thermal limiting and reverse current protection.

The buck regulator includes a high efficiency switch, a boost diode, and the necessary oscillator, control and logic circuitry. Current mode topology is used for fast transient response and good loop stability. Low ripple Burst Mode operation maintains high efficiency at low output currents while keeping output ripple below 15mV in a typical application.

The LT3668 is available in a thermally-enhanced 16-lead MSOP package with exposed pad for low thermal resistance.

## TYPICAL APPLICATION

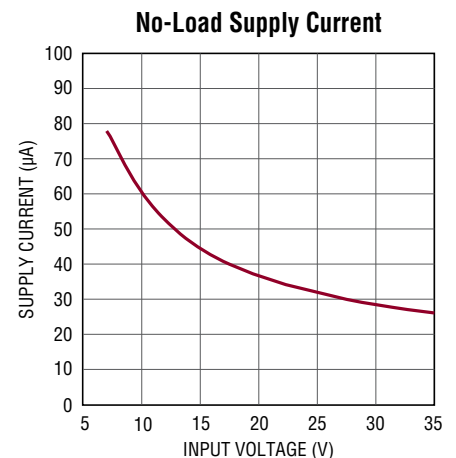
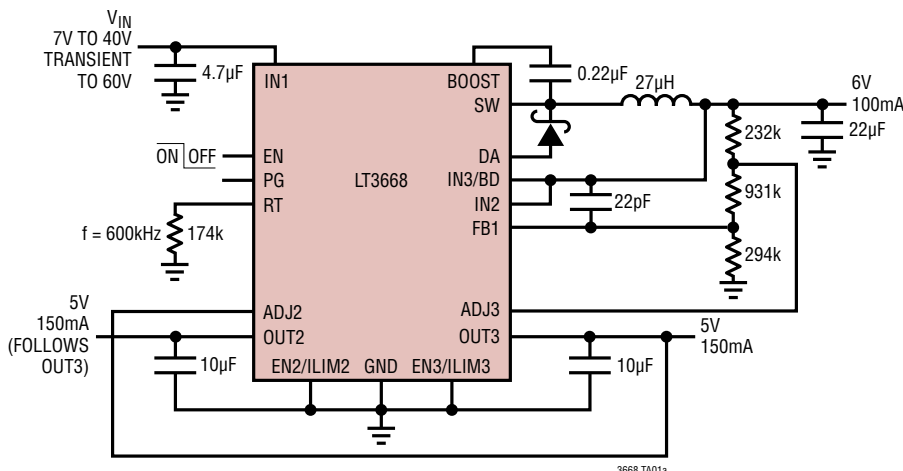

## ABSOLUTE MAXIMUM RATINGS

(Notes 1, 2)

ADJ2, ADJ3 Voltage.....	±45V
OUT2, OUT3 Voltage.....	±45V
IN2 Voltage.....	±45V
OUT2 – IN2 Differential Voltage.....	±45V
OUT3 – IN3/BD Differential Voltage.....	±45V
OUT2 – ADJ2 Differential Voltage.....	±45V
OUT3 – ADJ3 Differential Voltage.....	±45V
IN1, EN Voltage (Note 3).....	60V
IN1 Reverse Voltage.....	–0.3V
EN Pin Current.....	–1mA
IN3/BD Voltage.....	30V
BOOST Pin Voltage.....	50V
BOOST Pin Above SW Pin.....	30V
RT Voltage.....	2V
FB1 Voltage.....	6V
EN2/ILIM2, EN3/ILIM3 Voltage.....	4V
PG Voltage.....	30V
Operating Junction Temperature Range (Notes 4, 5)	
E-, I-Grades.....	–40°C to 125°C
Storage Temperature Range.....	–65°C to 150°C
Lead Temperature (Soldering, 10 sec).....	300°C

## PIN CONFIGURATION

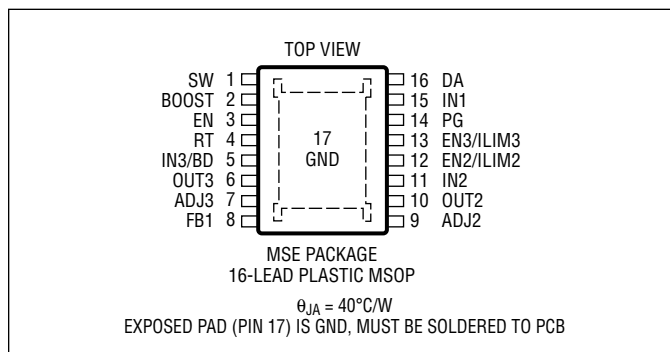

## ORDER INFORMATION

LEAD FREE FINISH	TAPE AND REEL	PART MARKING	PACKAGE DESCRIPTION	TEMPERATURE RANGE
LT3668EMSE#PBF	LT3668EMSE#TRPBF	3668	16-Lead Plastic MSOP	–40°C to 125°C
LT3668IMSE#PBF	LT3668IMSE#TRPBF	3668	16-Lead Plastic MSOP	–40°C to 125°C

Consult LTC Marketing for parts specified with wider operating temperature ranges. \*The temperature grade is identified by a label on the shipping container. Consult LTC Marketing for information on non-standard lead based finish parts.

For more information on lead free part marking, go to: <http://www.linear.com/leadfree/>

For more information on tape and reel specifications, go to: <http://www.linear.com/tapeandreel/>

**ELECTRICAL CHARACTERISTICS** The ● denotes the specifications which apply over the full operating temperature range, otherwise specifications are at  $T_A = 25^\circ\text{C}$ .  $V_{IN1} = 12\text{V}$  unless otherwise noted. (Note 4)

PARAMETER	CONDITIONS		MIN	TYP	MAX	UNITS
$V_{IN1}$ Undervoltage Lockout (Note 6)	$V_{IN2} = 0\text{V}$ , $V_{IN3/BD} = 0\text{V}$	●		4	4.3	V
$V_{IN1}$ Overvoltage Lockout		●	40	42	44	V
$V_{IN2}$ Undervoltage Lockout (Note 6)	$V_{IN1} = 3.5\text{V}$ , $V_{IN3/BD} = 0\text{V}$	●		4	4.3	V
Quiescent Current from IN1	$V_{EN} = 0.3\text{V}$ $V_{EN} = 12\text{V}$ , $V_{IN2} = 0\text{V}$ , Not Switching	●		0.01 13	1 30	$\mu\text{A}$ $\mu\text{A}$
Quiescent Current from IN2	$V_{EN} = 0.3\text{V}$ $V_{EN} = 12\text{V}$ , $V_{IN1} = 0\text{V}$ , $V_{IN2} = 5\text{V}$	●		0.01 38	1 80	$\mu\text{A}$ $\mu\text{A}$
Quiescent Current from IN1 + IN2	$V_{EN} = 0.3\text{V}$ , $V_{IN2} = 5\text{V}$ $V_{EN} = 12\text{V}$ , $V_{IN2} = 5\text{V}$ , Not Switching	●		0.01 40	1 90	$\mu\text{A}$ $\mu\text{A}$
Quiescent Current from IN3/BD	$V_{EN} = 0.3\text{V}$ , $V_{IN3/BD} = 5\text{V}$ $V_{EN} = 12\text{V}$ , $V_{IN3/BD} = 5\text{V}$	●		0.01 25	1 60	$\mu\text{A}$ $\mu\text{A}$
EN Pin Current	$V_{EN} = 12\text{V}$			0.6	2	$\mu\text{A}$
EN Input Threshold			0.3		1.1	V
<b>Power Good Pin PG</b>						
Leakage Current	$V_{PG} = 5\text{V}$			0.1	1	$\mu\text{A}$
Output Voltage Low	$I_{PG} = 40\mu\text{A}$	●		0.2	0.3	V
Threshold as % of $V_{FB1}$	Pin Voltage Falling Pin Voltage Rising		88 108	90 110	92 112	% %
PG Threshold Hysteresis	Measured at FB1 Pin			30		mV
<b>Switching Regulator</b>						
Switching Frequency	$R_T = 37.4\text{k}$	●	1.8	2.0	2.1	MHz
	$R_T = 102\text{k}$	●	0.8	0.94	1.1	MHz
	$R_T = 487\text{k}$	●	220	243	300	kHz
Minimum Switch Off-Time		●		120	190	ns
Switch Current Limit (Note 7)	5% Duty Cycle, $V_{IN} = 5\text{V}$ , $V_{FB1} = 0\text{V}$	●	600	750	950	mA
	90% Duty Cycle, $V_{IN} = 5\text{V}$ , $V_{FB1} = 0\text{V}$	●	450	550	800	mA
Switch $V_{CESAT}$	$I_{SW} = 200\text{mA}$			300		mV
DA Pin Current to Stop Switching		●	420	500	650	mA
Switch Leakage Current	$V_{SW} = 0\text{V}$			0.05	2	$\mu\text{A}$
Boost Schottky Diode Forward Voltage	$I_{BOOSTDIODE} = 50\text{mA}$ , $V_{IN} = \text{NC}$ , $V_{BOOST} = 0\text{V}$			900		mV
Boost Schottky Diode Reverse Leakage	$V_{REVERSE} = 12\text{V}$ , $V_{IN} = \text{NC}$			0.04	4	$\mu\text{A}$
Minimum Boost Voltage (Note 8)		●		1.7	2.5	V
BOOST Pin Current	$I_{SW} = 200\text{mA}$ , $V_{BOOST} = 15\text{V}$			10	16	mA
Feedback Voltage (FB1)		●	1.188 1.176	1.2 1.2	1.212 1.224	V mV
FB1 Pin Bias Current	Pin Voltage = 1.2V	●		0.1	20	nA
Reference Voltage Line Regulation	$4.2\text{V} < V_{IN1} < 40\text{V}$			0.001	0.005	%/V
<b>Each LDO Regulator</b>						
Minimum Input Voltage	$I_{LOAD} = 200\text{mA}$	●		1.6	2.2	V
Output Voltage Range		●	1.1		10	V
Tracking Error $V_{OUT2/3} - V_{ADJ2/3}$	$1.1\text{V} \leq V_{ADJ2/3} \leq 5\text{V}$ , $I_{LOAD} = 1\text{mA}$	●	-6		6	mV
	$5\text{V} < V_{ADJ2/3} \leq 10\text{V}$ , $I_{LOAD} = 1\text{mA}$	●	-20		50	mV

## ELECTRICAL CHARACTERISTICS

The ● denotes the specifications which apply over the full operating temperature range, otherwise specifications are at  $T_A = 25^\circ\text{C}$ .  $V_{IN1} = 12\text{V}$  unless otherwise noted. (Note 4)

PARAMETER	CONDITIONS	MIN	TYP	MAX	UNITS
Dropout Voltage (Notes 9, 10), $V_{IN} = V_{OUT(NOMINAL)}$	$I_{LOAD} = 1\text{mA}$ $I_{LOAD} = 1\text{mA}$ ●		70	165 210	mV mV
	$I_{LOAD} = 50\text{mA}$ $I_{LOAD} = 50\text{mA}$ ●		230	300 400	mV mV
	$I_{LOAD} = 100\text{mA}$ $I_{LOAD} = 100\text{mA}$ ●		280	400 450	mV mV
	$I_{LOAD} = 200\text{mA}$ $I_{LOAD} = 200\text{mA}$ ●		340	650 700	mV mV
GND Pin Current, $V_{IN} = V_{OUT(NOMINAL)} + 0.6\text{V}$ (Notes 10, 11)	$I_{LOAD} = 0\text{mA}$ ●		40	90	$\mu\text{A}$
	$I_{LOAD} = 50\text{mA}$ ●		1	2	$\text{mA}$
	$I_{LOAD} = 200\text{mA}$ ●		5	10	$\text{mA}$
Quiescent Current $I_{IN2}$ with LDO2 Disabled Quiescent Current $I_{IN3/BD}$ with LDO3 Disabled	$V_{IN1} = 0\text{V}$ , $V_{IN2} = 12\text{V}$ , $V_{EN2/ILIM2} = 2\text{V}$		13	20	$\mu\text{A}$
	$V_{IN1} = 16\text{V}$ , $V_{IN3/BD} = 12\text{V}$ , $V_{EN3/ILIM3} = 2\text{V}$		1.2	2	$\mu\text{A}$
ADJ2 Pin Bias Current (Note 10) ADJ3 Pin Bias Current (Note 10)	$V_{ADJ2} \leq 10\text{V}$ , $V_{ADJ2} \leq V_{IN2} - 0.6\text{V}$ , $V_{OUT2} \leq V_{IN2} - 0.6\text{V}$ ●			600	$\text{nA}$
	$V_{ADJ3} \leq 10\text{V}$ , $V_{ADJ3} \leq V_{IN3/BD} - 0.6\text{V}$ , $V_{OUT3} \leq V_{IN3/BD} - 0.6\text{V}$ ●			600	$\text{nA}$
Ripple Rejection	$V_{IN} - V_{OUT} = 2\text{V (AVG)}$ , $V_{RIPPLE} = 0.5\text{V}_{P-P}$ , $f_{RIPPLE} = 120\text{Hz}$ , $I_{LOAD} = 200\text{mA}$	60	85		$\text{dB}$
Reverse Output Current (Note 12)	$V_{OUT2} = 1.2\text{V}$ , $V_{IN1} = V_{IN2} = V_{IN3/BD} = 0\text{V}$		5	40	$\mu\text{A}$
	$V_{OUT3} = 1.2\text{V}$ , $V_{IN1} = V_{IN2} = V_{IN3/BD} = 0\text{V}$		5	40	$\mu\text{A}$
Input Reverse Leakage Current LDO2	$V_{IN2} = -45\text{V}$ , $V_{IN1} = V_{IN3/BD} = V_{OUT2} = 0\text{V}$ ●			300	$\mu\text{A}$
Internal Current Limit	$V_{IN2} = 2.2\text{V}$ , $V_{OUT2} = 0\text{V}$ , EN2/ILIM2 Pin Grounded		300		$\text{mA}$
	$\Delta V_{OUT2} = -5\%$ ●	220			$\text{mA}$
	$V_{IN3/BD} = 2.2\text{V}$ , $V_{OUT3} = 0\text{V}$ , EN3/ILIM3 Pin Grounded		300		$\text{mA}$
	$\Delta V_{OUT3} = -5\%$ ●	220			$\text{mA}$
Externally Programmed Current Limit	$R_{EN/ILIM} = 31.6\text{k}$ , $V_{OUT2/3} = 5\text{V}$ , $V_{IN2/3} \geq 5.6\text{V}$ ●	9.5	10	10.5	$\text{mA}$
	$R_{EN/ILIM} = 6.19\text{k}$ , $V_{OUT2/3} = 5\text{V}$ , $V_{IN2/3} \geq 5.6\text{V}$ ●	47	51	55	$\text{mA}$
	$R_{EN/ILIM} = 6.19\text{k}$ , $V_{OUT2/3} = 5\text{V}$ , $5.6\text{V} \leq V_{IN2/3} \leq 15\text{V}$ ●	48.45	51	53.55	$\text{mA}$
	$R_{EN/ILIM} = 1.54\text{k}$ , $V_{OUT2/3} = 5\text{V}$ , $5.6\text{V} \leq V_{IN2/3} \leq 15\text{V}$ ●	176	197	230	$\text{mA}$
LDO EN/ILIM Disable Threshold		0.3		1.2	V

**Note 1:** Stresses beyond those listed under Absolute Maximum Ratings may cause permanent damage to the device. Exposure to any Absolute Maximum Rating condition for extended periods may affect device reliability and lifetime.

**Note 2:** Positive currents flow into pins, negative currents flow out of pins. Minimum and maximum values refer to absolute values.

**Note 3:** Absolute maximum voltage at the IN1 and EN pins is 60V for nonrepetitive 1 second transients, and 40V for continuous operation.

**Note 4:** The LT3668E is guaranteed to meet performance specifications from  $0^\circ\text{C}$  to  $125^\circ\text{C}$  junction temperature. Specifications over the  $-40^\circ\text{C}$  to  $125^\circ\text{C}$  operating junction temperature range are assured by design, characterization and correlation with statistical process controls. The LT3668I is guaranteed over the full  $-40^\circ\text{C}$  to  $125^\circ\text{C}$  operating junction temperature range.

**Note 5:** This IC includes overtemperature protection that is intended to protect the device during momentary overload conditions. Junction temperature will exceed the maximum operating junction temperature when overtemperature protection is active. Continuous operation above the specified maximum operating junction temperature may impair device reliability.

**Note 6:** This is the voltage necessary to keep the internal bias circuitry in regulation.

**Note 7:** Current limit guaranteed by design and/or correlation to static test. Slope compensation reduces current limit at higher duty cycles.

**Note 8:** This is the minimum voltage across the boost capacitor needed to guarantee full saturation of the switch.

**Note 9:** Dropout voltage is the minimum input-to-output voltage differential needed for an LDO to maintain regulation at a specified output current. When an LDO is in dropout, its output voltage will be equal to  $V_{IN} - V_{DROD}$ .

**Note 10:** The LT3668 is tested and specified for these conditions with  $V_{ADJ2/3} = 5\text{V}$ .

**Note 11:** GND pin current is tested with  $V_{IN} = V_{OUT(NOMINAL)} + 0.6\text{V}$  and a current source load. GND pin current increases in dropout.

**Note 12:** Reverse output current is tested with the IN2 (IN3/BD) pin grounded and the OUT2 (OUT3) pin forced to the rated output voltage. This current flows into the OUT2 (OUT3) pin and out of the GND pin.

**TYPICAL PERFORMANCE CHARACTERISTICS**  $T_A = 25^\circ\text{C}$ , unless otherwise noted.

**Efficiency,  $V_{OUT1} = 3.3\text{V}$**

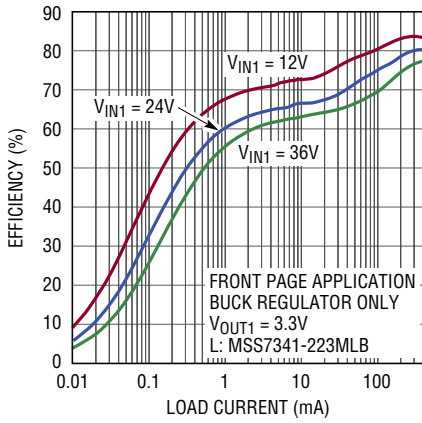

3668 G01

**Efficiency,  $V_{OUT1} = 6\text{V}$**

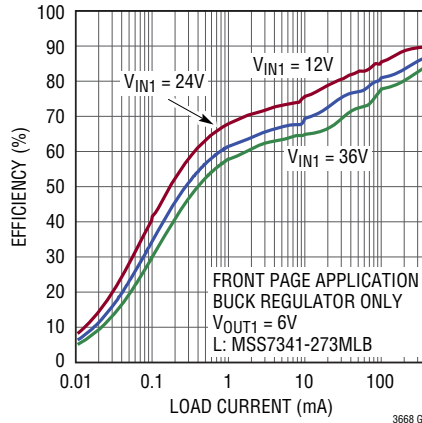

3668 G02

**$V_{FB1}$  vs Temperature**

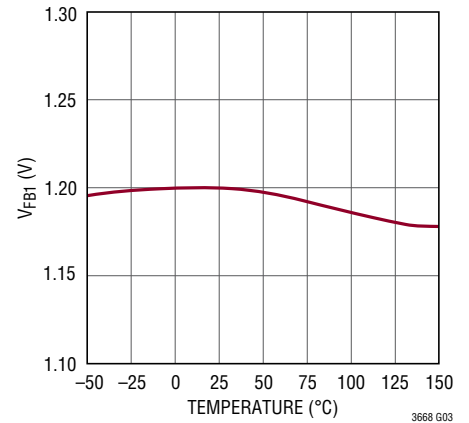

3668 G03

**No-Load Supply Current**

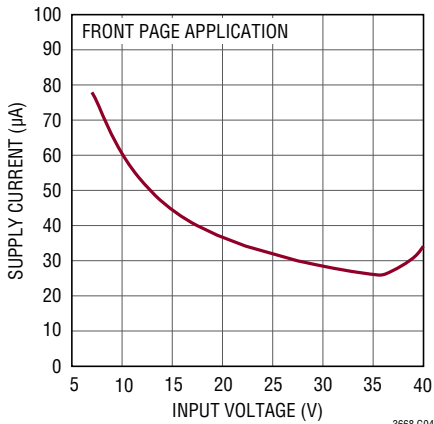

3668 G04

**No-Load Supply Current**

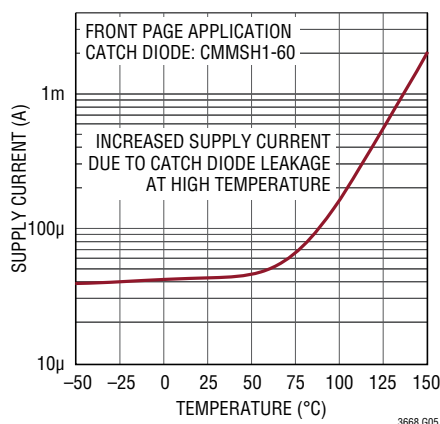

3668 G05

**Maximum Load Current**

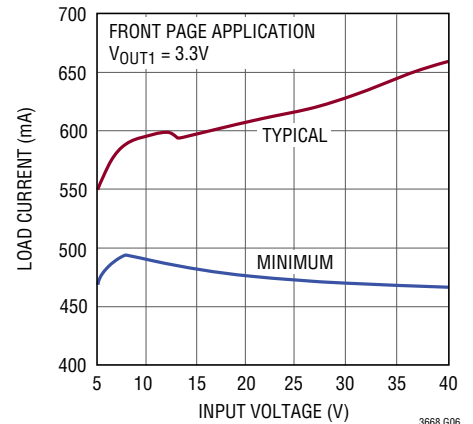

3668 G06

**Maximum Load Current**

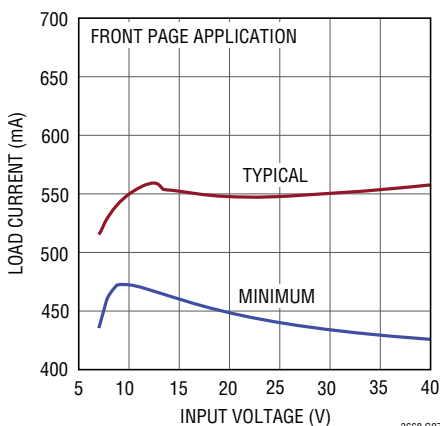

3668 G07

**Switching Regulator Load Regulation**

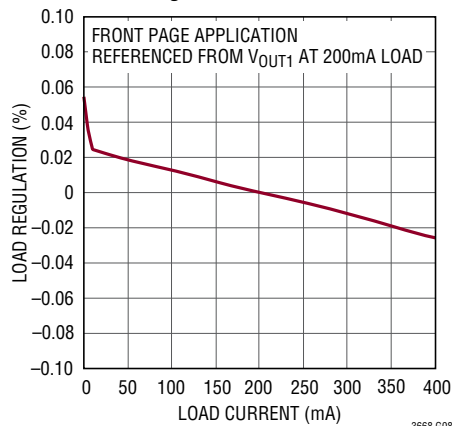

3668 G08

**Switch Current Limit**

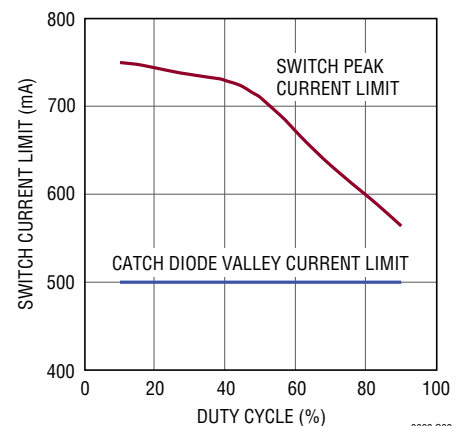

3668 G09

## TYPICAL PERFORMANCE CHARACTERISTICS $T_A = 25^\circ\text{C}$ , unless otherwise noted.

### Switch Current Limit

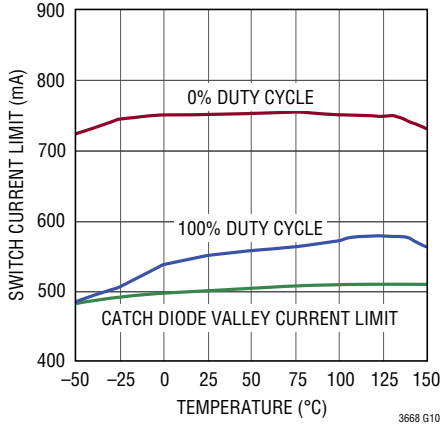

### Switching Frequency

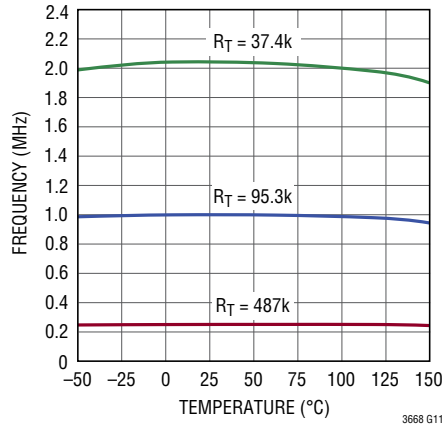

### Minimum Switch On-Time/ Switch-Off Time

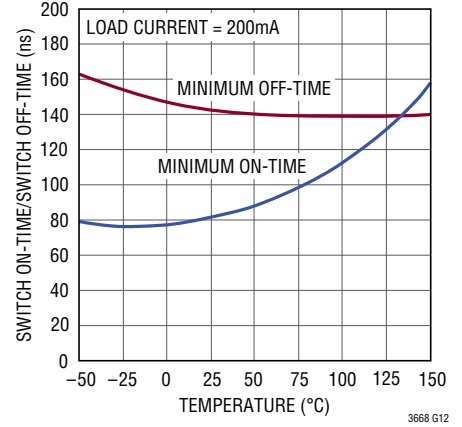

### Switch $V_{CESAT}$

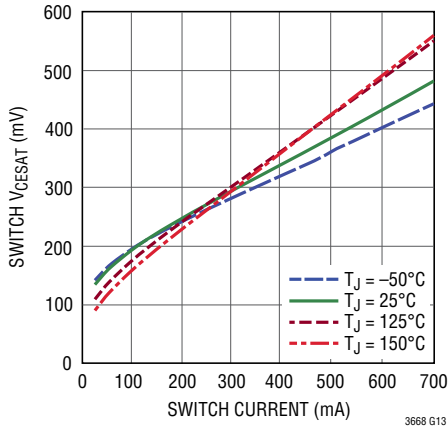

### BOOST Pin Current

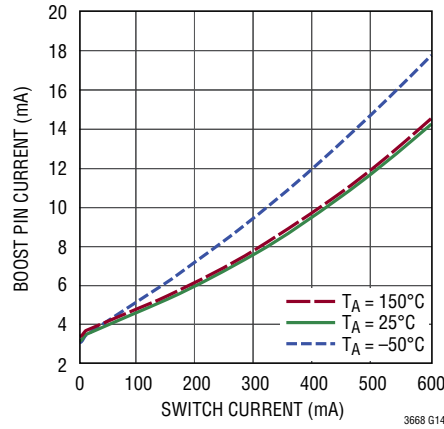

### Minimum Input Voltage, $V_{OUT1} = 3.3\text{V}$

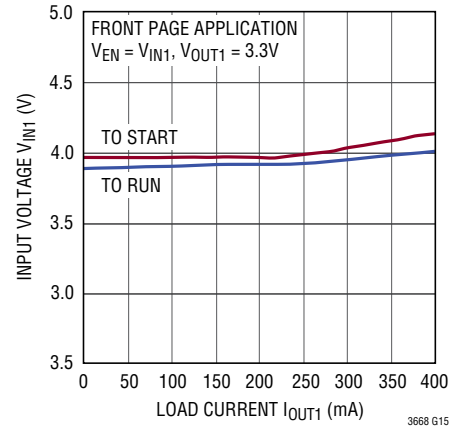

### Minimum Input Voltage, $V_{OUT1} = 6\text{V}$

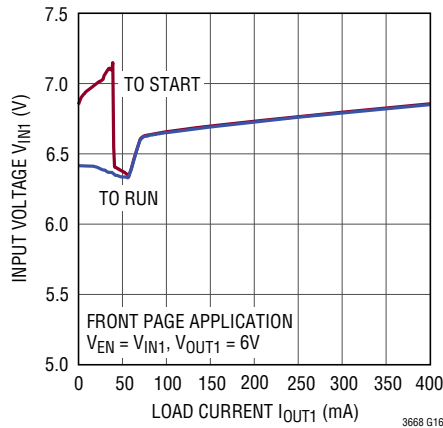

### Transient Load Response, Load Step 10mA to 140mA

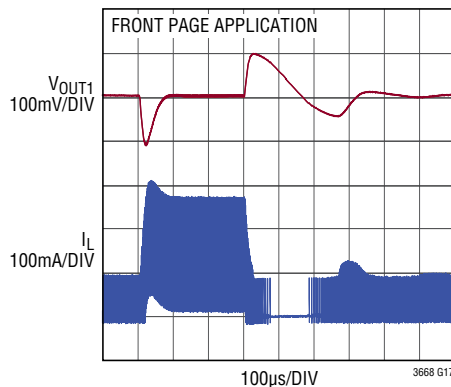

### Transient Load Response Load Step 150mA to 300mA

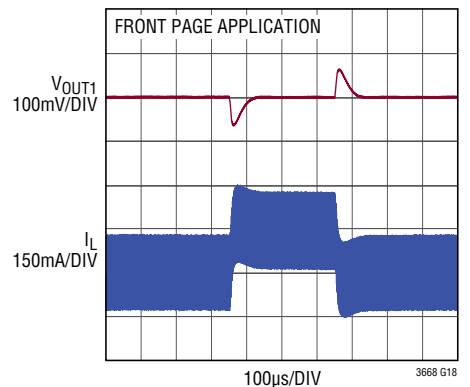

**TYPICAL PERFORMANCE CHARACTERISTICS**  $T_A = 25^\circ\text{C}$ , unless otherwise noted.

**Switching Waveforms, Burst Mode Operation**

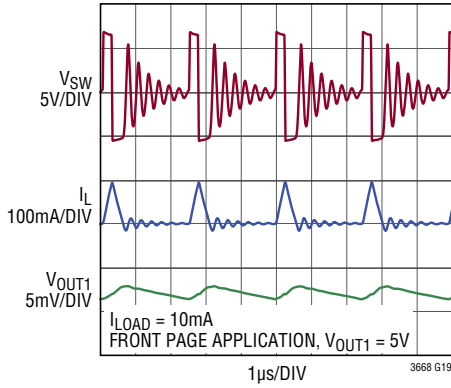

**Switching Waveforms, Full Frequency Continuous Operation**

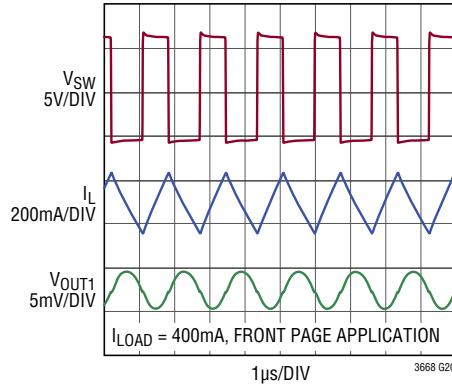

**EN Threshold**

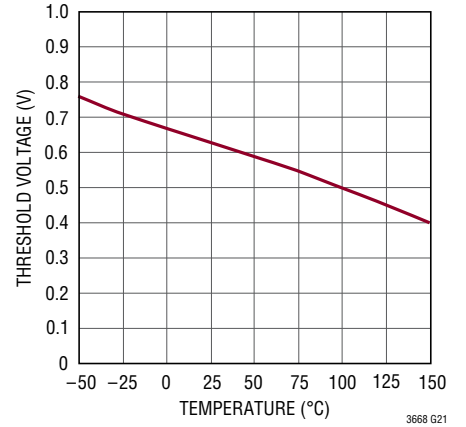

**EN Pin Current**

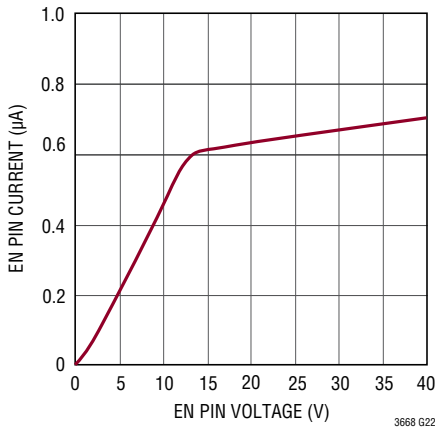

**LDOs: Tracking**

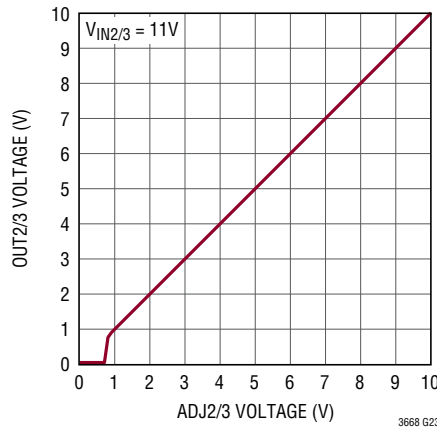

**LDOs: Tracking Error**

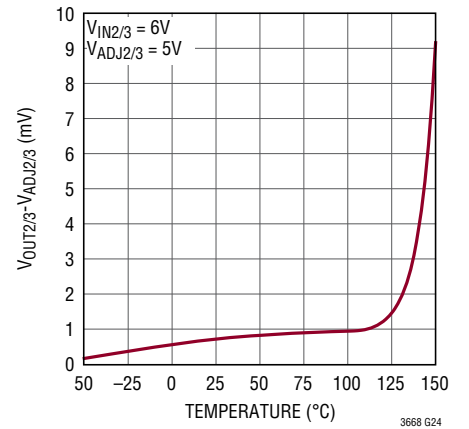

**LDOs: Tracking Error**

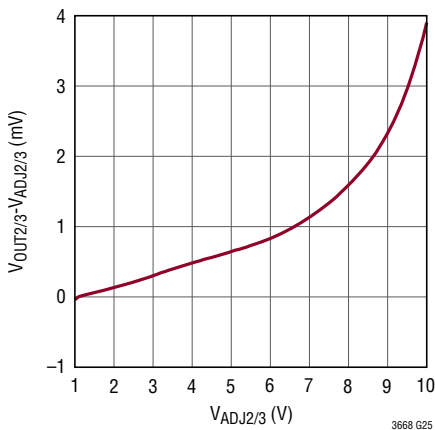

**LDOs: Typical Dropout Voltage**

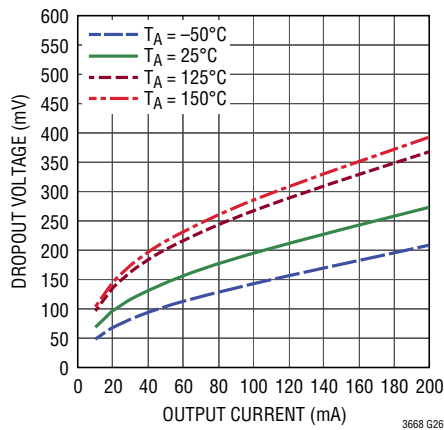

**LDOs: Guaranteed Dropout Voltage**

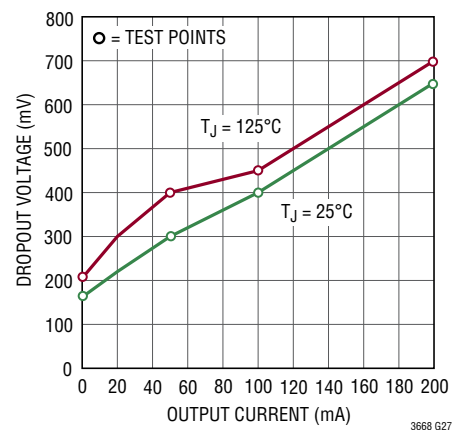

**TYPICAL PERFORMANCE CHARACTERISTICS**  $T_A = 25^\circ\text{C}$ , unless otherwise noted.

**LDOs:  
IN2, IN3 Quiescent Current**

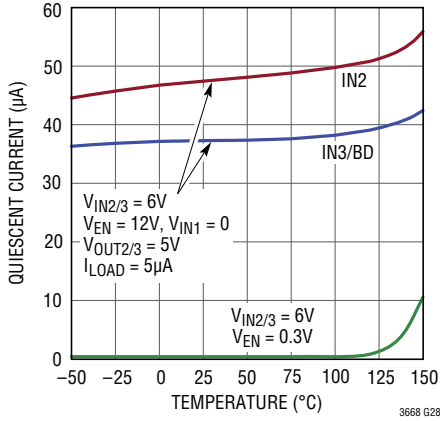

**LDOs:  
5V Quiescent Current IN2**

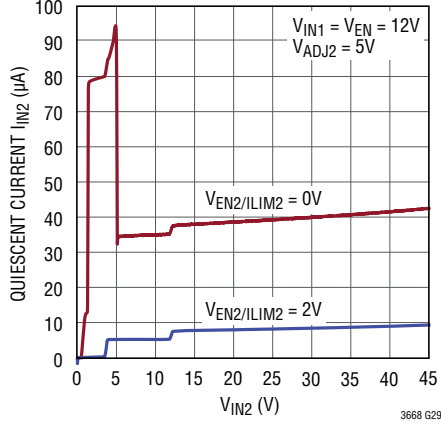

**LDOs:  
5V Quiescent Current IN3/BD**

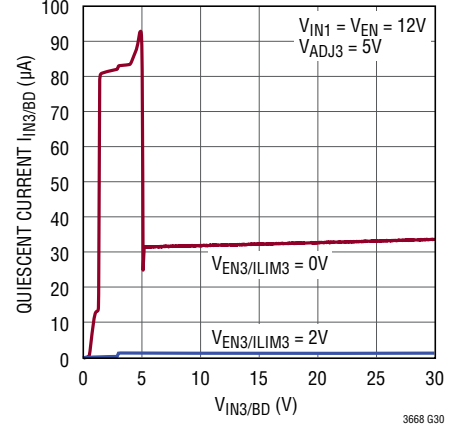

**ADJ2, ADJ3 Pin Bias Current**

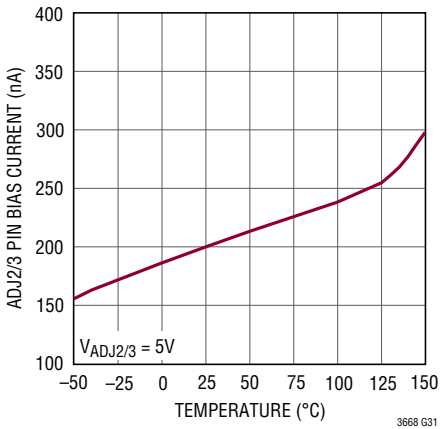

**LDOs:  
Internal Current Limit**

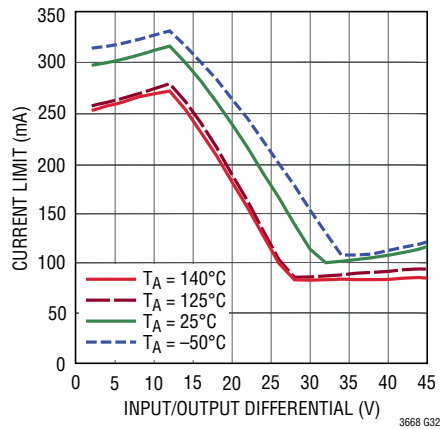

**LDOs:  
Internal Current Limit**

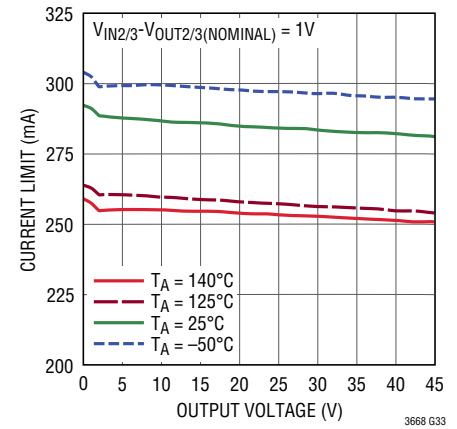

**LDOs:  
Reverse Output Current**

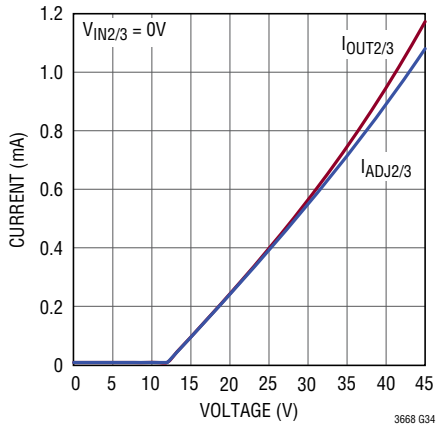

**LDOs:  
Reverse Output Current**

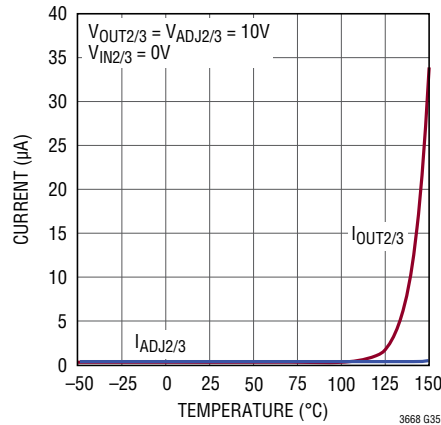

**LDOs:  
Input Ripple Rejection**

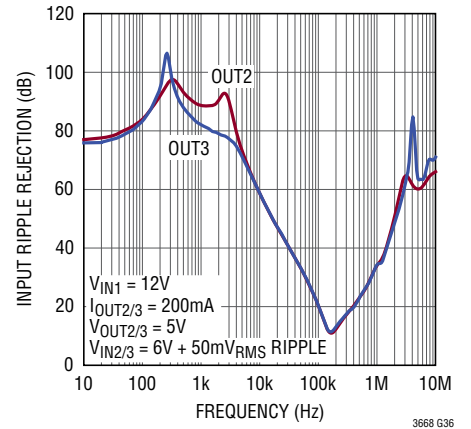



**TYPICAL PERFORMANCE CHARACTERISTICS**  $T_A = 25^\circ\text{C}$ , unless otherwise noted.

**LDOs:**  
Minimum Input Voltage

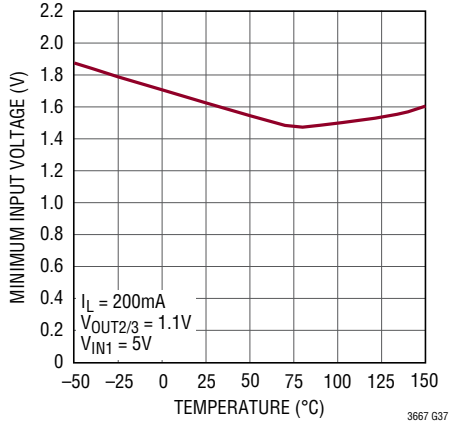

**LDOs:**  
Load Regulation

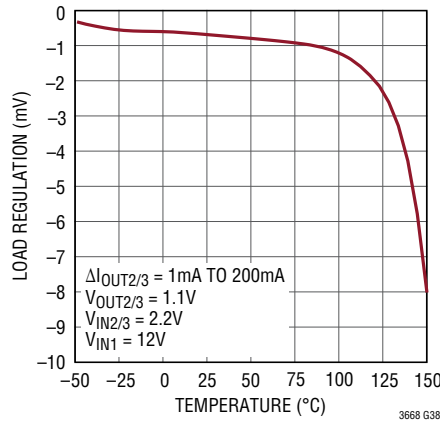

**LDOs:**  
Output Noise Spectral Density

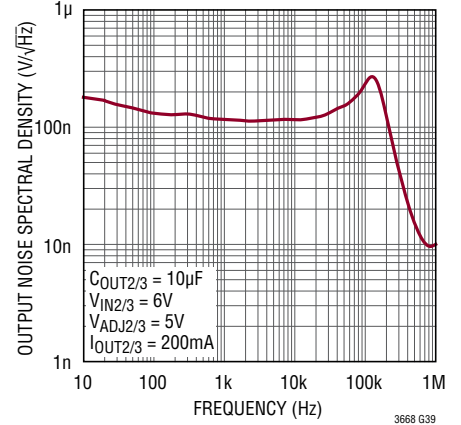

**LDOs:**  
RMS Output Noise

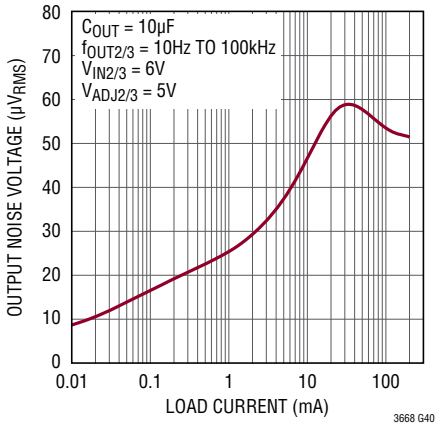

**LDOs:**  
Small Signal Transfer Function

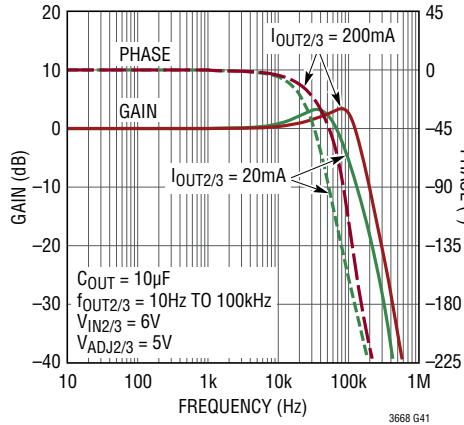

**LDOs:**  
Transient Response

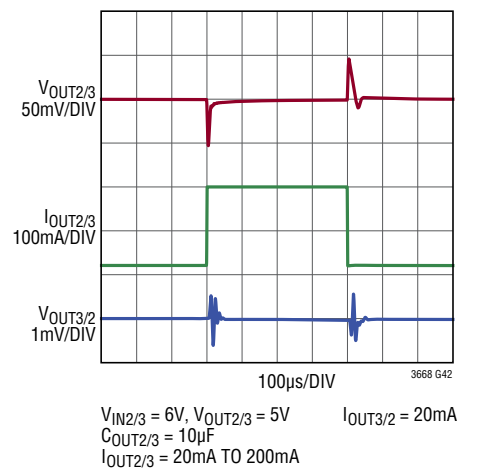

**LDOs: External Current Limit,**  
 $R_{EN}/I_{LIM} = 1.54k$

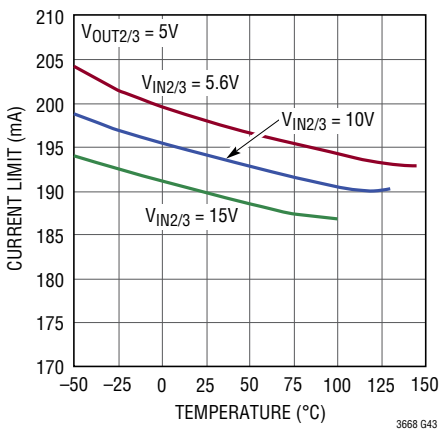

**LDOs: External Current Limit,**  
 $R_{EN}/I_{LIM} = 6.19k$

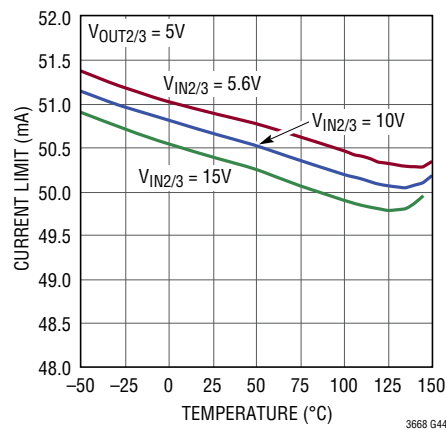

**LDOs: External Current Limit,**  
 $R_{EN}/I_{LIM} = 31.6k$

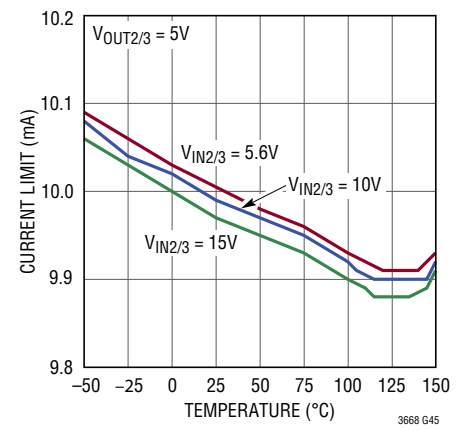

## PIN FUNCTIONS

**SW (Pin 1):** The SW pin is the output of the internal power switch. Connect this pin to the inductor, the catch diode and the boost capacitor.

**BOOST (Pin 2):** This pin is used to provide a drive voltage, higher than the input voltage, to the internal bipolar NPN power switch of the switching regulator. Connect a capacitor (typically 0.22 $\mu$ F) between BOOST and SW.

**EN (Pin 3):** The EN pin is used to put the LT3668 in shut-down mode. Tie to ground to shut down the LT3668. Tie to 1V or more for normal operation. If the EN pin is to be pulled below ground, use a series resistor to limit the pin current to 1mA.

**RT (Pin 4):** Oscillator Resistor Input. Connect a resistor from this pin to ground to set the switching frequency.

**OUT3 (Pin 6), OUT2 (Pin 10):** These are the outputs of the two LDOs. Stability requirements demand a minimum 10 $\mu$ F ceramic output capacitor to prevent oscillations.

**ADJ3 (Pin 9), ADJ2 (Pin 7):** The two LDOs of the LT3668 regulate their outputs to follow the voltages at the ADJ2 and ADJ3 pins. Connect the reference voltage to these pins.

**FB1 (Pin 8):** The switching regulator of the LT3668 regulates the FB1 pin to 1.2V. Connect the feedback resistor divider tap to this pin.

**IN2 (Pin 11), IN3/BD (Pin 5):** These pins are the inputs of the two LDOs. IN3/BD also connects to the anode of the internal boost diode and also supplies current to the LT3668's internal regulator when IN3/BD is above 3.2V.

**EN2/ILIM2 (Pin 12), EN3/ILIM3 (Pin 13):** Precision current limit programming pins. They connect to collectors of current mirror PNPs which are 1/799th the size of the output power PNPs of the two LDOs. These pins are also the inputs to the current limit amplifiers. Current limit thresholds are set by connecting resistors between the EN2/ILIM2 pin and GND and between the EN3/ILIM3 pin and GND. Stability requirements demand 47nF capacitors in parallel to these resistors. For detailed information on how to set the pin resistor values, see the Operation section. If any of these pins is not used, tie it to GND. To disable an LDO, pull its EN/ILIM pin above 1.2V. If an EN/ILIM pin is used as a digital input for enable/disable, ensure rise and fall times of less than 1 $\mu$ s.

**PG (Pin 14):** The PG pin is the open-drain output of an internal window comparator. PG remains low until the FB1 pin is within  $\pm 10\%$  of its final regulation voltage. PG output is valid when  $V_{IN1}$  or  $V_{IN2}$  are above the minimum input voltage and EN is high.

**IN1 (Pin 15):** The IN1 pin supplies current to the internal regulator and to the internal power switch. This pin must be locally bypassed.

**DA (Pin 16):** Connect the anode of the catch diode (D1 in Block Diagram) to this pin. Internal circuitry senses the current through the catch diode providing frequency foldback in overload conditions.

**GND (Exposed Pad Pin 17):** This is the ground of all internal circuitry, as well as the power ground used by the catch diode (D1). The exposed pad must be soldered to the PCB.

**BLOCK DIAGRAM**

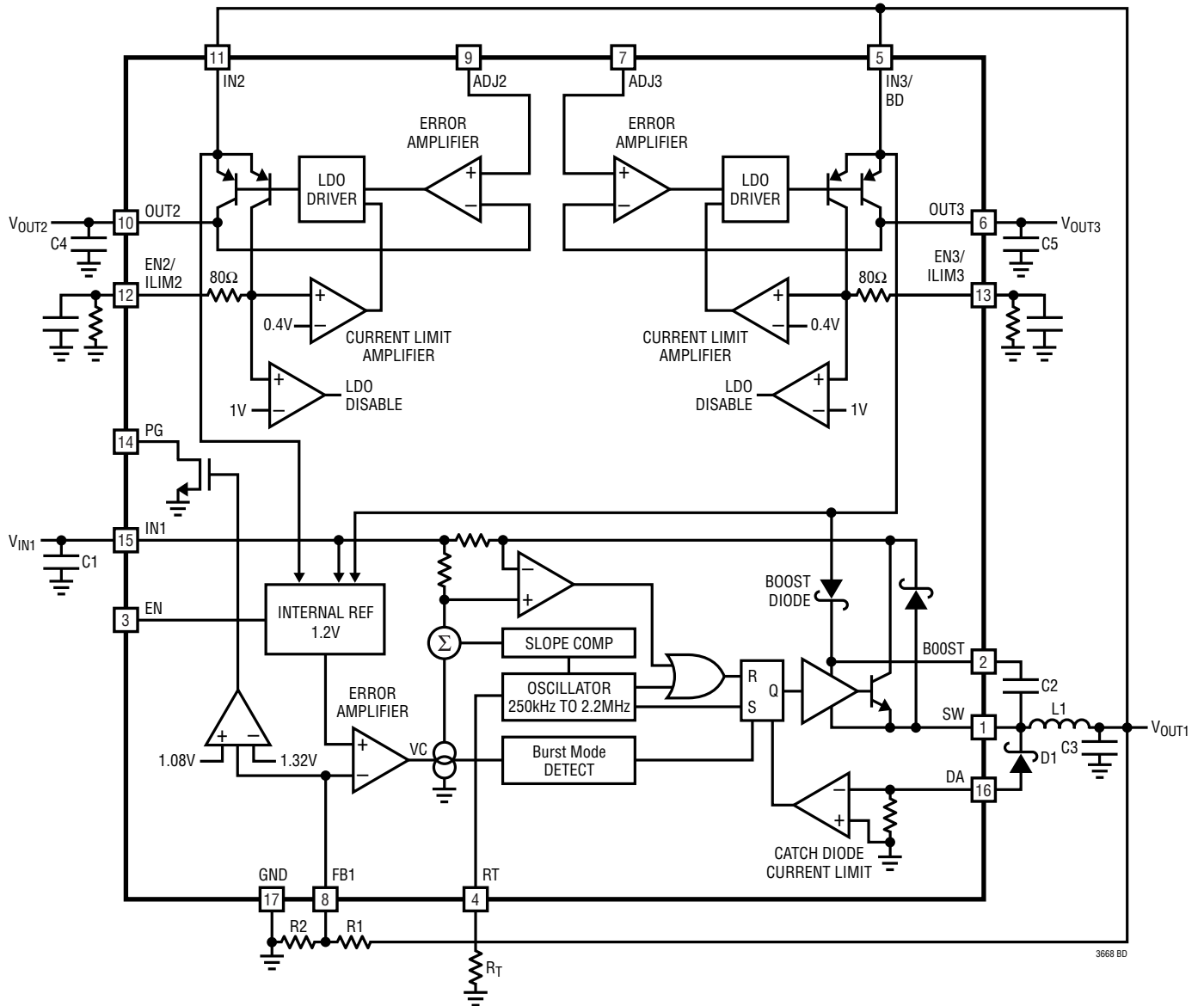

3668 BD

## OPERATION

The LT3668 combines a 400mA buck switching regulator and two 200mA low dropout linear tracking regulators. Operation is best understood by referring to the Block Diagram.

The buck regulator part is a constant frequency, current mode step-down regulator. An oscillator, with frequency set by  $R_T$ , sets an RS flip-flop, turning on the internal power switch. An amplifier and comparator monitor the current flowing between the IN1 and SW pins, turning the switch off when this current reaches a level determined by the voltage at VC. An error amplifier measures the output voltage through an external resistor divider tied to the FB1 pin and servos the VC node. If the error amplifier's output increases, more current is delivered to the output; if it decreases, less current is delivered.

Another comparator monitors the current flowing through the catch diode and reduces the operating frequency when the current exceeds the 500mA bottom current limit. This foldback in frequency helps to control the output current in fault conditions such as a shorted output with high input voltage. Maximum deliverable current to the output is therefore limited by both switch current limit and catch diode current limit.

An internal regulator provides power to the control circuitry. The bias regulator normally draws power from the IN1 pin, but if the IN3/BD pin is connected to an external voltage higher than 3.2V, bias power will be drawn from the external source (typically the regulated output voltage). This improves efficiency.

The switch driver operates from either IN1 or from the BOOST pin. An external capacitor is used to generate a voltage at the BOOST pin that is higher than the input supply. This allows the driver to fully saturate the internal NPN power switch for efficient operation.

To further optimize efficiency, the LT3668 automatically switches to Burst Mode operation in light load situations. Between bursts, all circuitry associated with control-

ling the output switch is shut down, reducing the input supply current to 50 $\mu$ A (including the current drawn by the LDOs).

The switching regulator has an overvoltage protection feature which disables switching action when IN1 goes above 42V (typical) during transients. It can then safely sustain transient input voltages up to 60V.

The LDO blocks are micropower, low noise 200mA linear tracking regulators with low dropout voltage and current limit, which provide fast transient response with minimum low ESR 10 $\mu$ F ceramic output capacitors. The output voltage of each LDO follows a reference voltage applied to its adjust input with high accuracy. Each output current limit can be programmed individually with a single resistor, and pulling the EN2/ILIM2 or EN3/ILIM3 pin high shuts down the corresponding LDO. Internal protection circuitry includes reverse-battery protection, reverse output protection, reverse-current protection and current limit with foldback.

The internal reference voltage circuitry is supplied by the IN1 and IN2 pins. This allows the LDO at IN2 to run independently and supply the switching regulator with its output OUT2.

The EN pin is used to place the LT3668 in shutdown, thereby reducing the input current to less than 1 $\mu$ A.

The LT3668 contains a power good window comparator that indicates whether the output voltage of the switching regulator is within  $\pm 10\%$  of its nominal value. The output PG of this comparator is an open-drain transistor which is off when the output is in regulation, allowing external resistors to pull the PG pin high. Power good is valid if the LT3668 is enabled and IN1 or IN2 are above their minimum input voltages.

Internal thermal limiting protects the LT3668 during overload conditions.

## APPLICATIONS INFORMATION

### SWITCHING REGULATOR

#### FB1 Resistor Network

The switching regulator output voltage of the LT3668 is programmed with a resistor divider between the output of the switching regulator and the FB1 pin. Choose the resistor values according to:

$$R1 = R2 \left( \frac{V_{OUT1}}{1.2V} - 1 \right)$$

Reference designators refer to the Block Diagram of the LT3668. 1% resistors are recommended to maintain output voltage accuracy. Note that choosing larger resistors will decrease the quiescent current of the application circuit.

#### Setting the Switching Frequency

The LT3668 regulators use a constant frequency PWM architecture that can be programmed to switch from 250kHz to 2.2MHz by using a resistor tied from the RT pin to ground. Table 1 shows the necessary  $R_T$  value for a desired switching frequency.

**Table 1: Switching Frequency vs  $R_T$  Value**

SWITCHING FREQUENCY (MHz)	$R_T$ VALUE (k $\Omega$ )
0.25	475
0.3	383
0.4	274
0.5	215
0.6	174
0.8	124
1	95.3
1.2	75
1.4	61.9
1.6	51.1
1.8	43.2
2	37.4
2.2	32.4

#### Operating Frequency Trade-Offs

Selection of the operating frequency is a trade-off between efficiency, component size, minimum dropout voltage, and maximum input voltage. The advantage of high frequency operation is that smaller inductor and capacitor values may be used. The disadvantages are lower efficiency, lower maximum input voltage, and higher dropout voltage. The highest acceptable switching frequency ( $f_{SW(MAX)}$ ) for a given application can be calculated as follows:

$$f_{SW(MAX)} = \frac{V_{OUT1} + V_D}{t_{ON(MIN)} (V_{IN1} - V_{SW} + V_D)}$$

where  $V_{IN1}$  is the typical input voltage,  $V_{OUT1}$  is the output voltage,  $V_D$  is the catch diode drop ( $\sim 0.5V$ ) and  $V_{SW}$  is the internal switch drop ( $\sim 0.5V$  at max load). This equation shows that slower switching frequency is necessary to accommodate high  $V_{IN1}/V_{OUT1}$  ratio.

Lower frequency also allows a lower dropout voltage. Input voltage range depends on the switching frequency because the LT3668 switch has finite minimum on and off times. The switch can turn on for a minimum of  $\sim 150ns$  and turn off for a minimum of  $\sim 190ns$  (note that the minimum on-time is a strong function of temperature). The minimum and maximum duty cycles that can be achieved taking minimum on and off times into account are:

$$DC_{MIN} = f_{SW} \cdot t_{ON(MIN)}$$

$$DC_{MAX} = 1 - f_{SW} \cdot t_{OFF(MIN)}$$

where  $f_{SW}$  is the switching frequency,  $t_{ON(MIN)}$  is the minimum switch on-time ( $\sim 150ns$ ), and  $t_{OFF(MIN)}$  is the minimum switch off-time ( $\sim 190ns$ ). These equations show that the duty cycle range increases when the switching frequency is decreased.

A good choice of switching frequency should allow an adequate input voltage range (see Input Voltage Range section) and keep the inductor and capacitor values small.

## APPLICATIONS INFORMATION

### Input Voltage Range

The minimum input voltage is determined by either the LT3668's minimum operating voltage of 4.3V or by its maximum duty cycle (as discussed in the previous section). The minimum input voltage due to duty cycle is:

$$V_{IN1(MIN)} = \frac{V_{OUT1} + V_D}{1 - f_{SW} \cdot t_{OFF(MIN)}} - V_D + V_{SW}$$

where  $V_{IN1(MIN)}$  is the minimum input voltage,  $V_{OUT1}$  is the output voltage,  $V_D$  is the catch diode drop (~0.5V),  $V_{SW}$  is the internal switch drop (~0.5V at maximum load),  $f_{SW}$  is the switching frequency, and  $t_{OFF(MIN)}$  is the minimum switch off-time (~190ns). Note that a higher switching frequency will increase the minimum input voltage. If a lower dropout voltage is desired, a lower switching frequency should be used.

The highest allowed  $V_{IN1}$  during normal operation ( $V_{IN1(OP-MAX)}$ ) is limited by minimum duty cycle and is given by:

$$V_{IN1(OP-MAX)} = \frac{V_{OUT1} + V_D}{f_{SW} \cdot t_{ON(MIN)}} - V_D + V_{SW}$$

where  $V_{OUT1}$  is the output voltage,  $V_D$  is the catch diode drop (~0.5V),  $V_{SW}$  is the internal switch drop (~0.5V at maximum load),  $f_{SW}$  is the switching frequency, and  $t_{ON(MIN)}$  is the minimum switch on-time (~150ns).

However, the LT3668 will tolerate inputs up to the absolute maximum ratings of the  $V_{IN1}$  and BOOST pins, regardless of the chosen switching frequency. During such transients where  $V_{IN1}$  is higher than  $V_{IN1(OP-MAX)}$ , the part will skip pulses to maintain output regulation. The output voltage ripple and inductor current ripple will be higher than in normal operation. Input voltage transients of up to 60V are also safely withstood, though the LT3668 stops switching while  $V_{IN1} > V_{OVLO}$  (overvoltage lockout, 42V typical), allowing the output to fall out of regulation.

During start-up, short-circuit, or other overload conditions the inductor peak current might reach and even exceed the maximum current limit of the LT3668, especially in those cases where the switch already operates at minimum on-time. The catch diode current limit circuitry prevents the switch from turning on again if the inductor valley current is above 500mA nominal.

### Inductor Selection and Maximum Output Current

For a given input and output voltage, the inductor value and switching frequency will determine the ripple current, which increases with higher  $V_{IN1}$  or  $V_{OUT1}$  and decreases with higher inductance and higher switching frequency.

A good first choice for the inductor value is:

$$L = (V_{OUT1} + V_D) \cdot \frac{2.4}{f_{SW}}$$

where  $f_{SW}$  is the switching frequency in MHz,  $V_{OUT1}$  is the output voltage,  $V_D$  is the catch diode drop (~0.5V) and  $L$  is the inductor value in  $\mu$ H. The inductor's RMS current rating must be greater than the maximum load current and its saturation current should be about 30% higher. For robust operation in fault conditions (start-up or short-circuit) and high input voltage (>30V), the saturation current should be above 900mA. To keep the efficiency high, the series resistance (DCR) should be less than 0.3 $\Omega$ , and the core material should be intended for high frequency applications. Table 2 lists several vendors.

**Table 2. Inductor Vendors**

VENDOR	URL
Coilcraft	<a href="http://www.coilcraft.com">www.coilcraft.com</a>
Sumida	<a href="http://www.sumida.com">www.sumida.com</a>
Toko	<a href="http://www.tokoam.com">www.tokoam.com</a>
Würth Elektronik	<a href="http://www.we-online.com">www.we-online.com</a>
Coiltronics	<a href="http://www.cooperet.com">www.cooperet.com</a>
Murata	<a href="http://www.murata.com">www.murata.com</a>



## APPLICATIONS INFORMATION

This simple design guide will not always result in the optimum inductor selection for a given application. As a general rule, lower output voltages and higher switching frequency will require smaller inductor values. If the application requires less than 400mA load current, then a lesser inductor value may be acceptable. This allows the use of a physically smaller inductor, or one with a lower DCR resulting in higher efficiency. However, the inductance should in general not be smaller than 10 $\mu$ H.

Be aware that if the inductance differs from the simple rule above, then the maximum load current will depend on input voltage. In addition, low inductance may result in discontinuous mode operation, which further reduces maximum load current. For details of maximum output current and discontinuous mode operation, see Linear Technology's Application Note 44. Finally, for duty cycles greater than 50% ( $V_{OUT1}/V_{IN1} > 0.5$ ), a minimum inductance is required to avoid sub-harmonic oscillations:

$$L_{MIN} = (V_{OUT1} + V_D) \cdot \frac{2}{f_{SW}}$$

where  $f_{SW}$  is the switching frequency in MHz,  $V_{OUT1}$  is the output voltage,  $V_D$  is the catch diode drop (~0.5V) and  $L_{MIN}$  is the inductor value in  $\mu$ H.

### Catch Diode

The catch diode (D1 from block diagram) conducts current only during switch off-time. Use a 1A Schottky diode for best performance.

Peak reverse voltage is equal to  $V_{IN1}$  if it is below the overvoltage protection threshold. This feature keeps the switch off for  $V_{IN1} > OVLO$  (44V maximum). For inputs up to the maximum operating voltage of 40V, use a diode with a reverse voltage rating greater than the input voltage. If transients at the input of up to 60V are expected, use a diode with a reverse voltage rating only higher than the maximum OVLO of 44V. If operating at high ambient temperatures, consider using a Schottky with low reverse leakage. For example, Diodes Inc. SBR1U40LP or DFSL160, ON Semi MBRM140, and Central Semiconductor CMMSH1-60 are good choices for the catch diode.

### Input Capacitor

Bypass the input of the LT3668 circuit with a ceramic capacitor of X7R or X5R type. Y5V types have poor performance over temperature and applied voltage, and should not be used. A 1 $\mu$ F to 4.7 $\mu$ F ceramic capacitor is adequate to bypass the LT3668 and will easily handle the ripple current. Note that a larger input capacitance is required when a lower switching frequency is used (due to longer on-times). If the input power source has high impedance, or there is significant inductance due to long wires or cables, additional bulk capacitance may be necessary. This can be provided with a low performance electrolytic capacitor. Step-down regulators draw current from the input supply in pulses with very fast rise and fall times. The input capacitor is required to reduce the resulting voltage ripple at the LT3668 and to force this very high frequency switching current into a tight local loop, minimizing EMI. A 1 $\mu$ F capacitor is capable of this task, but only if it is placed close to the LT3668 (see the PCB Layout section). A second precaution regarding the ceramic input capacitor concerns the maximum input voltage rating of the LT3668. A ceramic input capacitor combined with trace or cable inductance forms a high quality (under damped) tank circuit. If the LT3668 circuit is plugged into a live supply, the input voltage can ring to twice its nominal value, possibly exceeding the LT3668's voltage rating. This situation is easily avoided (see the Hot Plugging Safely section).

### Output Capacitor and Output Ripple

The output capacitor has two essential functions. Along with the inductor, it filters the square wave generated by the LT3668 to produce the DC output. In this role it determines the output ripple, and low impedance at the switching frequency is important. The second function is to store energy in order to satisfy transient loads and stabilize the switching regulator's control loop. Ceramic capacitors have very low equivalent series resistance (ESR) and provide the best ripple performance. A good starting value is:

$$C_{OUT1} = \frac{50}{V_{OUT1} \cdot f_{SW}}$$

## APPLICATIONS INFORMATION

where  $f_{SW}$  is in MHz, and  $C_{OUT1}$  is the recommended output capacitance in  $\mu F$ . Use X5R or X7R types. This choice will provide low output ripple and good transient response. Transient performance can be improved with a higher value capacitor if combined with a phase lead capacitor (typically 22pF) between the output and pin FB1. Note that a larger phase lead capacitor should be used with a large output capacitor. A lower value of output capacitor can be used to save space and cost but transient performance will suffer.

When choosing a capacitor, look carefully through the data sheet to find out what the actual capacitance is under operating conditions (applied voltage and temperature). A physically larger capacitor, or one with a higher voltage rating, may be required. Table 3 lists several capacitor vendors.

**Table 3: Capacitor Vendors**

VENDOR	URL
Panasonic	www.panasonic.com
Kemet	www.kemet.com
Sanyo	www.sanyovideo.com
Murata	www.murata.com
AVX	www.avxcorp.com
Taiyo Yuden	www.taiyo-yuden.com

### Audible Noise

Ceramic capacitors are small, robust and have very low ESR. However, ceramic capacitors can sometimes cause problems when used with the LT3668 due to their piezoelectric nature. When in Burst Mode operation, the LT3668's switching frequency depends on the load current, and at very light loads the LT3668 can excite the ceramic capacitor at audio frequencies, generating audible noise. Since the LT3668 operates at a lower current limit during Burst Mode operation, the noise is typically very quiet. If this is unacceptable, use a high performance tantalum or electrolytic capacitor at the output.

### Low Ripple Burst Mode Operation

To enhance efficiency at light loads, the LT3668 operates in low ripple Burst Mode operation which keeps the output capacitor charged to the proper voltage while minimizing the input quiescent current. During Burst Mode operation, the LT3668 delivers single cycle bursts of current to the output capacitor followed by sleep periods where the output power is delivered to the load by the output capacitor. Because the LT3668 delivers power to the output with single, low current pulses, the output ripple is kept below 5mV for a typical application. As the load current decreases towards a no load condition, the percentage of time that the LT3668 operates in sleep mode increases and the average input current is greatly reduced resulting in high efficiency even at very low loads. Note that during Burst Mode operation, the switching frequency will be lower than the programmed switching frequency.

At higher output loads (above ~50mA for the front page application) the LT3668 will be running at the frequency programmed by the  $R_T$  resistor, and will be operating in standard PWM mode. The transition between PWM and low ripple Burst Mode operation is seamless, and will not disturb the output voltage.

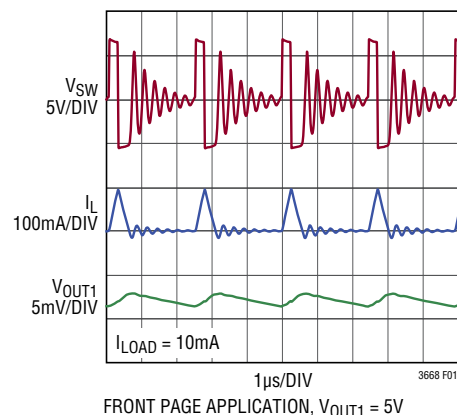

**Figure 1. Burst Mode Operation**



## APPLICATIONS INFORMATION

### BOOST and IN3/BD Pin Considerations

Capacitor C2 and the internal boost Schottky diode (see the Block Diagram) are used to generate a boost voltage that is higher than the input voltage. In most cases a 0.22 $\mu$ F capacitor will work well. Figure 2 shows two ways to arrange the boost circuit. The BOOST pin must be more than 1.9V above the SW pin for best efficiency. For outputs of 2.2V and above, the standard circuit (Figure 2a) is best. For outputs between 2.2V and 2.5V, use a 0.47 $\mu$ F boost capacitor. For output voltages below 2.2V, the boost diode can be tied to the input (Figure 2b), or to another external supply greater than 2.2V. However, the circuit in Figure 2a is more efficient because the BOOST pin current and IN3/BD pin quiescent current come from a lower voltage source. Also, be sure that the maximum voltage ratings of the BOOST and IN3/BD pins are not exceeded.

The minimum operating voltage of an LT3668 application is limited by the minimum input voltage (4.3V) and by the maximum duty cycle as outlined in a previous section. For proper start-up, the minimum input voltage is also limited by the boost circuit. If the input voltage is ramped slowly, the boost capacitor may not be fully

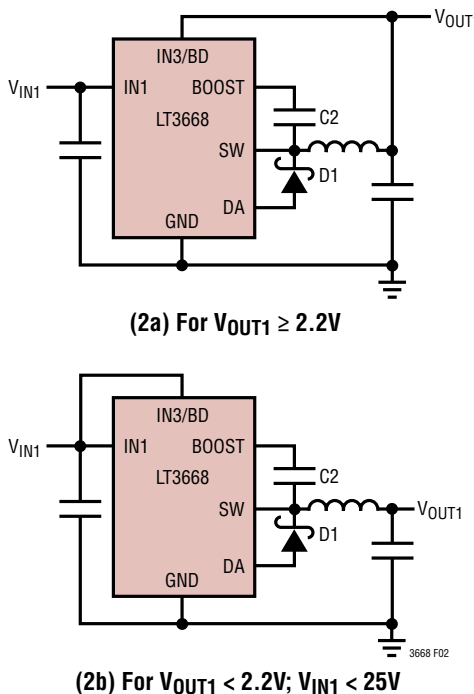

Figure 2. Two Circuits for Generating the Boost Voltage

charged. Because the boost capacitor is charged with the energy stored in the inductor, the circuit relies on some minimum load current to get the boost circuit running properly. This minimum load depends on input and output voltages, and on the arrangement of the boost circuit. The minimum load generally goes to zero once the circuit has started. Figure 3 shows a plot of minimum load to start and to run as a function of input voltage. In many cases the discharged output capacitor will present a load to the switcher, which will allow it to start. The plots show the worst-case situation where  $V_{IN1}$  is ramping very slowly. For lower start-up voltage, the boost diode can be tied to  $V_{IN1}$ ; however, this restricts the input range to one-half of the absolute maximum rating of the BOOST pin.

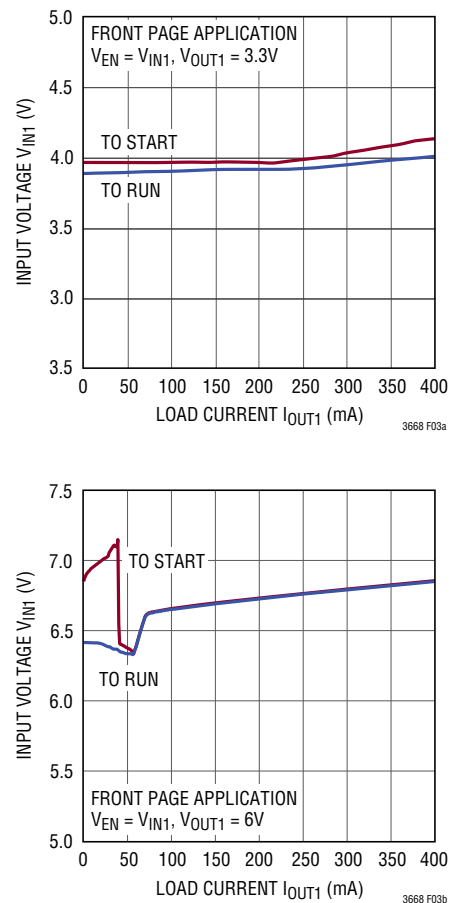

Figure 3. The Minimum Input Voltage Depends on Output Voltage, Load Current and Boost Circuit

## APPLICATIONS INFORMATION

### Shorted and Reversed Input Protection

If the inductor is chosen so that it won't saturate excessively, the switching regulator will tolerate a shorted output. There is another situation to consider in systems where the output will be held high when the input to the LT3668 is absent. This may occur in battery charging applications or in battery backup systems where a battery or some other supply is diode ORed with the switching regulator's output. If the IN1 pin is allowed to float and the EN pin is held high (either by a logic signal or because it is tied to IN1), then the LT3668's internal circuitry will pull its quiescent current through the SW pin. This is fine if the system can tolerate a few  $\mu\text{A}$  in this state. If the EN pin is grounded, the SW pin current will drop to  $0.7\mu\text{A}$ . However, if the IN1 pin is grounded while the output is held high, regardless of EN, parasitic diodes inside the LT3668 can pull current from the output through the SW pin and the IN1 pin. Figure 4 shows a circuit that will run only when the input voltage is present and that protects against a shorted or reversed input.

### LDOs

#### Adjustment Inputs

Each LDO output voltage of the LT3668 follows the voltage at the corresponding adjustment pin ADJ2/ADJ3. Each adjustment pin is pulled down by an internal current source (typically  $200\text{nA}$  at  $25^\circ\text{C}$ ). This current must be taken into consideration if an adjustment pin is to be driven by a high impedance resistive divider.

Even if the voltage at ADJ2/ADJ3 is below the minimum input voltage, the corresponding output will always be regulated to a voltage equal or below the voltage at ADJ2/ADJ3.

Any noise present at an adjustment pin is transferred to the corresponding output, in particular low frequency noise. See the LDO transfer function in the Typical Performance Characteristics section. Reference voltage noise can be reduced by connecting a capacitor from ADJ2/ADJ3 to ground. However, if the reference voltage is derived from the resistive divider of the switching regulator as shown in the application on page 1, no such bypass capacitor is allowed as it would impair the switching regulator's stability.

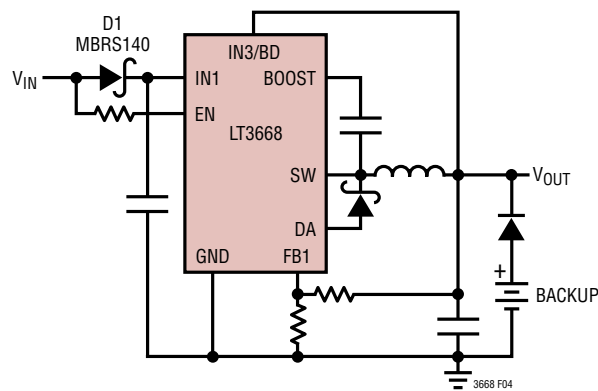

**Figure 4. Diode D1 Prevents a Shorted Input from Discharging a Backup Battery Tied to the Output. It Also Protects the Circuit from a Reversed Input, in Which Case the Resistor at the EN Pin Limits the Current Drawn from That Pin. The LT3668 Runs Only When the Input Is Present**

## APPLICATIONS INFORMATION

### Input Capacitance and Stability

Each LDO is stable with an input capacitor typically between  $1\mu\text{F}$  and  $10\mu\text{F}$ . This input capacitor must be placed as close as possible to the corresponding input pin. Applications operating with smaller input to output differential voltages and that experience large load transients may require a higher input capacitor value to prevent input voltage droop and letting the regulator enter dropout.

Very low ESR ceramic capacitors may be used. However, in cases where long wires connect the power supply to the LDOs input and ground, use of low value input capacitors may result in instability. The resonant LC tank circuit formed by the wire inductance and the input capacitor is the cause and not a result of LDO instability.

The minimum input capacitance needed to stabilize the application also varies with power supply output impedance variations. Placing additional capacitance on an LDO's output also helps. However, this requires an order of magnitude more capacitance in comparison with additional input bypassing. Series resistance between the supply and an LDO's input also helps stabilize the application; as little as  $0.1\Omega$  to  $0.5\Omega$  suffices. This impedance dampens the LC tank circuit at the expense of dropout voltage. A better alternative is to use higher ESR tantalum or electrolytic capacitors at the input in place of ceramic capacitors.

### Output Capacitance, Transient Response, Stability

Each LT3668's LDO is stable with a wide range of output capacitors. The ESR of the output capacitor affects stability, most notably with small capacitors. Use a minimum output capacitor of  $10\mu\text{F}$  to prevent oscillations. The ESR of the output capacitor must not exceed  $3\Omega$ .

The LT3668 is a micropower device and output load transient response is a function of output capacitance. Larger values of output capacitance decrease the peak deviations and provide improved transient response for larger load current changes, especially for low output voltages. Bypass capacitors, used to decouple individual components powered by the LT3668, increase the effective output capacitor value. For applications with large load current transients, a low ESR ceramic capacitor in parallel with a bulk tantalum capacitor often provides an optimally damped response.

Note that some ceramic capacitors have a piezoelectric response. A piezoelectric device generates voltage across its terminals due to mechanical stress, similar to the way a piezoelectric accelerometer or microphone works. For a ceramic capacitor, the stress is induced by vibrations in the system or thermal transients. The resulting voltages produced cause appreciable amounts of noise. A ceramic capacitor produced the trace in Figure 5 in response to light tapping from a pencil. Similar vibration induced behavior can masquerade as increased output voltage noise.

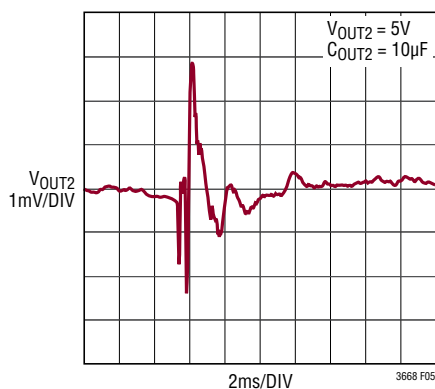

Figure 5. Noise Resulting from Tapping On a Ceramic Capacitor

## APPLICATIONS INFORMATION

### External Programmable Current Limit, Enable

Each EN/ILIM pin (EN2/ILIM2 and EN3/ILIM3) is the collector of a PNP which mirrors the corresponding LDO's output at a ratio of 1:799 (see Block Diagram). The EN2/ILIM2 and EN3/ILIM3 pins are also the inputs to precision current limit amplifiers. If an output load increases to the point where it causes the corresponding current limit amplifier input voltage to reach 0.4V, the current limit amplifier takes control of output regulation so that its input clamps at 0.4V, regardless of the output voltage. The current limit threshold ( $I_{LIMIT}$ ) of an LDO is set by attaching a resistor ( $R_{IMAX}$ ) from the corresponding EN/ILIM pin to ground:

$$R_{IMAX} = \frac{799 \cdot 0.4V}{I_{LIM}} - 80\Omega$$

In order to maintain stability, each EN/ILIM pin requires a 47nF capacitor from that pin to ground.

In cases where the input to output voltage differential exceeds 10V, foldback current limit will lower the internal current level limit, possibly causing it to preempt the external programmable current limit. See the Internal Current Limit vs Input/Output Differential graph in the Typical Performance Characteristics section.

If an external current limit is not needed, the corresponding EN/ILIM pin must be connected to ground, in which case no capacitor is required.

Each LDO can be individually shut down by pulling its EN/ILIM pin above 1.2V (1V typical). Note that in this case this pin will draw up to 500 $\mu$ A in certain operating conditions until the LDO is shut down, which the circuit driving this pin must be able to deliver. When an EN/ILIM pin is only used to enable/disable an LDO, no capacitor is required on this pin.

### Overload Recovery

Each LDO of the LT3668 has a safe operating area protection, which decreases current limit as input-to-output voltage increases, and keeps the power transistor inside a safe operating region for all values of input-to-output voltage. Each LDO provides some output current at all

values of input-to-output voltage up to the device breakdown. When power is first applied to an LDO, the input voltage rises and the output follows the input; allowing the regulator to start-up into very heavy loads. During start-up, as the input voltage is rising, the input-to-output voltage differential is small, allowing the regulator to supply large output currents. With a high input voltage, a problem can occur wherein the removal of an output short will not allow the output to recover. The problem occurs with a heavy output load when the input voltage is high and the output voltage is low. Common situations are: immediately after the removal of a short-circuit or if an LDO is enabled via its EN/ILIM pin after the input voltage is already turned on. In such cases, the regulator would have to operate its power device outside its safe operating area (high voltage and high current) in order to bring up the output voltage. Since this is prevented by the safe operating area protection, the output gets stuck at a low voltage. Essentially, the load line for such a load intersects the output current curve at two points, resulting in two stable output operating points for the regulator. With this double intersection, the input power supply needs to be cycled down to zero and brought up again to make the output recover.

### Protection Features

The LT3668 LDO's protect against reverse-input voltages, reverse-output voltages and reverse output-to-input voltages. Current limit protection and thermal overload protection protect the LDOs against current overload conditions at their outputs. For normal operation, do not exceed the maximum operating junction temperature. The LT3668 IN2 pin withstands reverse voltages of 45V. The device limits current flow to less than 300 $\mu$ A (typically less than 10 $\mu$ A) and no negative voltages appear at OUT2. The LDOs incur no damage if their outputs are pulled below ground. If an input is left open circuit or grounded, the corresponding output can be pulled below ground by 45V. No current flows through the pass transistor from the output. If the input is powered by a voltage source, the output sources current equal to its current limit capability and the LT3668 protects itself by thermal limiting. Note that the externally programmable current limit is less accurate if the output is pulled below ground.

## APPLICATIONS INFORMATION

### COMMON

#### Ceramic Capacitor Characteristics

Give extra consideration to the use of ceramic capacitors. Manufacturers make ceramic capacitors with a variety of dielectrics, each with different behavior across temperature and applied voltage. The most common dielectrics are specified with EIA temperature characteristic codes of Z5U, Y5V, X5R and X7R. The Z5U and Y5V dielectrics provide high C-V products in a small package at low cost, but exhibit strong voltage and temperature coefficients, as can be seen for Y5V in Figures 6 and 7. When used with a 5V regulator, a 16V 10 $\mu$ F Y5V capacitor can exhibit an effective value as low as 1 $\mu$ F to 2 $\mu$ F for the DC bias voltage applied, and over the operating temperature range. The

X5R and X7R dielectrics yield much more stable characteristics and are more suitable for use as input and output capacitors. The X7R type works over a wider temperature range and has better temperature stability, while the X5R is less expensive and is available in higher values. Still exercise care when using X5R and X7R capacitors; the X5R and X7R codes only specify operating temperature range and maximum capacitance change over temperature. Capacitance change due to DC bias with X5R and X7R capacitors is better than Y5V and Z5U capacitors, but can still be significant enough to drop capacitor values below appropriate levels. Capacitor DC bias characteristics tend to improve as component case size increases, but expected capacitance at operating voltage should be verified.

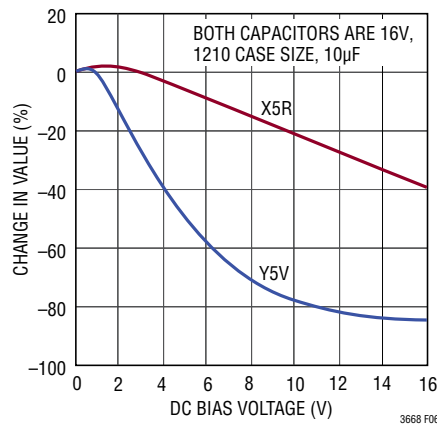

Figure 6. Ceramic Capacitor DC Bias Characteristics

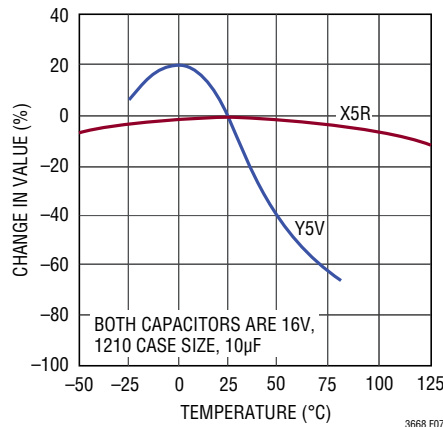

Figure 7. Ceramic Capacitor Temperature Characteristics

## APPLICATIONS INFORMATION

### PCB Layout

For proper operation and minimum EMI, care must be taken during printed circuit board layout. Figure 8 shows the recommended component placement with trace, ground plane and via locations. Note that large, switched currents flow in the LT3668's IN1, SW, GND and DA pins, the catch diode and the input capacitor. The loop formed by these components should be as small as possible. These components, along with the inductor and output capacitor, should be placed on the same side of the circuit board, and their connections should be made on that layer. Place a local, unbroken ground plane below these components.

The SW and BOOST nodes should be as small as possible. Keep the FB1 node small so that the ground traces will shield it from the SW and BOOST nodes. The exposed pad must be soldered such that it can act as a heat sink. (See High Temperature Considerations section.)

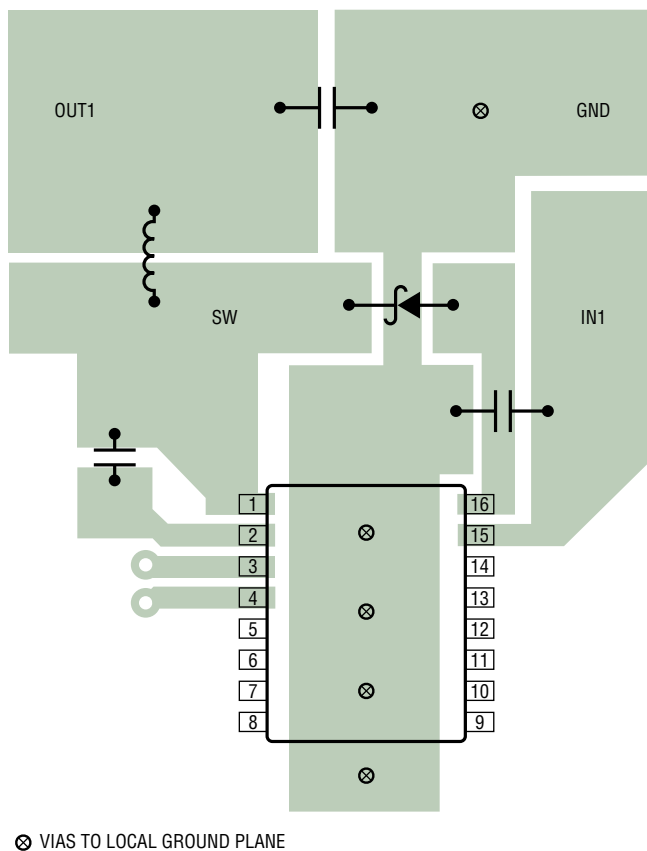

**Figure 8. Good PCB Layout Ensures Proper, Low EMI Operation**

### Hot Plugging Safely

The small size, robustness and low impedance of ceramic capacitors make them an attractive option for the input bypass capacitors of LT3668 circuits. However, these capacitors can cause problems if the LT3668 is plugged into a live supply. The low loss ceramic capacitor, combined with stray inductance in series with the power source, forms an under damped tank circuit, and the voltage at the input pins of the LT3668 can ring to twice their nominal input voltage, possibly exceeding the LT3668's rating and damaging the part. If the input supply is poorly controlled or the user will be plugging the LT3668 into an energized supply, the input network should be designed to prevent this overshoot. See Linear Technology Application Note 88 for a complete discussion.

### High Temperature Considerations

The LT3668's maximum rated junction temperature of 125°C limits its power handling capability.

Power dissipation within the switching regulator can be estimated by calculating the total power loss from an efficiency measurement and subtracting inductor loss. Be aware that at high ambient temperatures the external Schottky diode will have significant leakage current (see Typical Performance Characteristics), increasing the quiescent current of the switching regulator.

The power dissipation of each LDO is comprised of two components. Each power device dissipates:

$$P_{PASS} = (V_{IN} - V_{OUT}) \cdot I_{OUT}$$

where  $P_{PASS}$  is the power,  $V_{IN}$  the input voltage,  $V_{OUT}$  the output voltage, and  $I_{OUT}$  the output current. The base currents of the LDO power PNP transistors flow to ground internally and are the major component of the ground current. For each LDO, this causes a power dissipation  $P_{GND}$  of:

$$P_{GND} = V_{IN} \cdot I_{GND}$$

where  $V_{IN}$  is the input voltage and  $I_{GND}$  the ground current generated by the corresponding power device. GND pin current is determined by the current gain of the power



## APPLICATIONS INFORMATION

PNP, which has a typical value of 40 for the purpose of this calculation:

$$I_{\text{GND}} = \frac{I_{\text{OUT}}}{40}$$

The total power dissipation equals the sum of the power loss in the switching regulator and the two LDO components listed above.

The LT3668 has internal thermal limiting that protects the device during overload conditions. If the junction temperature reaches the thermal shutdown threshold, the LT3668 will shut down the LDOs and stop switching to prevent internal damage due to overheating. For continuous normal conditions, do not exceed the maximum operating junction temperature. Carefully consider all sources of thermal resistance from junction-to-ambient including other nearby heat sources. The LT3668 package has an exposed pad that must be soldered to a ground plane to act as heat sink. To keep thermal resistance low, extend the ground plane as much as possible, and add thermal vias under and near the LT3668 to additional ground planes within the circuit board and on the bottom side.

The die temperature rise is calculated by multiplying the power dissipation of the LT3668 by the thermal resistance from junction to ambient. Example: Given the front page application with maximum output current, an input voltage of 12V and a maximum ambient temperature of 85°C, what will the maximum junction temperature be?

As can be seen from the Typical Performance Characteristics, the switching regulator efficiency approaches 85% at 400mA output current. This leads to a power loss,  $P_{\text{LOSS}}$ , of:

$$P_{\text{LOSS}} = 5V \cdot 400\text{mA} \cdot \left( \frac{1}{0.85} - 1 \right) = 353\text{mW}$$

(For the sake of simplicity and as a conservative estimate assume that all of this power is dissipated in the LT3668.) The power dissipations of the LDO power devices are:

$$P_{\text{PASS2}} = (5V - 2.5V) \cdot 100\text{mA} = 250\text{mW}$$

$$P_{\text{PASS3}} = (5V - 3.3V) \cdot 100\text{mA} = 170\text{mW}$$

For 100mA load current a maximum ground current of 2.5mA is to be expected. Thus, the corresponding power dissipations are:

$$P_{\text{GND2}} = P_{\text{GND3}} = 5V \cdot 2.5\text{mA} = 12.5\text{mW}$$

Finally, the total power dissipation is:

$$P_{\text{TOT}} = P_{\text{LOSS}} + P_{\text{PASS2}} + P_{\text{PASS3}} + P_{\text{GND2}} + P_{\text{GND3}} = 786\text{mW}$$

Since the MSOP package has a thermal resistance of approximately 40°C/W, this total power dissipation would raise the junction temperature above ambient by:

$$0.786\text{W} \cdot 40^\circ\text{C/W} = 32^\circ\text{C}$$

With the assumed maximum ambient temperature of 85°C, this puts the maximum junction temperature at:

$$T_{\text{JMAX}} = 85^\circ\text{C} + 32^\circ\text{C} = 117^\circ\text{C}$$

### Other Linear Technology Publications

Application Notes 19, 35 and 44 contain more detailed descriptions and design information for buck regulators and other switching regulators. The LT1376 data sheet has a more extensive discussion of output ripple, loop compensation and stability testing. Design Note 318 shows how to generate a bipolar output supply using a buck regulator.





TYPICAL APPLICATIONS

Using Digital Output of a Microcontroller as Reference Voltage

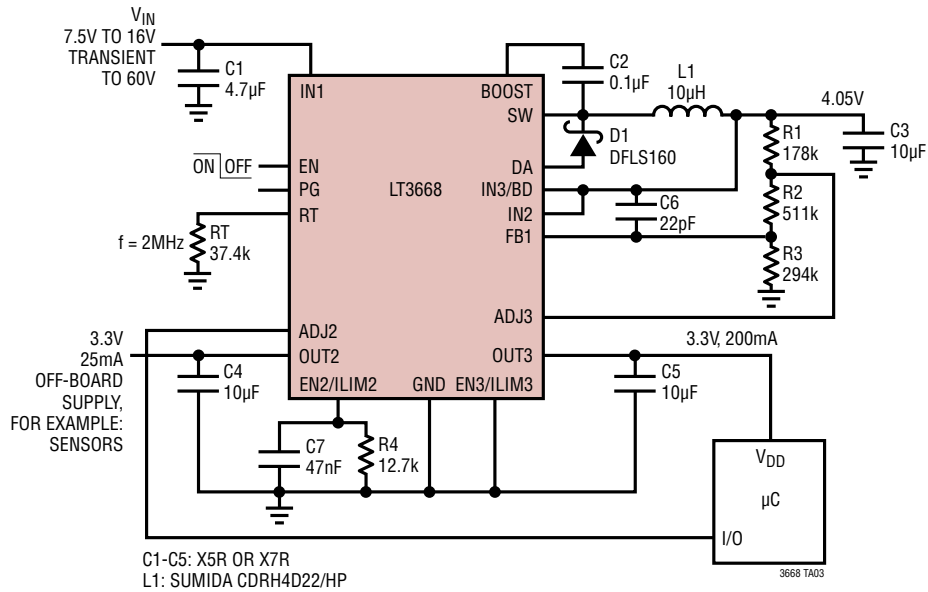

## TYPICAL APPLICATIONS

### Three Matching 5V Supplies

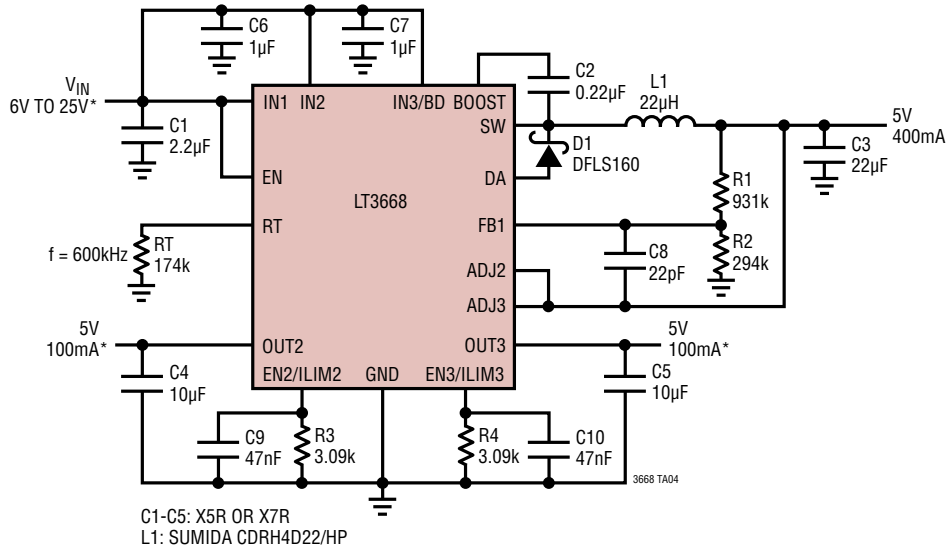

\* 100mA CURRENT LIMIT. DERATE OUTPUT CURRENT AT HIGHER AMBIENT TEMPERATURES AND INPUT VOLTAGES TO MAINTAIN JUNCTION TEMPERATURE BELOW THE ABSOLUTE MAXIMUM

### Programming LDO Current Limits with a Digital/Analog Converter

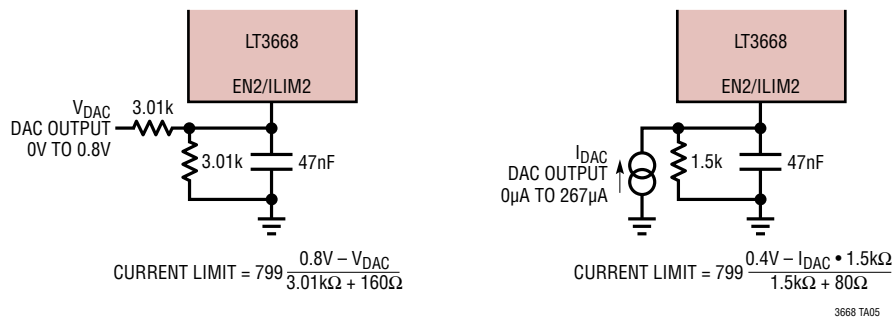

3668 TA05

# PACKAGE DESCRIPTION

Please refer to <http://www.linear.com/designtools/packaging/> for the most recent package drawings.

## MSE Package 16-Lead Plastic MSOP, Exposed Die Pad (Reference LTC DWG # 05-08-1667 Rev F)

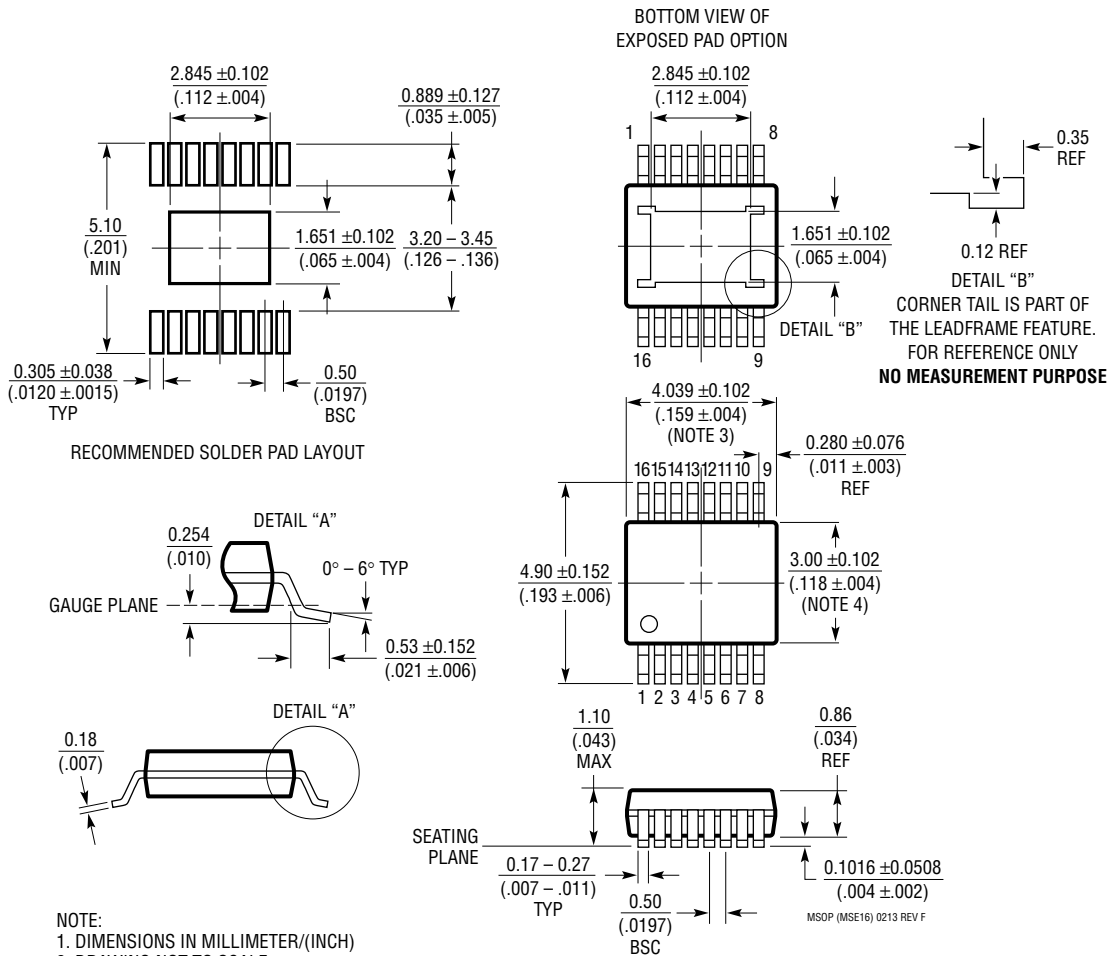

- NOTE:
1. DIMENSIONS IN MILLIMETER/(INCH)
  2. DRAWING NOT TO SCALE
  3. DIMENSION DOES NOT INCLUDE MOLD FLASH, PROTRUSIONS OR GATE BURRS. MOLD FLASH, PROTRUSIONS OR GATE BURRS SHALL NOT EXCEED 0.152mm (.006") PER SIDE
  4. DIMENSION DOES NOT INCLUDE INTERLEAD FLASH OR PROTRUSIONS. INTERLEAD FLASH OR PROTRUSIONS SHALL NOT EXCEED 0.152mm (.006") PER SIDE
  5. LEAD COPLANARITY (BOTTOM OF LEADS AFTER FORMING) SHALL BE 0.102mm (.004") MAX
  6. EXPOSED PAD DIMENSION DOES INCLUDE MOLD FLASH. MOLD FLASH ON E-PAD SHALL NOT EXCEED 0.254mm (.010") PER SIDE.

## TYPICAL APPLICATION

### 5V/0.75A Supply with Two 0.2A Tracking Outputs

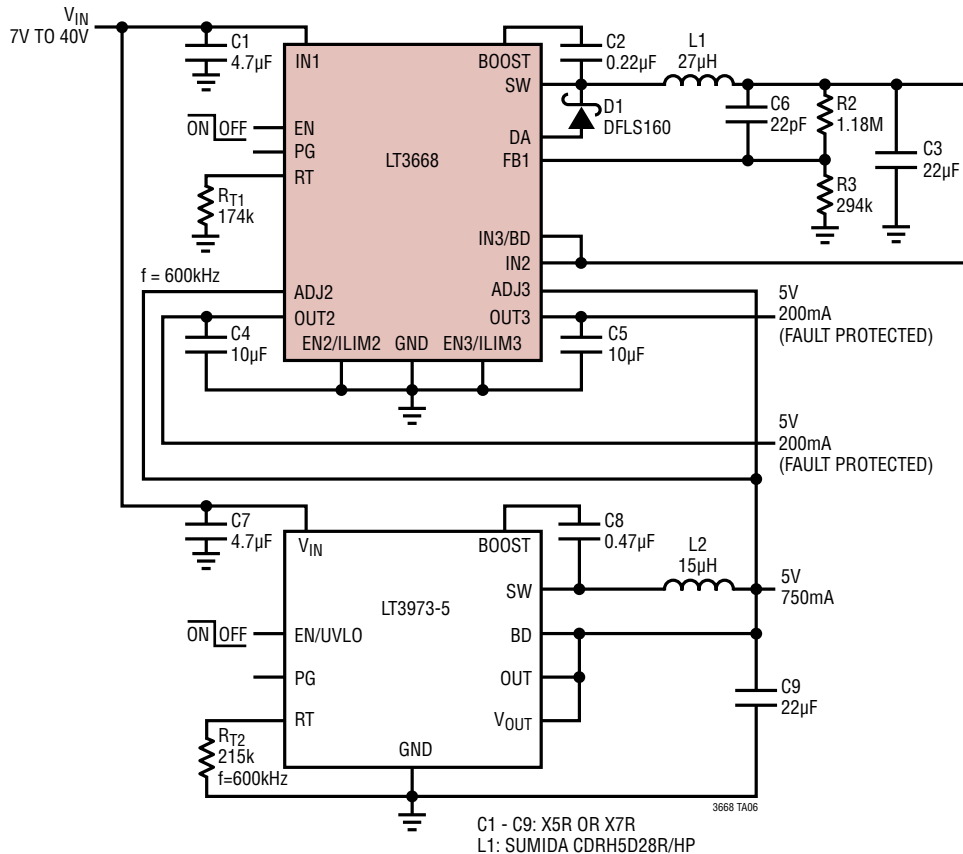

## RELATED PARTS

PART NUMBER	DESCRIPTION	COMMENTS
<a href="#">LT3667</a>	40V, 400mA Step-Down Switching Regulator with Dual Fault Protected LDOs	$V_{IN}$ : 4.3V to 40V, $V_{OUT(MIN)}$ = 0.8V, $I_Q$ = 50mA, $I_{SD}$ < 1 $\mu$ A, MSOP-16E, 3mm $\times$ 5mm QFN-24,
<a href="#">LT3500</a>	36V (40V <sub>MAX</sub> ), 2A ( $I_{OUT}$ ), 2.2MHz Step-Down Switching Regulator with LDO Controller	$V_{IN}$ : 3V to 36V, $V_{OUT(MIN)}$ = 0.8V, $I_Q$ = 2.5mA, $I_{SD}$ < 12 $\mu$ A, 3mm $\times$ 3mm DFN-10, MSOP-16E
<a href="#">LT1939</a>	25V, 2A ( $I_{OUT}$ ), 2.2MHz Step-Down Switching Regulator with LDO Controller	$V_{IN}$ : 3V to 25V, $V_{OUT(MIN)}$ = 0.8V, $I_Q$ = 2.5mA, $I_{SD}$ < 12 $\mu$ A, 3mm $\times$ 3mm DFN-10, MSOP-16E
<a href="#">LT3694</a>	36V (70V <sub>MAX</sub> ), 2.6A ( $I_{OUT}$ ), 2.5MHz Step-Down Switching Regulator with Dual LDO Controller	$V_{IN}$ : 4V to 36V, $V_{OUT(MIN)}$ = 0.8V, $I_Q$ = 1mA, $I_{SD}$ < 1 $\mu$ A, 4mm $\times$ 5mm QFN-28, TSSOP-20E
<a href="#">LT3507/LT3507A</a>	36V, 2.5MHz, Triple (2.4A + 1.5A + 1.5A ( $I_{OUT}$ )) with LDO Controller High Efficiency Step-Down DC/DC Converter	$V_{IN}$ : 4V to 36V, $V_{OUT(MIN)}$ = 0.8V, $I_Q$ = 7mA, $I_{SD}$ = 1 $\mu$ A, 5mm $\times$ 7mm QFN-38
<a href="#">LT3970</a>	40V, 350mA ( $I_{OUT}$ ), 2.2MHz Step-Down Switching Regulator with $I_Q$ = 2.5 $\mu$ A	$V_{IN}$ : 4.2V to 40V, $V_{OUT(MIN)}$ = 1.2V, $I_Q$ = 2.5 $\mu$ A, $I_{SD}$ < 1 $\mu$ A, 3mm $\times$ 2mm DFN, MSOP-10
<a href="#">LT3502/LT3502A</a>	40V, 500mA ( $I_{OUT}$ ), 1.1MHz/2.2MHz Step-Down Switching Regulator	$V_{IN}$ : 3V to 40V, $V_{OUT(MIN)}$ = 0.8V, $I_Q$ = 1.5mA, $I_{SD}$ < 1 $\mu$ A, 2mm $\times$ 2mm DFN-8, MSOP-10E