

5 Amps, 500Volts N-Channel MOSFET

■ Description

The ET830 N-Channel enhancement mode silicon gate power MOSFET is designed for high voltage, high speed power switching applications such as switching regulators, switching converters, solenoid, motor drivers, relay drivers.

■ Features

- $R_{DS(ON)} = 1.5\Omega @ V_{GS} = 10V$
- Low gate charge (typical 20nC)
- Fast switching capability
- Avalanche energy specified
- Improved dv/dt capability

■ Symbol

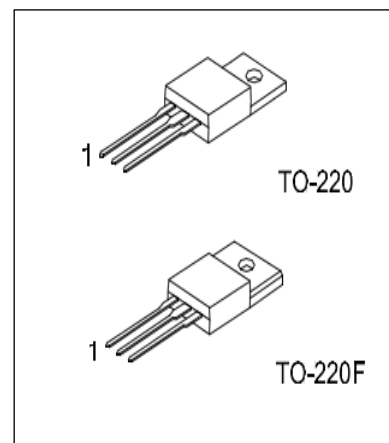
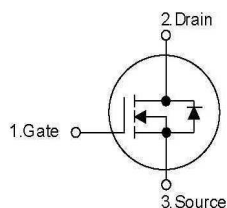

■ Absolute Maximum Ratings ($T_c=25^\circ\text{C}$, unless otherwise specified)

Parameter	Symbol	Ratings		Units	
		TO-220	TO-220F		
Drain-Source Voltage	V_{DSS}	500		V	
Gate-Source Voltage	V_{GSS}	± 30		V	
Drain Current Continuous	I_D	$T_c=25^\circ\text{C}$	5.0	5.0*	A
		$T_c=100^\circ\text{C}$	3.0	3.0*	A
Drain Current Pulsed (Note 1)	I_{DP}	20	20*	A	
Avalanche Energy	Repetitive (Note 1)	E_{AR} 7.6		mJ	
	Single Pulse (Note 2)	E_{AS} 305		mJ	
Peak Diode Recovery dv/dt (Note 3)	dv/dt	4.5		V/ns	
Total Power Dissipation	P_D	$T_c=25^\circ\text{C}$	76	40	W
		Derate above 25°C	0.6	0.32	W/ $^\circ\text{C}$
Junction Temperature	T_J	+150		$^\circ\text{C}$	
Storage Temperature	T_{STG}	-55~+150		$^\circ\text{C}$	

* Drain current limited by maximum junction temperature.

■ Thermal Characteristics

Parameter	Symbol	Ratings		Units
		TO-220	TO-220F	
Thermal Resistance Junction-Ambient	R_{thJA}	62.5		°C/W
Thermal Resistance, Case-to-Sink Typ.	R_{thCS}	0.5	--	
Thermal Resistance Junction-Case	R_{thJC}	1.2	3.65	

■ Electrical Characteristics ($T_J=25^{\circ}\text{C}$, unless Otherwise specified.)

Parameter	Symbol	Test Conditions	Min	Typ	Max	Units	
Off Characteristics							
Drain-Source Breakdown Voltage	BV_{DSS}	$V_{GS}=0V, I_D=250\mu A$	500	--	--	V	
Zero Gate Voltage Drain Current	I_{DSS}	$V_{DS}=500V, V_{GS}=0V$	--	--	1	μA	
		$V_{DS}=400V, T_C=125^{\circ}\text{C}$	--	--	10	μA	
Gate-Body Leakage Current	Forward	I_{GSS}	$V_{GS}=30V, V_{DS}=0V$	--	--	100	nA
	Reverse					-100	nA
Breakdown Voltage Temperature Coefficient	$\Delta BV_{DSS}/\Delta T_J$	$I_D=250\mu A$	--	0.6	--	V/°C	
On Characteristics							
Gate Threshold Voltage	$V_{GS(TH)}$	$V_{DS}=V_{GS}, I_D=250\mu A$	2.0	--	4.0	V	
Static Drain-Source On-Resistance	$R_{DS(ON)}$	$V_{DS}=10V, I_D=2.5A$	--	1.10	1.5	Ω	
Dynamic Characteristics							
Input Capacitance	C_{ISS}	$V_{DS}=25V, V_{GS}=0V,$ $f=1\text{MHz}$	--	520	--	pF	
Output Capacitance	C_{OSS}		--	80	--	pF	
Reverse Transfer Capacitance	C_{RSS}		--	15	--	pF	
Switching Characteristics							
Turn-On Delay Time	$t_{D(ON)}$	$V_{DD}=250V, I_D=5.0A,$ $R_G=25\Omega$ (Note 4, 5)	--	10	--	ns	
Rise Time	t_R		--	50	--	ns	
Turn-Off Delay Time	$t_{D(OFF)}$		--	50	--	ns	
Fall Time	t_F		--	50	--	ns	
Total Gate Charge	Q_G	$V_{DS}=400V, I_D=5.0A,$ $V_{GS}=10V$ (Note 4, 5)	--	20	--	nC	
Gate-Source Charge	Q_{GS}		--	2.5	--	nC	
Gate-Drain Charge	Q_{GD}		--	10	--	nC	
Drain-Source Diode Characteristics							
Drain-Source Diode Forward Voltage	V_{SD}	$V_{GS}=0V, I_{SD}=5.0A$	--	--	1.4	V	
Continuous Drain-Source Current	I_{SD}		--	--	5.0	A	
Pulsed Drain-Source Current	I_{SM}		--	--	20.0	A	
Reverse Recovery Time	t_{RR}	$I_{SD}=5.0A,$ $dI_{SD}/dt=100A/\mu s$ (Note 4)	--	260	--	ns	
Reverse Recovery Charge	Q_{RR}		--	2.0	--	μC	

1. Repetitive Rating : Pulse width limited by maximum junction temperature
2. $L = 22\text{ mH}, I_{AS} = 5.0\text{ A}, V_{DD} = 50\text{ V}, R_G = 25\ \Omega,$ Starting $T_J = 25^{\circ}\text{C}$
3. $I_{SD} \leq 5.0\text{ A}, di/dt \leq 200\text{ A}/\mu\text{ s}, V_{DD} \leq BV_{DSS},$ Starting $T_J = 25^{\circ}\text{C}$
4. Pulse Test : Pulse width $\leq 300\ \mu\text{ s},$ Duty cycle $\leq 2\%$
5. Essentially independent of operating temperature

■ Typical Characteristics

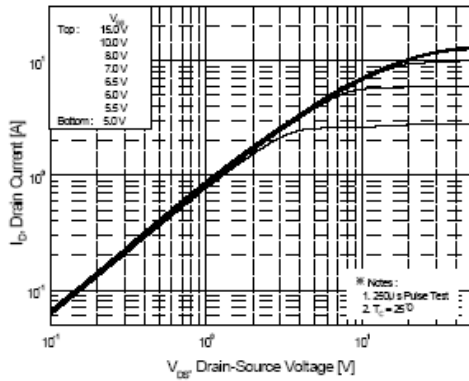

Figure 1. On-Region Characteristics

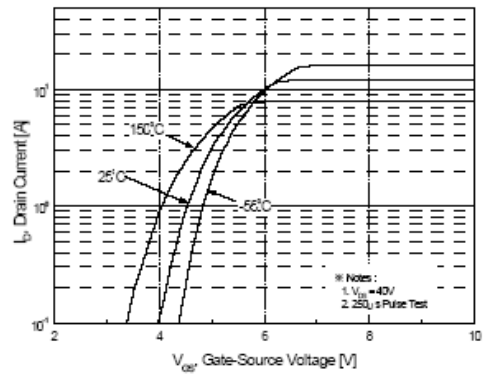

Figure 2. Transfer Characteristics

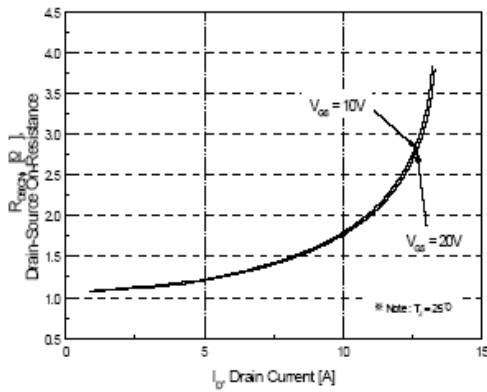

Figure 3. On-Resistance Variation vs. Drain Current and Gate Voltage

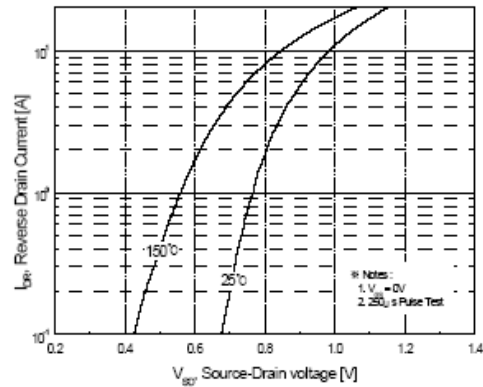

Figure 4. Body Diode Forward Voltage Variation with Source Current and Temperature

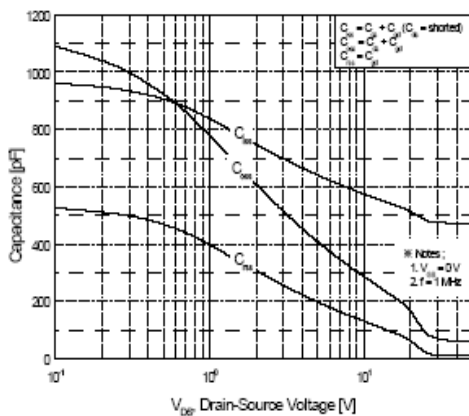

Figure 5. Capacitance Characteristics

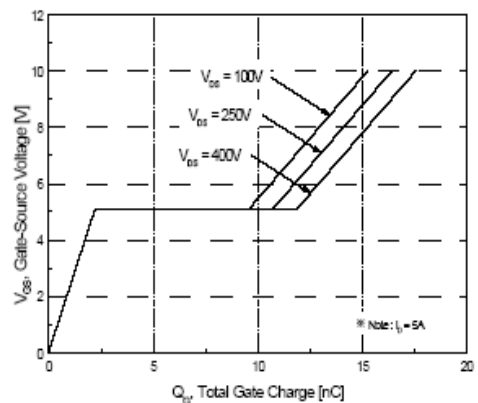

Figure 6. Gate Charge Characteristics

■ Typical Characteristics (Continued)

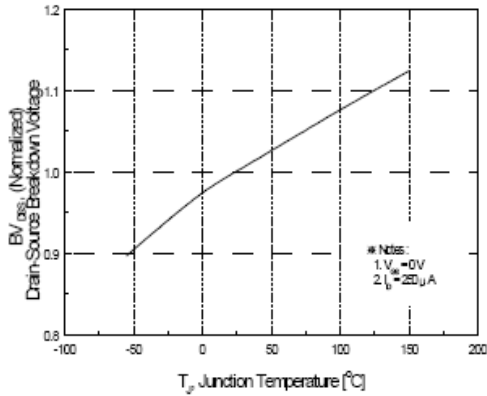

Figure 7. Breakdown Voltage Variation vs Temperature

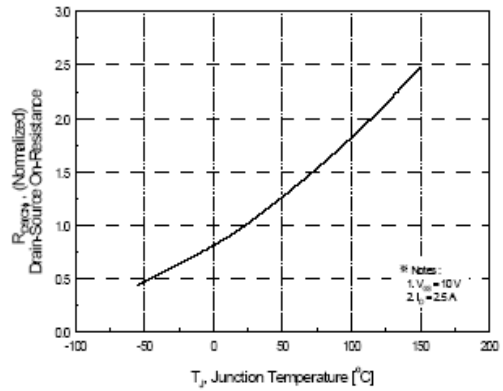

Figure 8. On-Resistance Variation vs Temperature

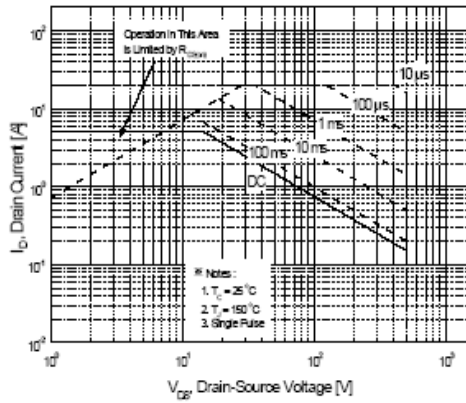

Figure 9-1. Maximum Safe Operating Area for TO220

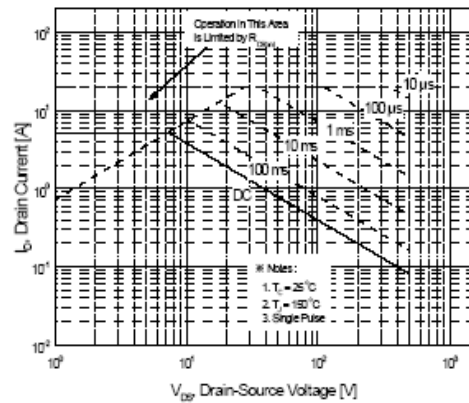

Figure 9-2. Maximum Safe Operating Area for TO220F

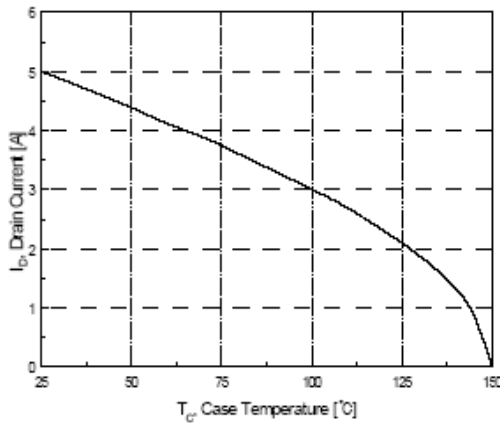
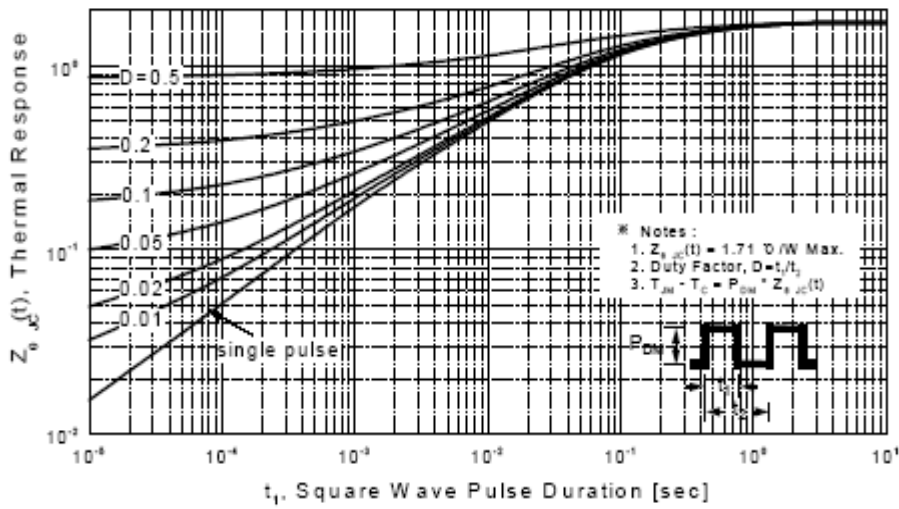
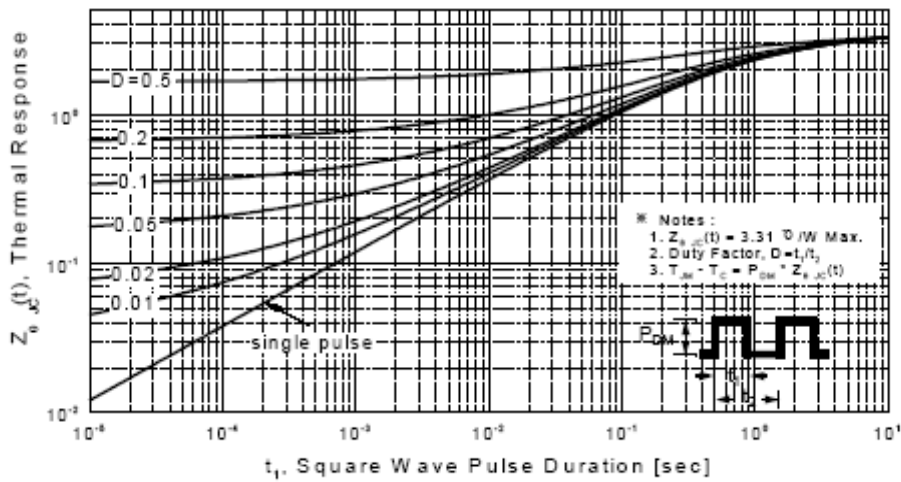

Figure 10. Maximum Drain Current vs Case Temperature

Typical Characteristics (Continued)

Figure 11-1. Transient Thermal Response Curve for TO220

Figure 11-2. Transient Thermal Response Curve for TO220F