

**5MVP3
MAIN BOARD
AT FORM FACTOR
USER'S MANUAL
(VER. 2.1)**

COPYRIGHT

THIS MANUAL AND THE INFORMATION CONTAINED HEREIN ARE PROTECTED BY COPYRIGHT. ALL RIGHTS ARE RESERVED.

WARNING AND DISCLAIMER

THIS MANUAL IS DESIGNED TO PROVIDE INFORMATION ABOUT THE PENTIUM® AGP MAIN BOARD. EVERY EFFORT HAS BEEN MADE TO MAKE THIS MANUAL AS ACCURATE AS POSSIBLE, BUT NO WARRANTY OR FITNESS IS IMPLIED. ALL THE INFORMATION IS PROVIDED ON AN 'AS IS' BASIS. THE AUTHOR AND HIS CORRESPONDING PUBLISHING COMPANY SHALL HAVE NEITHER LIABILITY NOR RESPONSIBILITY TO ANY PERSON OR ENTITY WITH RESPECT TO ANY LOSS OR DAMAGES ARISING FROM THE INFORMATION CONTAINED IN THIS MANUAL OR FROM THE USE OF THE SYSTEM BOARD THAT ACCOMPANIES IT. INFORMATION CONTAINED IN THIS MANUAL IS SUBJECT TO CHANGE WITHOUT NOTICE. THE MANUFACTURER OF THE SYSTEM BOARD WILL NOT BE HELD RESPONSIBLE FOR TECHNICAL OR EDITORIAL OMISSIONS MADE HEREIN, NOR FOR THE INCIDENTAL OR CONSEQUENTIAL DAMAGES RESULTING FROM ITS FURNISHING, PERFORMANCE, FUNCTIONALITY OR USE. SUBSEQUENT CHANGES TO THIS MANUAL WILL BE INCORPORATED INTO THE NEXT EDITION. WE WELCOME ANY SUGGESTION REGARDING THIS MANUAL OR OUR COMPUTER PRODUCTS.

TRADEMARKS

ALL TRADEMARKS ARE THE PROPERTY OF THEIR RESPECTIVE OWNERS.

TABLE OF CONTENTS

CHAPTER 1 INTRODUCTION.....	1
1-1 OVER VIEW	1
1-2 MAIN FEATURES.....	2
1-3 UNPACKING.....	3
1-4 QUICK REFERENCE FOR CD SOFTWARE DRIVERS.....	3
CHAPTER 2 MOTHER BOARD SPECIFICATION.....	4
2-1 MOTHER BOARD LAYOUT.....	4
2-2 JUMPER SETTINGS	5
2-3 SIMM INSTALLATION PROCEDURES.....	13
2-4 DIMM INSTALLATION PROCEDURES.....	14
2-5 MEMORY CHART.....	15
CHAPTER 3 BIOS SETUP.....	16
3-1 STANDARD CMOS SETUP.....	17
3-2 BIOS FEATURES SETUP.....	19
3-3 CHIPSET FEATURES SETUP.....	22
3-4 POWER MANAGEMENT SETUP.....	23
3-5 PNP/PCI CONFIGURATION.....	27
3-6 LOAD SETUP DEFAULTS.....	28
3-7 INTEGRATED PERIPHERALS.....	29

3-8 SUPERVISOR PASSWORD
.....32

3-9 IDE HDD AUTO DETECTION.....32

3-10 SAVE & EXIT SETUP.....35

3-11 EXIT WITHOUT
SAVING.....35

3-12 I/O & MEMORY
MAP.....36

3-13 TIME & DMA CHANNELS MAP..... 38

3-14 INTERRUPT
MAP.....38

3-15 RTC & CMOS RM
MAP.....39

3-16 CD DRIVER SET-UP AFTER INSTALLING WINDOWS
98.40

CAPTER 1 INTRODUCTION

1-1 OVERVIEW

5MVP3 MAIN BOARD COMBINES THE ADVANCED CAPABILITIES OF THE VIA® APOLLO MVP 3 CHIP SETS WITH A HIGH PERFORMANCE CONCURRENT PCI LOCAL BUS ARCHITECTURE TO PROVIDE THE IDEAL PLATFORM FOR UNLEASHING THE UNSURPASSED SPEED AND POWER OF THE INTEL® PENTIUM® PROCESSOR, CYRIX® 6X86M1/ 6X86LM1/ 6X86MX / 6X86MII AND AMD® K5/K6/K6-2 PROCESSORS, AND CAN BE EASILY UPGRADED FOR 321 PIN ZIF SOCKET. TO BE MORE SPECIFIC, THIS MAIN BOARD OFFERS 100MHZ CPU/DRAM BUS FREQUENCIES AND SUPPORT PC 100/66MHZ SDRAM OPTION WITH 100MHZ CPU.

THE PROCESSOR'S ADVANCED PERFORMANCE IS COMPLEMENTED BY A SECOND LEVEL WRITE BACK P B-SRAM UP TO 1MB AND MAIN MEMORY UP TO 1GB RAM. THE MAIN MEMORY IS INITIALED USING THE BOARD'S TWO 72-PIN SIMM SOCKETS AND TWO 168-PIN DIMM SOCKETS THAT ACCEPT EITHER THE NEW HIGH PERFORMANCE EDO, BEDO, OR FAST PAGE MODE DRAM.

VIA® MVP3 CHIP SET INTEGRATES A FULL SET OF I/O FEATURES ON BOARD, INCLUDING TWO 16550 UART COMPATIBLE SERIAL PORTS, ONE EPP/ECP CAPABLE PORT, ONE floppy disk controller, AND ONE INFRARED COMMUNICATION CONTROLLER. ONE CHIP BUILT IN ENHANCED IDE CONTROLLER PROVIDES CONVENIENT, SPEEDY PCI BUS MASTER CONNECTION CAPABLE OF FOUR IDE DEVICES, INCLUDING HARD DISK AND CD-ROM.

VIA® BUILDS ALL PRODUCTS TO EXACTING STANDARDS, USING THE HIGHEST QUALITY COMPONENTS AVAILABLE. WE ARE PROUD TO PROVIDE THIS SYSTEM BOARD AND HOPE IT BRINGS YOU YEARS OF RELIABLE SERVICE.

1-2 MAIN FEATURES

ITEM	DESCRIPTION
SOCKET 7	SUPPORTS CPU IN A 321 PIN ZIF SOCKET A. INTEL® PENTIUM®P54C /P55C MMX CPU B. CYRIX®6X86/6X86L/6X86MX/ MII C. AMD ® K5/K6/K6-2 PROCESSORS
CHIPSET	VIA® APOLLO MVP3 CHIPSET
CACHE	512K; 1024K
MEMORY	2 DIMM/ 2 SIMM DIMM A. SYNCHRONOUS DRAM WITH 168-PIN DIMM MODULES OF 8,16, 32, 64MB, 128MB FOR 66MHZ B. EDO RA M W ITH 168- PIN DIM M MODUL ES OF 8,1 6, 32 , 64MB, 128MB FOR 66MHZ(5V OR 3.3V) C. 100MHZ FREQ. CPU: PC-100 100 MHZ DIMM SIMM: TAKE UP TO 256MB RAM IN ONE BANK, USING 72-PIN SIMM M ODULES OF 1, 2, 4, 8, 1 6, 32, OR 64MB WITH SUPPORTS FOR EDO, BEDO OR FAST PAGE MODE MEMORY
AGP SLOT	AGP COMPLIANT WITH 1 X OR 2X MODE UP TO 133MHZ
EXP. SLOT	3*16-BIT ISA SLOTS AND 3* 32-BIT PCI EXPANSION SLOTS
I/O	INTEGRATED I TE I T8661F/RF MU LTII /O C HIPSET THAT OFFERS TWO 16550 UART COMPATIBLE SERIAL PORTS, ONE EPP/ECP CAPABLE PORT, ONE IR PORT, AND ONE FLOPPY DISK DRIVE CONNECTOR, IN-FRA-RED CONNECTOR
FLASH ROM	128KB
SIZE	22.0 X 24.0 CM
SPECIAL FEATURE	AT OR ATX POWER CONNECTOR

NOTE: 5MVP3 IS ESPECIALLY DESIGNED FOR AMD® K6 -PR300 3.45V V/O(66MHZ FREQ.) AND K 6-2 CPU WITH 100 MHZ FREQ. & 95MHZ K6-2 333 CPU.

1-3 UNPACKING

THE MAIN BOARD PACKAGE CONTAINS:

- * MVP3 MAIN BOARD
- * MANUAL
- * CABLES
- * DRIVER & UTILITY / CD

IF ANY OF THESE ITEMS IS MISSING OR DAMAGED, CONTACT THE DEALER FROM WHOM YOU PURCHASED. LEAVE THE 5MVP3 IN ITS ORIGINAL PACKING UNTIL YOU ARE READY TO INSTALL IT.

1.4 QUICK REFERENCE FOR CD SOFTWARE DRIVERS

THIS CD CONTAINS DRIVERS AS BELOW. READ "INDEX" BEFORE INSTALLING REQUIRED DRIVERS. "INDEX" FILE IS HTML FORMAT.

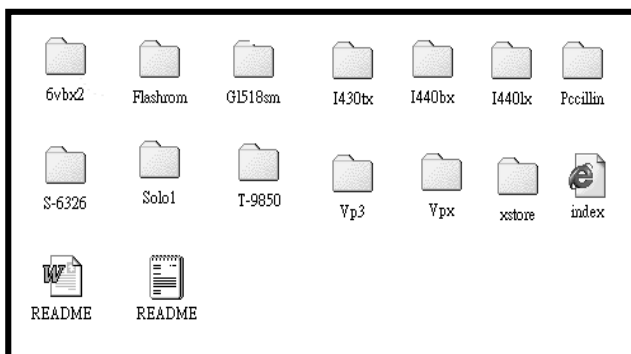

1. **MAIN BOARDS:** I440BX, I440EX, I440LX, I430TX, VIA® VPX, VP3, 691BX, 692BX PRO – BASED MAIN BOARDS
2. **A.G.P CARDS:** S-6326 AND T985
3. **SOLO-1:** ESS-SOLO-1 SOUND DRIVER
4. **GL518SM:** CPU VOLTAGE/TEMPERATURE AND FAN SPEED DETECTION SOFTWARE
5. **PCCILLIN:** ANTI-VIRUS PROTECTION SOFTWARE

- 6. XSTORE PRO IDE DRIVER: IDE BUS MASTER DRIVER FOR ULTRA DMA 33

CHAPTER 2 MOTHER BOARD SPECIFICATION

2-1 MOTHERBOARD LAYOUT

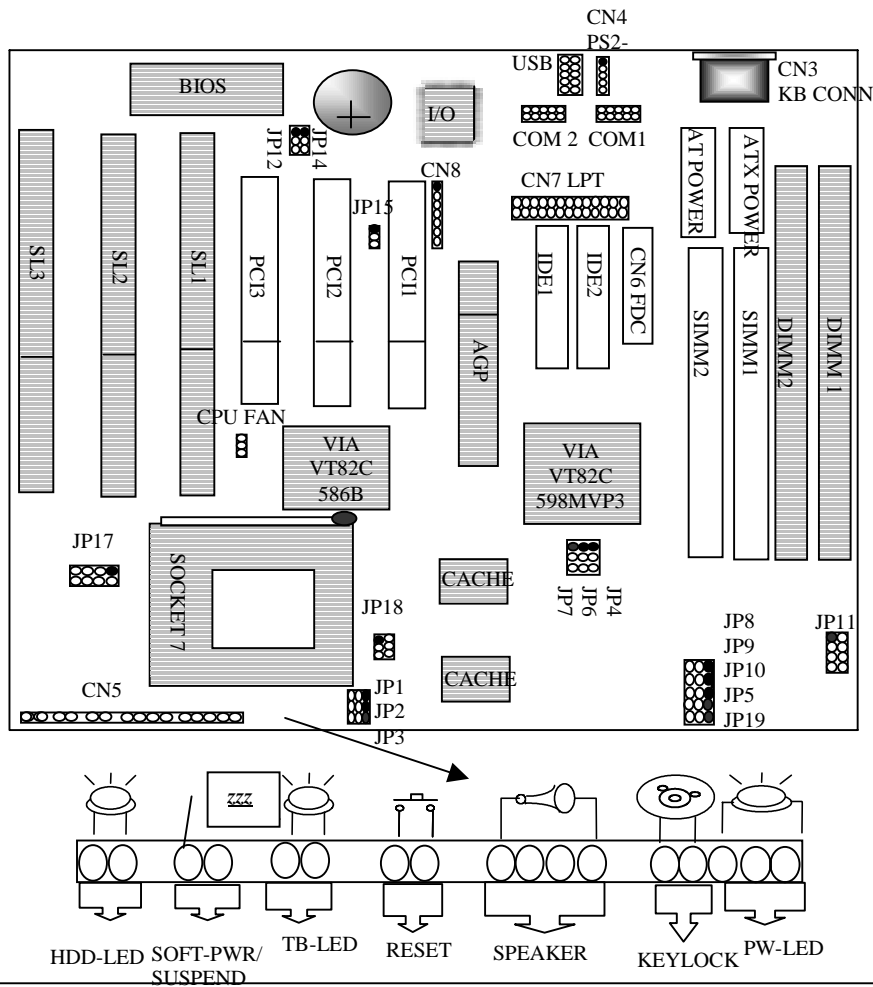

2-2 JUMPER SETTINGS

PLEASE MAKE SURE THE JUMPERS ARE CORRECTLY SET.

INTEL® PENTIUM® PROCESSOR INSTALLATION

CPU CLOCK	SYS. CLOCK	JP1	JP2	JP3	JP6	JP7	JP8	JP9	JP10	JP17	JP18	JP19	RATIO
P54C 100 MHZ 3.3V	66 MHZ	1-2	1-2	1-2	2-3	2-3	1-2	1-2	1-2	1-2, 5-6, 7-8	OPEN	1-2	1.5X
P54C 133 MHZ 3.3V	66 MHZ	2-3	1-2	1-2	2-3	2-3	1-2	1-2	1-2	1-2, 5-6, 7-8	OPEN	1-2	2X
P54C 166 MHZ 3.3V	66 MHZ	2-3	2-3	1-2	2-3	2-3	1-2	1-2	1-2	1-2, 5-6, 7-8	OPEN	1-2	2.5X
P55C 166 MHZ 2.8/3.3V	66 MHZ	2-3	2-3	1-2	2-3	2-3	1-2	1-2	1-2	7-8	1-2,3-4,5-6	1-2	2.5X
P54C 200 MHZ 3.3V	66 MHZ	1-2	2-3	1-2	2-3	2-3	1-2	1-2	1-2	1-2, 5-6, 7-8	OPEN	1-2	3X
P55C 200 MHZ 2.8/3.3V	66 MHZ	1-2	2-3	1-2	2-3	2-3	1-2	1-2	1-2	7-8	1-2,3-4,5-6	1-2	3X
P55C 233 MHZ 2.8/3.3V	66 MHZ	1-2	1-2	1-2	2-3	2-3	1-2	1-2	1-2	7-8	1-2,3-4,5-6	1-2	3.5X

CYRIX® 6X86 PROCESSOR INSTALLATION

CPU CLOCK	SYS. CLOCK	JP1	JP2	JP3	JP6	JP7	JP8	JP9	JP10	JP17	JP18	JP19	RATIO
166+ M1 3.52V	66 MHZ	2-3	1-2	1-2	2-3	2-3	1-2	1-2	1-2	1-2,3-4,5-6,7-8	OPEN	1-2	2X
6X86L 166 2.8/3.3V	66 MHZ	2-3	1-2	1-2	2-3	2-3	1-2	1-2	1-2	7-8	1-2,3-4,5-6	1-2	2X
6X86L 200 2.8/3.3V	75 MHZ	2-3	1-2	1-2	2-3	2-3	1-2	2-3	1-2	7-8	1-2,3-4,5-6	1-2	2X
6X86MX 166 2.9/3.3V	66 MHZ	2-3	1-2	1-2	2-3	2-3	1-2	1-2	1-2	1-2,7-8	1-2,3-4,5-6	1-2	2X
6X86MX 200 2.9/3.3V	75 MHZ	2-3	1-2	1-2	2-3	2-3	1-2	2-3	1-2	1-2,7-8	1-2,3-4,5-6	1-2	2X
6X86MX 233 2.9/3.3V	75 MHZ	2-3	2-3	1-2	2-3	2-3	1-2	2-3	1-2	1-2, 7-8	1-2,3-4,5-6	1-2	2.5X
6X86MX 266 2.7/3.3V	83 MHZ	2-3	2-3	1-2	1-2	2-3	2-3	2-3	1-2	1-2,3-4,5-6	1-2,3-4,5-6	1-2	2.5X
6X86MII 300 2.9/3.3V	66MHZ	1-2	1-2	1-2	2-3	2-3	1-2	1-2	1-2	1-2, 7-8	1-2,3-4,5-6	1-2	3.5X

AMD® K5/K6/K6-2 PROCESSOR INSTALLATION

CPU CLOCK	SYS. CLOCK	JP1	JP2	JP3	JP6	JP7	JP8	JP9	JP10	JP17	JP18	JP19	RATIO
K5-PR100/PR133 3.52V	66 MHZ	1-2	1-2	1-2	2-3	2-3	1-2	1-2	1-2	1-2,3-4,5-6,7-8	OPEN	1-2	1.5X
K5-PR166 3.52V	66 MHZ	2-3	2-3	1-2	2-3	2-3	1-2	1-2	1-2	1-2,3-4,5-6,7-8	OPEN	1-2	2.5X
K6-PR166 2.9/3.3V	66 MHZ	2-3	2-3	1-2	2-3	2-3	1-2	1-2	1-2	1-2,7-8	1-2,3-4,5-6	1-2	2.5X
K6-PR200 2.9/3.3V	66 MHZ	1-2	2-3	1-2	2-3	2-3	1-2	1-2	1-2	1-2,7-8	1-2,3-4,5-6	1-2	3X
K6-PR233 3.2/3.3V	66 MHZ	1-2	1-2	1-2	2-3	2-3	1-2	1-2	1-2	5-6,7-8	1-2,3-4,5-6	1-2	3.5X
K6-PR233 3.3/3.3V	66 MHZ	1-2	1-2	1-2	2-3	2-3	1-2	1-2	1-2	1-2,5-6,7-8	1-2,3-4,5-6	1-2	3.5X
K6-PR266 2.2/3.3V	66 MHZ	2-3	1-2	2-3	2-3	2-3	1-2	1-2	1-2	3-4	1-2,3-4,5-6	1-2	4X
K6-PR300 2.2/3.45V	66 MHZ	2-3	2-3	2-3	2-3	2-3	1-2	1-2	1-2	3-4	1-2,3-4,5-6	2-3	4.5X
K6-2 266 2.2V/3.3V	66 MHZ	2-3	1-2	2-3	2-3	2-3	1-2	1-2	1-2	3-4	1-2,3-4,5-6	1-2	4X
K6-2 300 2.2V/3.3V	100MHZ	1-2	2-3	1-2	1-2	2-3	1-2	1-2	2-3	3-4	1-2,3-4,5-6	1-2	3X
K6-2 333 2.2V/3.3V	95 MHZ	1-2	1-2	1-2	1-2	2-3	2-3	1-2	2-3	3-4	1-2,3-4,5-6	1-2	3.5X
K6-2 350 2.2V/3.3V	100MHZ	1-2	1-2	1-2	1-2	2-3	1-2	1-2	2-3	3-4	1-2,3-4,5-6	1-2	3.5X
K6-2 380 2.2V/3.3V	95 MHZ	2-3	1-2	2-3	1-2	2-3	2-3	1-2	2-3	3-4	1-2,3-4,5-6	1-2	4X
K6-2 400 2.2V/3.3V	100MHZ	2-3	1-2	2-3	1-2	2-3	1-2	1-2	2-3	3-4	1-2,3-4,5-6	1-2	4X

JP1-JP3 - CPU/BUS RATIO

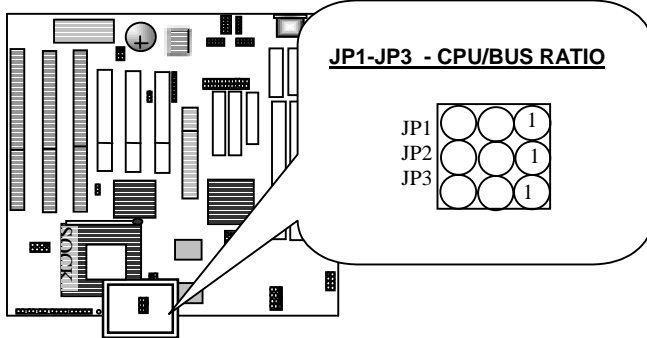

RATIO	JP1	JP2	JP3	RATIO	JP1	JP2	JP3	RATIO	JP1	JP2	JP3
1.5X 	1-2	1-2	1-2	2X 	2-3	1-2	1-2	4.5X 	2-3	2-3	2-3
2.5X 	2-3	2-3	1-2	3X 	1-2	2-3	1-2				
3.5X 	1-2	1-2	1-2	4X 	2-3	1-2	2-3				

JP4-JP5: SDRAM CLOCK FREQUENCY

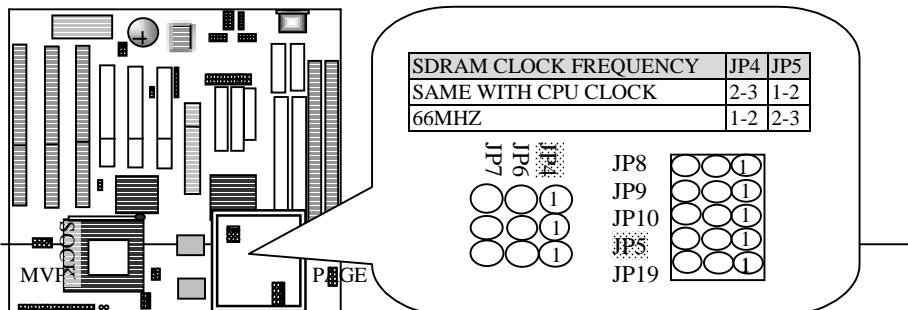



JP6 - JP10 - CPU SPEED SELECTOR

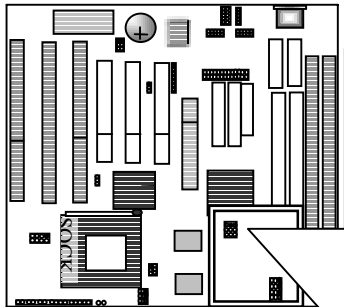

PLEASE NOTE "CPU SPEED SELECTOR" ARE JP6-JP10. JP4 , JP5 & JP19 ARE NOT INCLUDED.

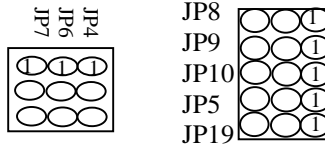

JUMPER	66 MHZ	75 MHZ	83.3 MHZ	95 MHZ	100 MHZ
JP6	2-3	2-3	1-2	1-2	1-2
JP7	2-3	2-3	2-3	2-3	2-3
JP8	1-2	1-2	2-3	2-3	1-2
JP9	1-2	2-3	2-3	1-2	1-2
JP10	1-2	1-2	1-2	2-3	2-3

66MHZ	75MHZ	83.3MHZ
95 MHZ	100 MHZ	

JP11: DIMM VOLTAGE SELECTOR

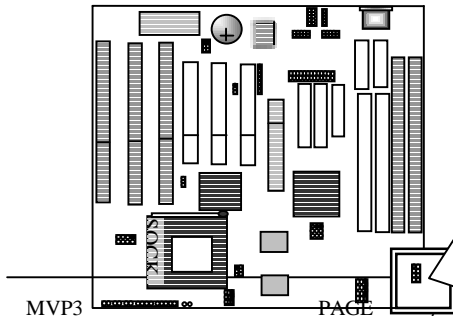

JP11: DIMM VOLTAGE SELECTOR

JP11	DESCRIPTION
1-2, 3-4	5V DIMM
5-6, 7-8	3.3V DIMM

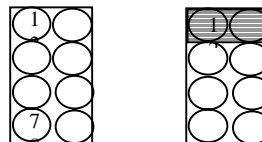

JP12: FLASH ROM VOLTAGE SELECTOR
JP14: CMOS SELECTOR

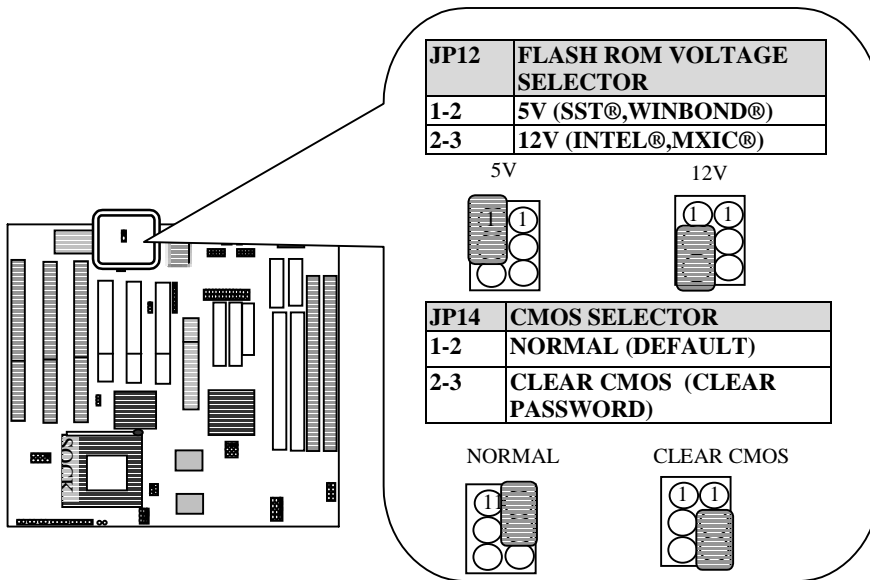

JP18: CPU VOLTAGE CONNECTOR

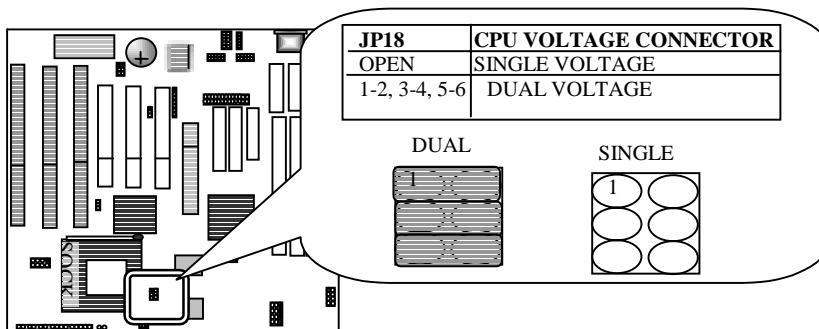

JP17 - CPU VOLTAGE SELECTOR

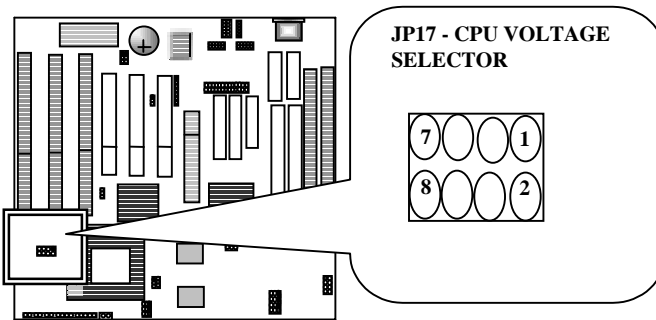

JP17	V _{CORE}	JP17	V _{CORE}
1-2	2.1V 	3-4	2.2V
1-2, 3-4, 5-6	2.7V 	7-8	2.8V
1-2, 7-8	2.9V 	5-6, 7-8	3.2V
1-2, 5-6, 7-8	3.3V 	1-2, 3-4, 5-6, 7-8	3.5V

JP19: CPU TYPE SELECTIOR

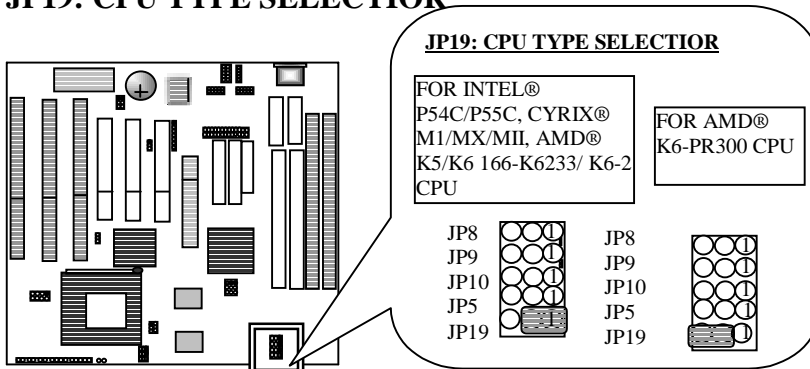

CN3: KB-CONNECTOR

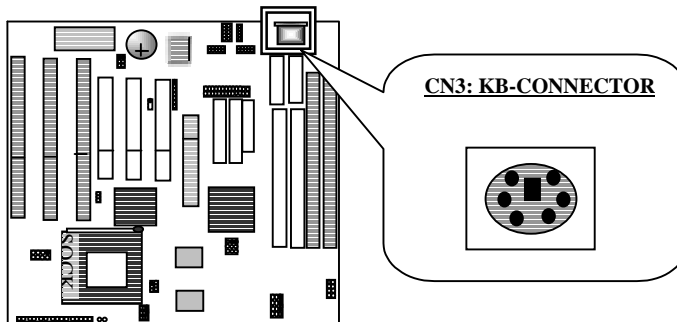

CN8: I.R (INFRA-RED) CONNECTOR

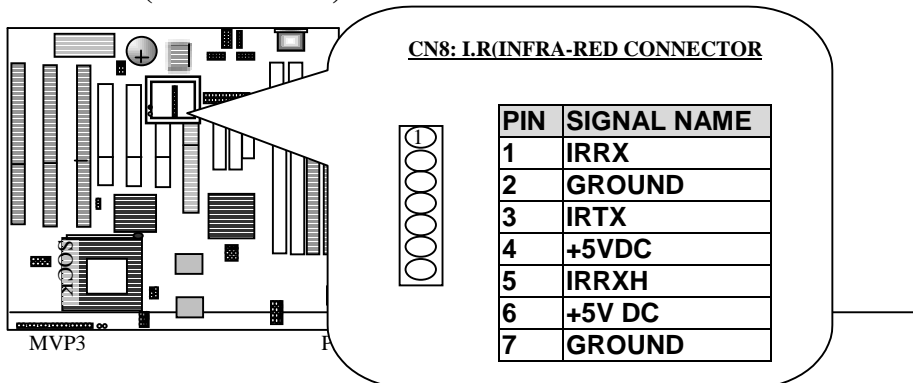

CN9: AT POWER CONNECTOR
CN10: ATX POWER CONNECTOR

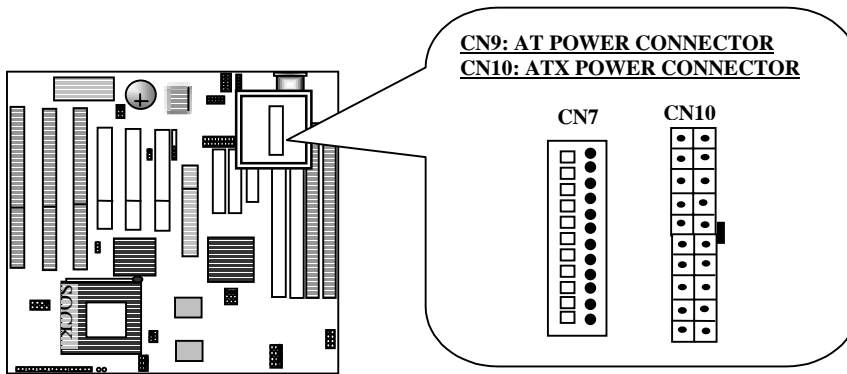

CN9: AT POWER SUPPLY CONNECTOR

PIN	DESCRIPTION	PIN	DESCRIPTION
1	POWER GOOD	7	GROUND
2	+5V DC	8	GROUND
3	+12V DC	9	-5V DC
4	-12V DC	10	+5V DC
5	GROUND	11	+5V DC
6	GROUND	12	+5V DC

CN10- ATX POWER SUPPLY CONNECTOR

PIN	DESCRIPTION	PIN	DESCRIPTION
1	+3.3V DC	11	+3.3V DC
2	+3.3V DC	12	-12V DC
3	GROUND	13	GROUND
4	+5V DC	14	SOFT-POWER
5	+5V DC	15	GROUND
6	+5V DC	16	GROUND
7	GROUND	17	GROUND

8	POWER GOOD	18	-5V DC
9	+5V STANDBY	19	+5V DC
10	+12V DC	20	+5V DC

IDE1: PRIMARY HDD CONNECTOR
IDE2: SECONDARY HDD CONNECTOR
CN7: FLOPPY DISK CONNECTOR

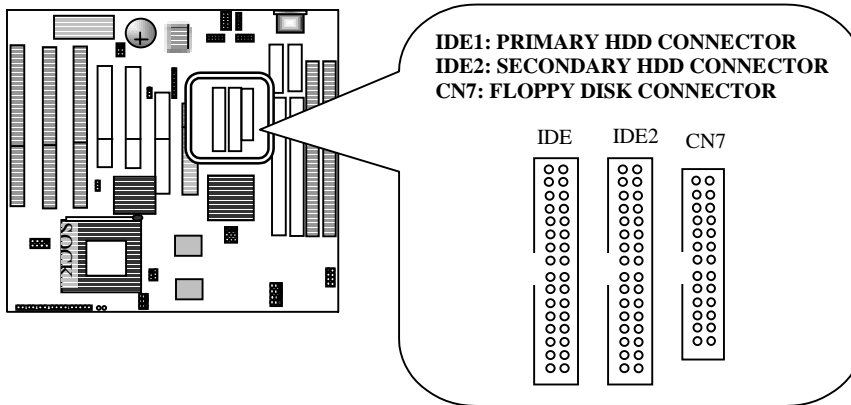

USB: Universal Serial Port Connector

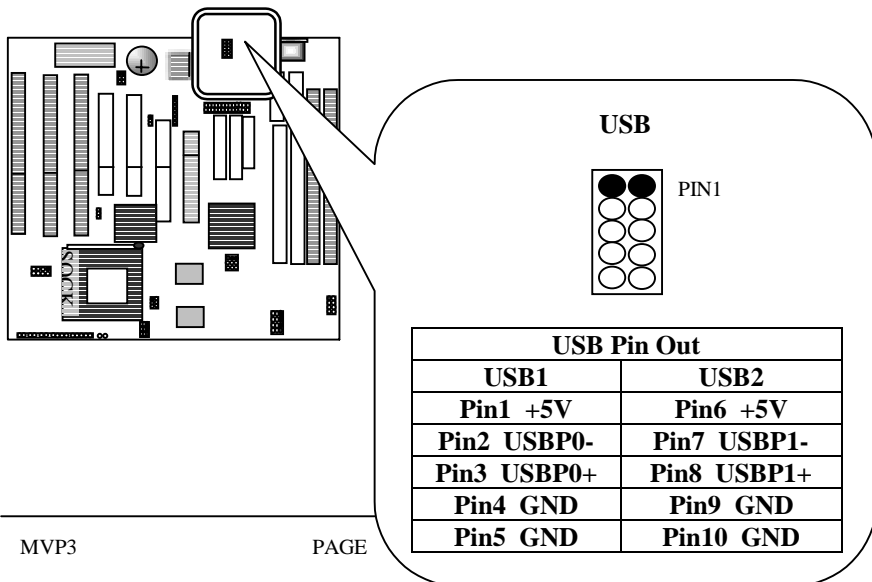

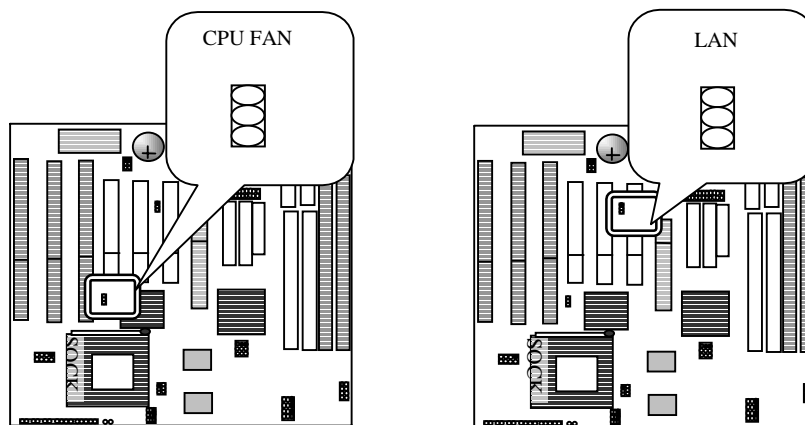

2-3 SIMM INSTALLATION PROCEDURES

THE SIMM MEMORY MODULES WILL ONLY FIT IN ONE ORIENTATION AS SHOWN BECAUSE OF A "PLASTIC SAFETY TAB" ON ONE END OF THE SIMM SLOTS WHICH REQUIRES THE "NOTCHED END" OF THE SIMM MEMORY MODULES.

PRESS THE MEMORY MODULE FIRMLY INTO PLACE STARTING AT A 45 DEGREE ANGLE MAKING SURE THAT ALL THE CONTACTS ARE ALIGNED WITH THE SOCKET.

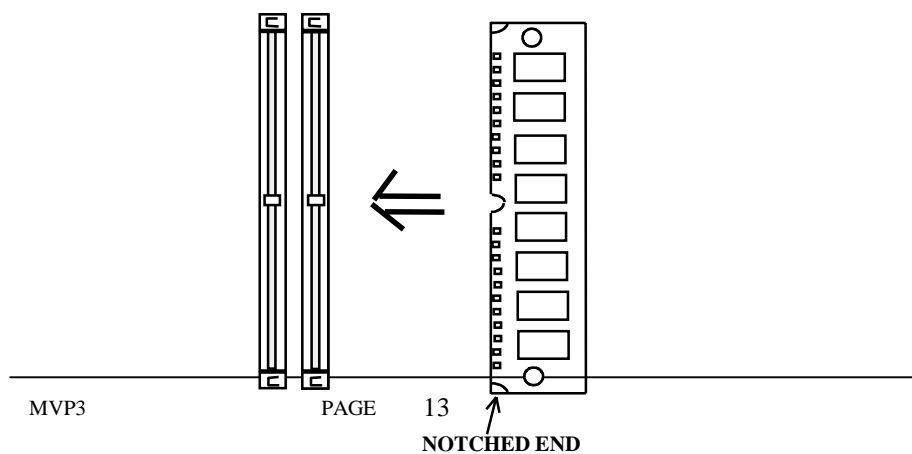

2-4 DIMM INSTALLATION PROCEDURES

INSERT THE MODULE AS SHOWN. DUE TO DIFFERENT NUMBER OF PINS ON EITHER SIDE OF THE BREAKS, THE MODULE WILL ONLY FIT IN THE ORIENTATION AS SHOWN. DRAM SIMM MODULES HAVE THE SAME PIN CONTACT ON BOTH SIDES. SDRAM DIMM MODULES HAVE DIFFERENT PIN CONTACTS ON EACH SIDE AND THEREFORE HAVE A HIGHER PIN DENSITY.

EDO DIMM SUPPORTS EITHER 3.3V OR 5V. PLEASE NOTE ONLY PC-100 100 MHZ DIMM IS REQUIRED WHEN THE SYSTEM IS USING 100 MHZ CPU.

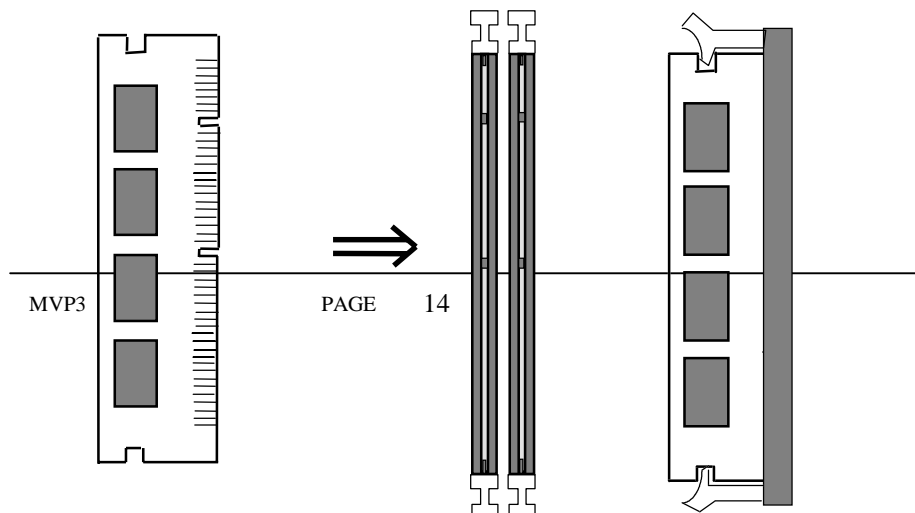

2-5 MEMORY CHART

SYSTEM MEMORY RAM IS COMPRISED OF INDUSTRIAL STANDARD 72-PIN SINGLE IN-LINE MEMORY MODULES (SIMMS). BURST EXTENDED DATA OUT (BEDO) AND EXTENDED DATA OUT (EDO) MEMORY ARE THE LATEST DRAM CHIP DESIGNS THAT PERFORM A LOT BETTER THAN THE FAST PAGE MODE DRAM TYPE. THE **VIA APOLLO M VP3** CHIPSET IS ABLE TO SUPPORT STANDARD FPM (FAST PAGE MODE), EDO (EXTENDED DATA OUT), BEDO (BURST EXTENDED DATA OUT), AND PC-100 100MHZ DIMM. MEMORY CAN BE INSTALLED IN A VARIETY OF CONG., AS SHOW IN THE FOLLOWING TABLE:

TOTAL MEMORY	BANK 0 (DIMM1)	BANK 1 (DIMM2)	BANK2 (SIMM1, SIMM2)
8MB	8MB		
8MB			4MB&4MB
12MB	8MB	4MB	
16MB	8MB	8MB	
16MB			8MB&8MB

24MB	16MB	8MB	
32MB	16MB	16MB	
32MB	32MB		
32MB			16MB&16MB
40MB	32MB	8MB	
48MB	32MB	16MB	
64MB	32MB	32MB	
64MB			32MB&32MB
64MB	64MB		
72MB	64MB	8MB	
80MB	64MB	16MB	
96MB	64MB	32MB	
128MB	64MB	64MB	
128MB			64MB&64MB

CHAPTER 3 BIOS SETUP

AWARD'S ROM BIOS PROVIDES A BUILT-IN SETUP PROGRAM WHICH ALLOWS USER TO MODIFY THE BASIC SYSTEM CONFIGURATION AND HARDWARE PARAMETERS. THE MODIFIED DATA WILL BE STORED IN A BATTERY-BACKED CMOS RAM SO DATA WILL BE RETAINED EVEN WHEN THE POWER IS TURNED OFF. IN GENERAL, THE INFORMATION SAVED IN THE CMOS RAM STAY UNCHANGED UNLESS THERE IS CONFIG. CHANGE IN THE SYSTEM, SUCH AS HARDISK DRIVER REPLACEMENT OR CHANGES OF NEW EQUIPMENT.

IT IS POSSIBLE THAT CMOS HAS A BATTERY FAILURE WHICH CAUSES DATA LOSS IN CMOS RAM. IF SO, RE-ENTERING SYSTEM CONFIG. PARAMETERS BECOMES NECESSARY.

TO ENTER SETUP PROGRAM

POWER ON THE COMPUTER AND PRESS KEY IMMEDIATELY, WHICH BRINGS YOU INTO BIOS CMOS SETUP UTILITY.

THE STANDARD CMOS SETUP SCREEN IS DISPLAYED AS ABOVE. SYSTEM BIOS AUTOMATICALLY DETECTS MEMORY SIZE. NO CHANGES ARE NECESSARY SINCE IT HAS A FEW ITEMS FOR SETTING. EACH ITEM MAY HAVE ONE OR MORE OPTION SETTINGS. IT ALLOWS YOU TO

CHANGE THE SYSTEM DATE AND TIME, IDE HARD DISK, FLOPPY DISK DRIVE TYPES FOR DRIVE A: AND B: BOOT UP VIDEO DISPLAY MODE, AND POST ERROR HANDLING SELECTION. USE THE ARROW KEYS TO HIGHLIGHT THE ITEM AND THEN USE THE <PGUP> OR <PGDN> KEYS TO SELECT THE VALUE YOU WANT IN EACH ITEM.

HARD DISK CONFIGURATIONS

TYPE :

SELECT FROM "1" TO "45" TO FILL IN REMAINING FIELDS WITH REDEFINED VALUES OF DISK DRIVES. SELECT "USER" TO FILL IN THE REMAINING FIELDS. SELECT "AUTO" TO DETECT THE HDD TYPE AUTOMATICALLY.

SIZE :

THE HARD DISK SIZE. THE UNIT IS MEGA BYTE

CYLS :

THE CYLINDER NUMBER OF THE HARD DISK

HEAD :

THE READ/WRITE HEAD NUMBER OF HARD DISK. THE RANGE IS FROM "1" TO "16."

PRECCOMP :

THE CYLINDER NUMBER AT WHICH THE DISK DRIVE CHANGES THE WRITTEN TIMING

LANDZ :

THE CYLINDER NUMBER THAT THE DISK DRIVE HEADS (READ/WRITE) ARE SEATED WHEN THE DISK DRIVE IS PARKED

SECTOR :

THE SECTOR NUMBER OF EACH TRACK DEFINED ON THE HARD

DISK. THE RANGE IS FROM "1" TO "64."

MODE :

SELECT "AUTO" TO DETECT THE MODE TYPE AUTOMATICALLY.

IF YOUR HARD DISK SUPPORTS THE LBA MODE, SELECT "LBA" OR "LARGE". HOWEVER, IF YOUR HARD DISK CYLINDER IS MORE THAN 1024 AND DOES NOT SUPPORT THE LBA FUNCTION, YOU HAVE TO SET AT "LARGE". SELECT "NORMAL" IF YOUR HARD DISK SUPPORTING CYLINDER IS BELOW 1024.

3-2 BIOS FEATURES SETUP

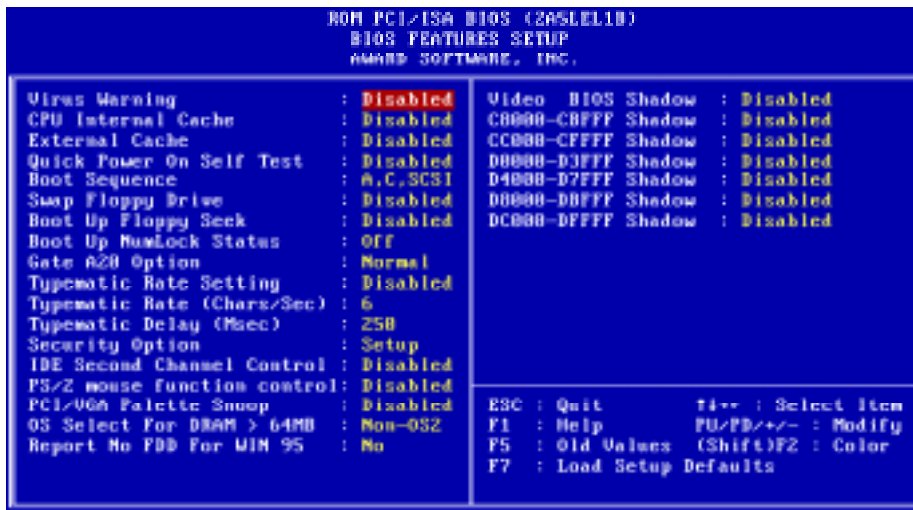

SELECTING THE "BIOS FEATURE SETUP" OPTION IN THE CMOS SETUP UTILITY MENU ALLOWS USE RT O CHANGE SYST EM RE LATED PARAMETERS IN THE DISPLAY MENU. THIS MENU SHOW S ALL OF T HE MANUFACTURER'S DEFAULT VALUES OF SV -P55V. A GAIN, USE R C AN MOVE THE CURSOR B Y P RESSING D IRECTION KEYS AND <PGDN> O R <PGUP> KEY TO MODIFY THE P ARAMETERS. P RESSING [F1] KEY T O DISPLAY HE LP MESS AGE OF T HE SEL ECTED ITEM. THE SETUP

PROGRAM ALSO PROVIDES 2 CONVENIENT WAYS TO LOAD THE DEFAULT PARAMETER DATA FROM CMOS [F7] AREA IF SHOWN DATA IS CORRUPTED. THIS PROVIDES THE SYSTEM WITH A CAPABILITY TO RECOVER FROM ANY POSSIBLE ERROR.

AUTO VIRUS WARNING:

WHEN ENABLED, IT ASSIGNS THE BIOS TO MONITOR THE MASTER BOOT SECTOR AND THE DOS BOOT SECTOR OF THE FIRST HARD DISK DRIVE. THE OPTIONS ARE: **ENABLED, DISABLED (DEFAULT)**.

CPU INTERNAL CACHE:

WHEN ENABLED, IT IMPROVES THE SYSTEM PERFORMANCE. DISABLE THIS ITEM WHEN TESTING OR TROUBLE-SHOOTING. THE OPTIONS ARE: **ENABLED (DEFAULT), DISABLED**

EXTERNAL CACHE:

WHEN ENABLED, IT SUPPORTS AN OPTIONAL CACHE SRAM. THE OPTIONS ARE: **ENABLED (DEFAULT), DISABLED**.

QUICK POWER ON SELF TEST:

WHEN ENABLED, IT ALLOWS THE BIOS TO BYPASS THE EXTENSIVE MEMORY TEST. THE OPTIONS ARE : **ENABLED, DISABLED (DEFAULT)**.

BOOT SEQUENCE:

ALLOWS THE SYSTEM BIOS TO TRY FIRST TO BOOT THE OPERATING SYSTEM FROM THE SELECTED DISK DRIVE. THE OPTIONS ARE : **A, C, SCSI (DEFAULT); C, A, SCSI; C, CDROM, A; CDROM, C, A; D, A, SCSI; E, A, SCSI; F, A, SCSI; SCSI, A, C; SCSI, C, A; C ONLY; LS/ZIP, C.**

SWAP FLOPPY DRIVE:

WHEN ENABLED, IT ALLOWS YOU TO SWITCH THE ORDER IN WHICH THE OPERATING SYSTEM ACCESSES THE FLOPPY DRIVES DURING BOOT UP. THE OPTIONS ARE : **ENABLED, DISABLED (DEFAULT)**

BOOT UP FLOPPY SEEK:

WHEN ENABLED, IT ASSIGNS THE BIOS TO PERFORM FLOPPY DISKETTE DRIVE TESTS BY ISSUING THE TIME-CONSUMING SEEK COMMANDS. THE OPTIONS ARE : **ENABLED (DEFAULT), DISABLED**

BOOT UP NUMLOCK STATUS:

WHEN SET TO ON, IT ALLOWS THE BIOS TO AUTOMATICALLY ENABLE THE NUM LOCK FUNCTION WHEN THE SYSTEM BOOTS UP. THE OPTIONS ARE: **ON (DEFAULT), OFF.**

TYPEMATIC RATE SETTING:

THE TERM "TYPEMATIC" MEANS THAT WHEN A KEYBOARD KEY IS HELD DOWN, THE CHARACTER IS REPEATEDLY ENTERED UNTIL THE KEY IS RELEASED. WHEN THIS ITEM IS ENABLED, YOU MAY CHANGE THE TYPEMATIC REPEAT RATE. THE OPTIONS ARE : **DISABLED (DEFAULT), ENABLED**

TYPEMATIC RATE (CHARS/SEC):

IT SETS THE RATE OF A CHARACTER REPEAT WHEN THE KEY IS HELD DOWN. THE OPTIONS ARE: **6 (DEFAULT), 8, 10, 12, 15, 20, 24, 30.**

TYPEMATIC DELAY (MSEC):

IT SETS THE DELAY TIME BEFORE A CHARACTER IS REPEATED. THE OPTIONS ARE: **250 (DEFAULT), 500, 750, 1000 MILLISECOND.**

SECURITY OPTION:

ALLOWS YOU TO SET THE SECURITY LEVEL OF THE SYSTEM. THE OPTIONS ARE : **SETUP (DEFAULT), SYSTEM.**

PCI/VGA PALETTE SNOOP:

WHEN ENA BLED, IT A LLOWS YOU T O INST ALL AN ENH ANCED GRAPHICS ADAPTER CARD. IF YOUR G RAPHICS ADAPTER CARD DOES NOT SUPP ORT THE PALETTE SNOOP FUNCT ION, PLEASE SET AT DISABLE TO AVOID SYSTEM MALFUNCTION. THE OPTIONS ARE: ENABLED, DISABLED (DEFAULT).

VIDEO BIOS SHADOW:

WHEN ENA BLED, IT A LLOWS T HE B IOS TO COP Y T HE VIDEO ROM CODE OF THE ADD-ON VIDEO C ARDS T O T HE SYST EM MEMORY FOR FASTER ACCESS. T HE OP TIONS ARE : **ENABLED(DEFAULT), DISABLED.**

C8000-CBFF TO DC000-DFFF SHADOW:

WHEN ENABLED, IT ALLOWS THE BIOS TO COPY THE BIOS ROM CODE OF THE ADD-ON CARD TO SYSTEM MEMORY FOR FASTER ACCESS. IT MAY IMPROVE THE PERFORMANCE OF THE A DD-ON C ARD. SOME ADD-ON C ARDS W ILL N OT FUNCT ION P ROPERLY IF IT 'S BIOS ROM CODE IS SHADOWED. TO USE THESE OPTIONS CORRECTLY, YOU NEED TO KNOW THE MEMORY ADDRESS RANGE USED BY THE BIOS ROM OF EACH A DD-ON C ARD. T HE OPTIONS ARE : **ENAB LED, DI SABLED (DEFAULT).**

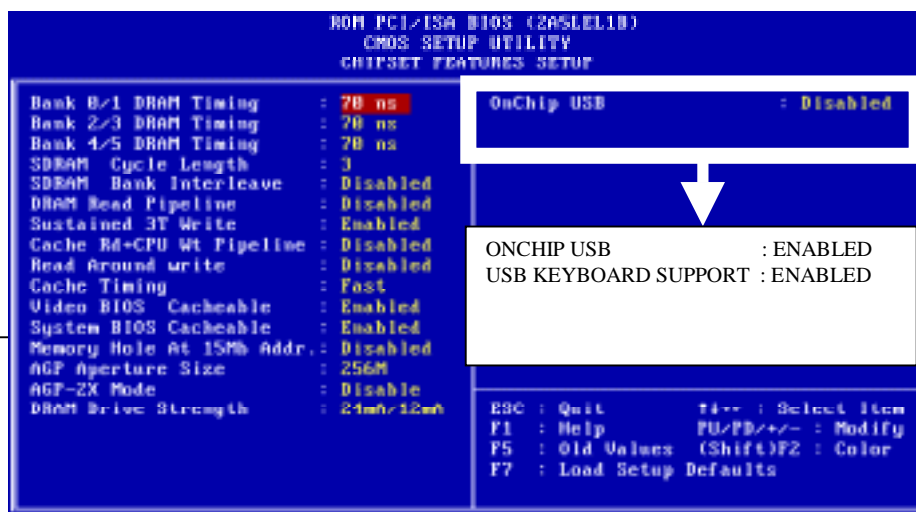
3-3 CHIPSET FEATURES SETUP

ONCHIP USB:

DEFAULT IS DISABLE. IF THE SYSTEM USES RELEVANT **USB DEVICES**, FIRST GO TO **PNP/PCI CONFIGURATION** (REFER TO PAGE 27) AND ENABLE **“ASSIGN IRQ FOR USB.”** THEN COME TO **CHIPSET FEATURES SETUP**, AND CHOOSE **“ENABLE”** IN **“ON CHIP USB.”** THE OTHER LINE **“USB KEYBOARD SUPPORT”** WILL APPEAR AS ABOVE.

VIDEO BIOS CACHEABLE:

WHEN ENABLED, IT ALLOWS THE SYSTEM TO USE THE VIDEO BIOS CODES C0000H-C7FFFH FROM CACHE, INSTEAD OF THE LOWER DRAMS

OR ROMS. VIDEO BIOS MUST BE SHADOWED FIRST. THE OPTIONS ARE: ENABLED (DEFAULT), DISABLED.

SYSTEM BIOS CACHEABLE:

WHEN ENABLED, IT ALLOWS THE ROM AREA E0000H-FFFFFFH TO BE CACHEABLE WHEN CACHE CONTROLLER IS ACTIVATED. THE OPTIONS ARE: ENABLED (DEFAULT), DISABLED.

MEMORY HOLD AT 15MB ADDR.:

WHEN ENABLED, THE MEMORY HOLE AT THE 15MB ADDRESS WILL BE RELOCATED TO THE 15~16MB ADDRESS RANGE OF THE ISA CYCLE WHEN THE PROCESSOR ACCESSES THE 15~16MB ADDRESS AREA. WHEN DISABLED, THE MEMORY HOLE AT THE 15MB ADDRESS WILL BE TREATED AS A DRAM CYCLE WHEN THE PROCESSOR ACCESSES THE 15~16MB ADDRESS. THE OPTIONS ARE: **ENABLED, DISABLED (DEFAULT).**

3-4 POWER MANAGEMENT SETUP



POWER MANAGEMENT:

WHEN ENABLE, IT ALLOWS YOU TO USE POWER MANAGEMENT FEATURES.

PM CONTROL BY APM:

A: SELECTING " NO" ALLOWS THE BIOS TO IGNORE THE APM (ADVANCED POWER MANAGEMENT) SPECIFICATION.

B: SELECTING " YES" ALLOWS THE BIOS TO WAIT FOR APM'S PROMPT BEFORE IT ENTERS **DOZE MODE, STANDBY MODE, OR SUSPEND MODE**. IF APM IS INSTALLED, IT WILL PROMPT BIOS TO SET THE SYSTEM INTO THE POWER SAVING MODE AFTER ALL TASKS ARE DONE.

VIDEO OFF OPTION:

THIS FEATURE PROVIDES THE SELECTIONS OF THE VIDEO DISPLAY POWER SAVING MODE. THE OPTION "**SUSPEND -> OFF**" ALLOWS THE DISPLAY BLANKS IF THE SYSTEM ENTERS SUSPEND MODE. THE OPTION "**ALL MODES -> OFF**" ALLOWS THE VIDEO DISPLAY BLANKS IF THE SYSTEM ENTERS DOZE MODE OR SUSPEND MODE. THE OPTION

"ALWAYS ON" ALLOWS THE VIDEO DISPLAY TO STAY IN STANDBY MODE EVEN THE SYSTEM ENTERS DOZE OR SUSPEND MODE.

VIDEO OFF METHOD:

THE OPTION "V/H SYNC+ BLANK" ALLOWS THE BIOS TO BLANK OFF SCREEN DISPLAY BY TURNING OFF THE V-SYNC SIGNALS SENT FROM ADD-ON VIDEO CARD. "DPMS SUPPORTED" ALLOWS THE BIOS TO BLANK OFF SCREEN DISPLAY BY YOUR ADD-ON VIDEO CARD WHICH SUPPORTS DPMS (DISPLAY POWER MANAGEMENT SIGNALING FUNCTION). "BLANK SCREEN" ALLOWS THE BIOS TO BLANK SCREEN DISPLAY BY TURNING OFF THE RED-GREEN-BLUE SIGNALS.

CONSERVE MODE:

WHEN THE DOZE MODE OF THE SYSTEM BEING HAPPENED, THE DOZE MODE IS HANDLED BY HARDWARE NOT BY SMI FUNCTION.

MODEM USE IRQ:

WHEN THE SYSTEM IS IN GREEN FUNCTION, MODEM WAKES UP THE SYSTEM THROUGH IRQ.

HDD POWER DOWN:

SELECTING "DISABLED" WILL TURN OFF THE HARD DISK DRIVE (HDD) MOTOR. SELECTING "1MIN...15MIN" ALLOWS YOU TO DEFINE THE HDD IDLE TIME BEFORE THE HDD ENTERS POWER SAVING MODE. THE OPTION "WHEN SUSPEND" LETS THE BIOS TURN THE HDD MOTOR OFF WHEN THE SYSTEM IS IN SUSPEND MODE. THE OPTIONS "1MIN...15MIN" AND "WHEN SUSPEND" WILL NOT WORK CONCURRENTLY. WHEN HDD IS IN POWER SAVING MODE, ANY ACCESS TO THE HDD WILL WAKE THE HDD UP.

DOZE MODE:

WHEN DISABLED, THE SYSTEM WILL NOT ENTER DOZE MODE. THE SPECIFIED TIME OPTION DEFINE THE IDLE TIME THE SYSTEM TAKES BEFORE IT ENTERS DOZE MODE.

SUSPEND MODE:

WHEN DISABLED, THE SYSTEM WILL NOT ENTER SUSPEND MODE. THE SPECIFIED TIME OPTION DEFINES THE IDLE TIME THE SYSTEM TAKES BEFORE IT ENTERS SUSPEND MODE.

VGA:

A: SELECTING "ON" WILL ENABLE THE POWER MANAGEMENT TIMERS WHEN A "NO ACTIVITY" EVENTS IS DETECTED IN THE VGA.
B:SELECTING " OFF" TO DISA BLE T HE P M TIMER EVEN IF A "NO ACTIVITY" EVENT IS DETECTED.

LPT & COM:

A: SELECTING "LPT & COM" WILL ENABLE THE POWER MANAGEMENT TIMERS WHEN A "NO ACTIVITY" EVENT IS DET ECTED IN T HE LPT AND COM PORTS.
B: SEL ECTING " LPT"("COM")W ILLE NABLE THE POWER MANAGEMENT TIMERS W HEN A "NO ACTIVITY" EVENT IS DETECTED IN THE LPT (COM) PORTS.
C: SE LECTING " NONE" TO DISABLE THE P M TIMER EVEN IF A " NO ACTIVITY" EVENT IS DETECTED.

HDD & FDD:

A: SELECTING "ON" WILL ENABLE THE POWER MANAGEMENT TIMERS WHEN A "NO AC TIVITY" EVENT IS DET ECTED IN THE HA RD DISK DRIVE AND FLOPPY DISK DRIVE.
B: SELECTING " OFF" TO DISA BLE T HE P M TIMER EVENT IF A " NO ACTIVITY" EVENT IS DETECTED.

DMA/MASTER:

WHEN THE MA STER IS WOR KING, T HE SYSTEM WILL NOT HAVE SMI SIGNAL UNTIL THE MASTER IS FINISHED.

PRIMARY INTR:

WHEN ENABLED, YOU CAN CHOOSE ANY IRQ#.

IRQ#:

WHEN SET AT "**PRIMARY**" THE PROCESSOR WILL POWER DOWN ONLY AFTER THE BIOS DETECTS A "NO IRQ ACTIVITY" DURING THE TIME SPECIFIED BY THE SUSPEND TIME. IF SET AT "**SECONDARY EVENT**" THE SYSTEM WILL DISTINGUISH WHETHER AN INTERRUPT ACCESSES AN I/O ADDRESS OR NOT. IF IT DOES, THE SYSTEM ENTERS THE STANDBY MODE. IF NOT, THE SYSTEM ENTERS THE DREAMING MODE; THAT IS THE SYSTEM GOES BACK FULL-ON STATUS BUT LEAVES THE MONITOR BLANK. FOR INSTANCE, IF THE SYSTEM CONNECTS TO A LAN AND RECEIVES AN INTERRUPT FROM ITS FILE SERVER, THE SYSTEM WILL ENTER THE DREAMING MODE TO EXECUTE THE CORRESPONDING CALLING ROUTINE.

3-5 PNP/PCI CONFIGURATION

```

ROM PCI/ISA BIOS (ASLE1B)
PNP/PCI CONFIGURATION
AWARD SOFTWARE, INC.

PNP OS Installed      : No
Resources Controlled By : Manual
Reset Configuration Data : Disabled
ACPI I/O Device Mode  : Disabled
IRQ-3 assigned to    : Legacy ISA
IRQ-4 assigned to    : Legacy ISA
IRQ-5 assigned to    : PCI/ISA PaP
IRQ-7 assigned to    : Legacy ISA
IRQ-9 assigned to    : PCI/ISA PaP
IRQ-10 assigned to   : PCI/ISA PaP
IRQ-11 assigned to   : PCI/ISA PaP
IRQ-12 assigned to   : PCI/ISA PaP
IRQ-14 assigned to   : Legacy ISA
IRQ-15 assigned to   : Legacy ISA
DMA-0 assigned to    : PCI/ISA PaP
DMA-1 assigned to    : PCI/ISA PaP
DMA-3 assigned to    : PCI/ISA PaP
DMA-5 assigned to    : PCI/ISA PaP
DMA-6 assigned to    : PCI/ISA PaP
DMA-7 assigned to    : PCI/ISA PaP

CPU to PCI Write Buffer : Enabled
PCI Dynamic Bursting   : Enabled
PCI Master 0 WS Write  : Enabled
PCI Delay Transaction  : Enabled
PCI Master Read Prefetch : Enabled
PCI#2 Access #1 Retry  : Disabled
AGP Master 1 WS Write  : Enabled
AGP Master 1 WS Read   : Disabled

PCI IRQ Activated By : Level
Assign IRQ For USB   : Disabled
Assign IRQ For VGA   : Enabled

ESC : Quit      F4++ : Select Item
F1  : Help      F0/PB/+/- : Modify
F5  : Old Values (Shift)F2 : Color
F7  : Load Setup Defaults

```

PCI IRQ ACTIVED BY:

IF YOUR IDE CARDS IS TRIGGERED BY EDGE, SET IT AT "EDGE". THE OPTIONS ARE: LEVEL, EDGE (DEFAULT).

PCI IDE IRQ MAP TO:

SET TO AUTO TO ALLOW THE SYSTEM BIOS TO AUTOMATICALLY DETECT WHICH INTERRUPT IS USED BY THE PCI MASTER DRIVE. THE OPTIONS ARE: PCI-AUTO (DEFAULT), PCI-SLOT1, PCI-SLOT2, PCI-SLOT3, PCI-SLOT4, ISA.

CPU TO PCI WRITE BUFFER:

WHEN ENABLED, IT ALLOWS DATA AND ADDRESS ACCESS TO THE INTERNAL BUFFER OF 82C586B, SO THE PROCESSOR CAN BE RELEASED FROM THE WAITING STATE. THE OPTIONS ARE: ENABLED (DEFAULT), DISABLED.

PCI DYNAMIC BURSTING:

WHEN ENABLED, THE PCI CONTROLLER ALLOWS BURSTING PCI TO TRANSFER IF THE CONSECUTIVE PCI CYCLES COME WITH THE ADDRESS FALLING IN THE SAME 1KB SPACE. THIS IMPROVES THE PCI BUS THROUGH-PUT. THE OPTIONS ARE: ENABLED (DEFAULT), DISABLED.

PCI MASTER 0 WS WRITE:

WHEN ENABLED, IT ALLOWS A ZERO-WAIT-STATE-CYCLE DELAY WHEN THE PCI MASTER DRIVE WRITES DATA INTO DRAM. THE OPTIONS ARE: ENABLED, DISABLED (DEFAULT).

ASSIGN IRQ FOR USB & ASSIGN IRQ FOR VGA

DEFAULT VALUE FOR “ASSIGN IRQ FOR USB” IS DISABLE AND “ASSIGN IRQ FOR VGA” ENABLE. FOR VGA CARDS OF GOOD QUALITY, IRQ ADDRESS IS REQUIRED, BUT FOR SOME LOW-END VGA CARDS, NO IRQ IS NEEDED. THEREFORE, PLEASE CONSIDER **VGA CARD’S FEATURE BEFORE SETTING “ASSIGN IRQ FOR USB” AND “ASSIGN IRQ FOR VGA.”**

3-6 LOAD SETUP DEFAULTS

SELECTING THIS FIELD LOADS THE FACTORY DEFAULTS FOR BIOS AND CHIPSET FEATURES WHICH THE SYSTEM AUTOMATICALLY DETECTS.

**3-7 INTEGRATED PERIPHERALS**

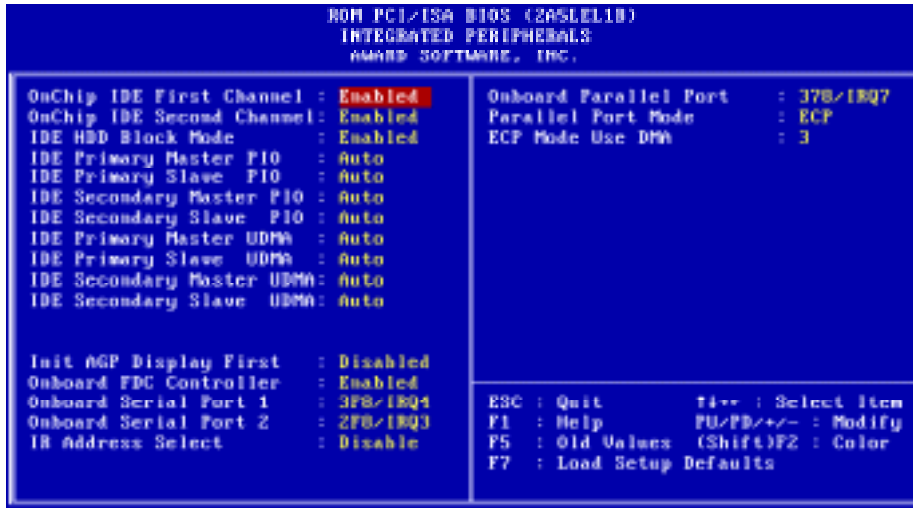
**ONCHIP IDE FIRST CHANNEL:**

WHEN ENABLED, IT ALLOWS THE IDE DRIVER TO USE THE FIRST CHANNEL OF THE PRIMARY IDE.

ONCHIP IDE SECOND CHANNEL:

WHEN ENABLED, IT ALLOWS THE IDE DRIVE TO USE THE SECOND CHANNEL OF THE PRIMARY IDE.

IDE PRIMARY SLAVE PIO:

THE DEFAULT VALUE IS AUTO.

AUTO: BIOS WILL AUTOMATICALLY DETECT THE ONBOARD PRIMARY SLAVE PCI IDE HDD ACCESSING MODE.7

MODE 0-4 : MANUALLY SET THE IDE ACCESSING MODE.

IDE SECONDARY MASTER PIO:

THE DEFAULT VALUE IS AUTO.

AUTO : BIOS WILL AUTOMATICALLY DETECT THE ONBOARD

SECONDARY MASTER PCI IDE HDD ACCESSING MODE.
MODE 0-4 : MANUALLY SETS THE IDE ACCESSING MODE.

IDE PRIMARY MASTER PIO:
THE DEFAULT VALUE IS **AUTO**.

IDE SECONDARY SLAVE PIO:
THE DEFAULT VALUE IS **AUTO**.

ONBOARD FDC CONTROLLER:
THE DEFAULT VALUE IS **ENABLED**.
ENABLED : ENABLED THE ONBOARD I/O CHIP'S FLOPPY DRIVE
INTERFACE CONTROLLER.
DISABLED : DISABLED THE ONBOARD I/O CHIP'S FLOPPY DRIVE
INTERFACE CONTROLLER. WHEN USE ON-CARD
ISA FDC'S CONTROLLER.

ONBOARD SERIAL PORT 1:
THE FIELD ALLOWS THE USER TO SELECT THE SERIAL PORT. THE
DEFAULT VALUE IS **AUTO**.
COM1: ENABLE ONBOARD SERIAL PORT1 AND ADDRESS IS COM1/3F8H
COM2: ENABLE ONBOARD SERIAL PORT1 AND ADDRESS IS COM2/2F8H
COM3: ENABLE ONBOARD SERIAL PORT1 AND ADDRESS IS COM3/3E8H
COM4: ENABLE ONBOARD SERIAL PORT1 AND ADDRESS IS COM4/2E8H
DISABLED: DISABLE ONBOARD I/O CHIP'S SERIAL PORT 1.
AUTO : BIOS WILL AUTOMATICALLY DETECT THE ONBOARD SERIAL
PORT.

ONBOARD SERIAL PORT 2:

THE FIELD ALLOWS THE USER TO SELECT THE SERIAL PORT. THE DEFAULT VALUE IS AUTO.

COM1: ENABLE ONBOARD SERIAL PORT1 AND ADDRESS IS COM1/3F8H

COM2: ENABLE ONBOARD SERIAL PORT1 AND ADDRESS IS COM2/2F8H

COM3: ENABLE ONBOARD SERIAL PORT1 AND ADDRESS IS COM3/3E8H

COM4: ENABLE ONBOARD SERIAL PORT1 AND ADDRESS IS COM4/2E8H

DISABLED: DISABLE ONBOARD I/O CHIP'S SERIAL PORT 1.

AUTO : BIOS WILL AUTOMATICALLY DETECT THE ONBOARD SERIAL PORT.

ONBOARD PARALLEL PORT:

THE FIELD ALLOWS THE USER TO SELECT THE LPT PORT. THE DEFAULT VALUE IS 378H/IRQ7.

378H : ENABLE ONBOARD LPT PORT AND ADDRESS IS 378H AND IRQ7

278H : ENABLE ONBOARD LPT PORT AND ADDRESS IS 278H AND IRQ5

3BCH : ENABLE ONBOARD LPT PORT AND ADDRESS IS 3BCH AND IRQ7

DISABLED : DISABLE ONBOARD I/O CHIP'S LPT PORT



3-8 SUPERVISOR PASSWORD

1. IF CMOS IS CORRUPTED OR THE OPTION IS NOT USED, A DEFAULT PASSWORD STORED IN THE ROM WILL BE USED. THE SCREEN WILL DISPLAY THE FOLLOWING MESSAGE:

**ENTER PASSWORD
PRESS THE [ENTER] KEY TO CONTINUE AFTER
PROPER PASSWORD IS GIVEN.**

2. IF CMOS IS CORRUPTED OR THE OPTION IS USED EARLIER, BUT THE USER WISHES TO CHANGE DEFAULT PASSWORD, THE SET UP UTILITY WILL DISPLAY A MESSAGE AND ASK FOR A CONFIRMATION.

CONFIRM PASSWORD:

3. AFTER PRESSING THE [ENTER] KEY (ROM PASSWORD IF THE OPTION WAS NOT USED) OR CURRENT PASSWORD (USER-DEFINED PASSWORD), THE USER CAN CHANGE THE PASSWORD AND STORE NEW ONE IN CMOS RAM. A MAXIMUM OF 8 CHARACTERS CAN BE ENTERED.

3-9 IDE HDD AUTO DETECTION

THE "IDE HDD AUTO DETECTION" UTILITY IS A VERY USEFUL TOOL ESPECIALLY WHEN YOU DO NOT KNOW WHICH KIND OF HARD DISK TYPE YOU ARE USING. YOU CAN USE THIS UTILITY TO DETECT THE CORRECT DISK TYPE INSTALLED IN THE SYSTEM AUTOMATICALLY. YET, NOW YOU CAN SET HARD DISK TYPE TO AUTO IN THE STANDARD CMOS SETUP. YOU DON'T NEED THE "IDE HDD AUTO DETECTION" UTILITY. THE BIOS WILL AUTO-DETECT THE HARD DISK SIZE AND MODEL ON DISPLAY DURING POST.

ROM PCI/ISA BIOS (2A5LEL19) CMOS SETUP UTILITY AWARD SOFTWARE, INC.							
HARD DISK TYPE	SIZE	CYLS	HEADS	PRECOMP	LANDZONE	SECTORS	MODE
PRIMARY MASTER	343	665	16	65535	664	63	NORMAL
PRIMARY SLAVE							
SECONDARY MASTER							
SECONDARY SLAVE							

NOTE: HDD MODES

THE AWARD BIOS SUPPORTS 3 HDD MODES: NORMAL, LBA&LARGE.

NORMAL MODE:

GENERIC ACCESS MODE EITHER IN BIOS OR IDE CONTROLLER WILL MAKE ANY TRANSFORMATION DURING ACCESSING. THE MAXIMUM NUMBER OF CYLINDERS, HEAD & SECTORS FOR NORMAL MODE ARE 1024, 16 & 63.

NO.CYLINDER (1024)
 X NO.HEAD (16)
 X NO.SECTOR (63)
 X NO.PER SECTOR (512)

528 MEGABYTES

IF USER SETS IN NORMAL MODE, THE MAXIMUM ACCESSIBLE HDD SIZE WILL BE 528 MEGA BYTE EVEN THOUGH ITS PHYSICAL SIZE MAY BE GREATER THAN THAT !

LBA (LOGICAL BLOCK ADDRESSING) MODE:

A NEW HDD ACCESSING METHOD TO OVERCOME THE 528 MEGABYTE BOTTLENECK. THE NUMBER OF CYLINDERS, HEAD & SECTORS SHOWN IN SETUP MAY NOT BE THE NUMBER PHYSICALLY CONTAINED IN THE HDD. DURING HDD ACCESSING, THE IDE CONTROLLER WILL TRANSFORM THE LOGIC ADDRESS DESCRIBED BY SECTOR, HEAD & CYLINDER INTO ITS OWN PHYSICAL ADDRESS INSIDE THE HDD. THE MAXIMUM HDD SIZE SUPPORTED BY LBA MODE IS 8.4 GIGABYTES WHICH IS OBTAINED BY THE FOLLOWING FORMULA:

NO.CYLINDER (1024)
 X NO.HEAD (255)
 X NO.SECTOR (63)
 X BYTES.PER SECTOR (512)

8.4 GIGABYTES

LARGE MODE:

EXTENDED HDD ACCESS MODE SUPPORTED BY AWARD SOFTWARE. SOME IDE HDDS CONTAIN MORE THAN 1024 CYLINDER WITHOUT LBA

SUPPORT (IN SOME CASES, USE R DOES NOT WANT LBA). THE AWARD BIOS PROVIDES ANOTHER ALTERNATIVE TO SUPPORT THESE KINDS OF LARGE MODE:

<u>CYLS.</u>	<u>HEADS</u>	<u>SECTOR</u>	<u>MODE</u>
1120	16	59	NORMAL
560	32	59	LARGE

BIOS TRICKS DOS (OR OTHER OS) THAT THE NUMBER OF CYLINDERS IS LESS THAN 1024 BY DIVIDING IT INTO 2. AT THE SAME TIME, THE NUMBER OF HEADS IS MULTIPLIED BY 2. REVERSE TRANSFORMATION PROCESS WILL BE MADE INSIDE INT 12H IN ORDER TO ACCESS THE RIGHT HDD ADDRESS THE RIGHT HDD ADDRESS !

NO.CYLINDER (1024)
 X NO.HEAD (32)
 X NO.SECTOR (63)
 X BYTES.PER SECTOR (512)

 1 GIGABYTES

NOTE:

TO SUPPORT LBA OR LARGE MODE OF HDDS, THERE MUST BE SOME SOFTWARES INVOLVED. ALL THESE SOFTWARES ARE LOCATED IN THE AWARD HDD SERVICE ROUTINE (INT 13H). IT MAY FAIL TO ACCESS A HDD WITH LBA (LARGE) MODE SELECTED IF YOU ARE RUNNING UNDER A OPERATIONAL SYSTEM WHICH REPLACES THE WHOLE INT 13H. UNIX OPERATIONAL SYSTEMS DO NOT SUPPORT EITHER OR LARGE AND MUST UTILIZE THE STANDARD MODE. UNIX CAN SUPPORT DRIVES LARGER THAN 528MB.

3-10 SAVE & EXIT SETUP

AFTER YOU HAVE MADE CHANGES UNDER SETUP, PRESS <ESC> TO RETURN TO THE MAIN MENU. MOVE CURSOR TO "SAVE AND EXIT SETUP," OR PRESS "F10" AND THEN PRESS "Y" TO CHANGE THE CMOS SETUP. IF YOU DID NOT CHANGE ANYTHING, PRESS <ESC> AGAIN OR MOVE CURSOR TO "EXIT WITHOUT SAVING" AND PRESS "Y" TO RETAIN THE SETUP SETTINGS. THE FOLLOWING MESSAGE WILL APPEAR AT THE CENTER OF THE SCREEN TO ALLOW YOU TO SAVE DATA TO CMOS AND EXIT THE SETUP UTILITY.

SAVE TO CMOS AND EXIT (Y/N)?

3-11 EXIT WITHOUT SAVING

THE "EXIT WITHOUT SAVING" OPTION WILL BRING YOU BACK TO NORMAL BOOT UP PROCEDURE WITHOUT SAVING ANY INTO CMOS RAM. ALL OF THE OLD DATA IN THE CMOS WILL NOT BE DESTROYED. IF YOU SELECT THIS FEATURE, THE FOLLOWING MESSAGE WILL APPEAR AT THE CENTER OF THE SCREEN TO ALLOW YOU TO EXIT THE SETUP UTILITY WITHOUT SAVING CMOS MODIFICATIONS:

QUIT WITHOUT SAVING(Y/N)?

3-12 I/O & MEMORY MAP

MEMORY MAP

ADDRESS RANGE	SIZE	DESCRIPTION
00000-7FFFF	512K	CONVENTIONAL MEMORY
80000-9FBFF	127K	EXTENDED CONVENTIONAL MEMORY
9FC00-9FFFF	1K	EXTENDED BIOS DATA AREA IF PS/2 MOUSE IS INSTALLED
A0000-C7FFF	160K	AVAILABLE FOR HI DOS MEMORY
C8000-DFFFF	96K	AVAILABLE FOR HI DOS MEMORY AND ADAPTER ROMS
E0000-EEFFF	60K	AVAILABLE FOR UMB
EF000-EFFFF	4K	VIDEO SERVICE ROUTINE FOR MONOCHROME & CGA ADAPTER
F0000-F7FFF	32K	BIOS CMOS SETUP UTILITY
F8000-FCFFF	20K	BIOS RUNTIME SERVICE ROUTINE (2)
FD000-FDFFF	4K	PLUG AND PLAY ESCD DATA AREA
FE000-FFFFF	8K	BIOS RUNTIME SERVICE ROUTINE (1)

I/O MAP

000-01F	DMA CONTROLLER (MASTER)
020-021	INTERRUPT CONTROLLER (MASTER)
022-023	CHIPSET CONTROL REGISTERS. I/O POSTS
040-05F	TIMER CONTROL REGISTERS
060-06F	KEYBOARD INTERFACE CONTROLLER (8042)
070-07F	RTC PORTS & CMOS I/O PORTS
080-09F	DMA REGISTER
0A0-0BF	INTERRUPT CONTROLLER (SLAVE)
0C0-0DF	DMA CONTROLLER (SLAVE)
0F0-0FF	MATH COPROCESSOR
1F0-1FB	HARD DISK CONTROLLER
278-27F	PARALLEL PORT 2
2B0-2DF	GRAPHICS ADAPTER CONTROLLER
2F8-2FF	SERIAL PORT 2
360-36F	NETWORK PORTS
378-37F	PARALLEL PORT 1
3B0-3BF	MONOCHROME & PARALLEL PORT ADAPTER
3C0-3CF	EGA ADAPTER
3D0-CDF	CGA ADAPTER
3F0-3F7	FLOPPY DISK CONTROLLER
3F8-3FF	SERIAL PORT-1

3-13 TIME & DMA CHANNELS MAP

TIME MAP:

TIMER CHANNEL 0 SYSTEM TIMER INTERRUPT
TIMER CHANNEL 1 DRAM REFRESH REQUEST
TIMER CHANNEL 2 SPEAKER TONE GENERATOR

DMA CHANNELS:

DMA CHANNEL 0 AVAILABLE
DMA CHANNEL 1 ONBOARD ECP (OPTION)
DMA CHANNEL 2 FLOPPY DISK (SMC CHIP)
DMA CHANNEL 3 ONBOARD ECP (DEFAULT)
DMA CHANNEL 4 CASCADE FOR DMA CONTROLLER 1
DMA CHANNEL 5 AVAILABLE
DMA CHANNEL 6 AVAILABLE
DMA CHANNEL 7 AVAILABLE

3-14 INTERRUPT MAP

NIMI: NON-MASKABLE INTERRUPT

IRQ(H/W): 0 SYSTEM TIMER INTERRUPT FROM TIMER 0

- 1 KEYBOARD OUTPUT BUFFER FULL
- 2 CASCADE FOR IRQ8-15
- 3 SERIAL PORT2
- 4 SERIAL PORT1
- 5 PARALLEL PORT 2
- 6 FLOPPY DISK (SMC CHIP)
- 7 PARALLEL PORT 1
- 8 RTC CLOCK
- 9 AVAILABLE
- 10 AVAILABLE
- 11 AVAILABLE
- 12 PS/2 MOUSE
- 13 MATH COPROCESSOR
- 14 ONBOARD HARD DISK (IDE1) CHANNEL
- 15 ONBOARD HARD DISK (IDE2) CHANNEL



3-15 RTC & CMOS RAM MAP

RTC & CMOS:00 SECONDS
01 SECOND ALARM
02 MINUTES
03 MINUTES ALARM
04 HOURS
05 HOURS ALARM
06 DAY OF WEEK
07 DAY OF MONTH
08 MONTH
09 YEAR
0A STATUS REGISTER A
0B STATUS REGISTER B
0C STATUS REGISTER C
0D STATUS REGISTER D
0E DIAGNOSTIC STATUS BYTE
0F SHUTDOWN BYTE
10 FLOPPY DISK DRIVE TYPE BYTE
12 HARD DISK TYPE BYTE
13 RESERVE
14 EQUIPMENT TYPE
15 BASE MEMORY LOW BYTE
16 BASE MEMORY HIGH BYTE
17 EXTENSION MEMORY LOW BYTE
18 EXTENSION MEMORY HIGH BYTE
19-2D
2E-2F
30 RESERVED FOR EXTENSION MEMORY LOW BYTE
31 RESERVED FOR EXTENSION MEMORY HIGH BYTE
32 DATE CENTURY BYTE
33 INFORMATION FLAG
34-3F RESERVE
40-7F RESERVED FOR CHIPSET SETTING DATA

3-16 CD DRIVER SETUP AFTER INSTALLATING WINDOWS 98

AFTER SETTING WINDOWS 98, IT IS REQUIRED TO INSTALL DRIVERS FOR 586XIRQ AND VXD-V26 AS BELOW. FIRST, PERFORM "SETUP" IN 586XIRQ, AND THEN FOLLOWS "SETUP" IN VXD-V26.

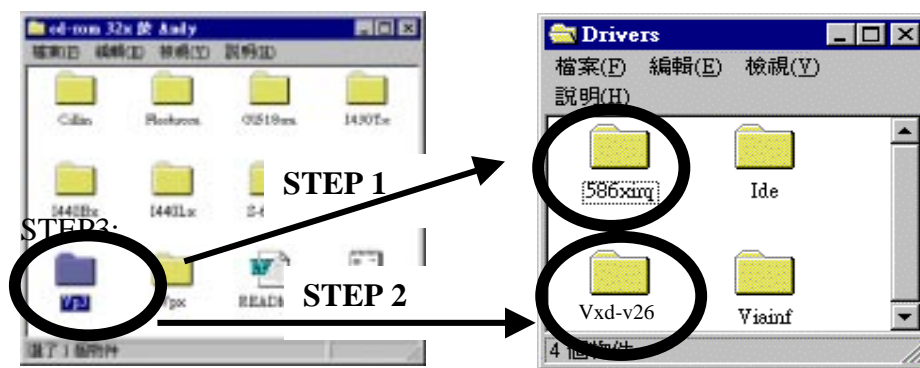

*IF THE CD DRIVER IS BEFORE/INCLUDES VER.1.6, PLEASE DOWNLOAD THE LASTEST VERSION FROM OUR WEBSITE :

WWW.LUCKY-STAR.COM.TW