



SY8009A/SY8009B

High Efficiency 1.5MHz/1MHz, 1.5A/2A Synchronous Step Down Regulator

General Description

The SY8009A and SY8009B are high-efficiency, high frequency synchronous step-down DC-DC regulator ICs capable of delivering up to 1.5A/2A output currents. The SY8009 family operate over a wide input voltage range from 3V to 5.5V and integrate main switch and synchronous switch with very low $R_{DS(ON)}$ to minimize the conduction loss.

Low output voltage ripple and small external inductor and capacitor sizes are achieved with greater than 1MHz switching frequency.

Ordering Information

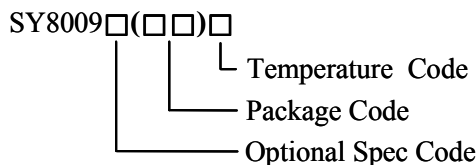

Temperature Range: -40°C to 85°C

Ordering Number	Package type	Note ^①
SY8009AAAC	SOT23-5	1.5A
SY8009BABC	SOT23-6	2A
SY8009BEBC	SSOT23-6	2A

Features

- Low $R_{DS(ON)}$ for internal switches (top/bottom)
 - SY8009A: 180mΩ/120mΩ, 1.5A, SOT23-5
 - SY8009B: 100mΩ/80mΩ, 2.0A, SOT23-6, SSOT23-6
- 3-5.5V input voltage range
- High switching frequency minimizes the external components
 - SY8009A: 1.5MHz
 - SY8009B: 1MHz
- Internal softstart limits the inrush current
- 100% dropout operation
- RoHS Compliant and Halogen Free
- Compact package: SOT23-5, SOT23-6 and Super SOT23-6 are pin-compatible. Other packages are available upon requests

Applications

- LCD TV
- Set Top Box
- Net PC
- Mini-Notebook PC
- Access Point Router

Typical Applications

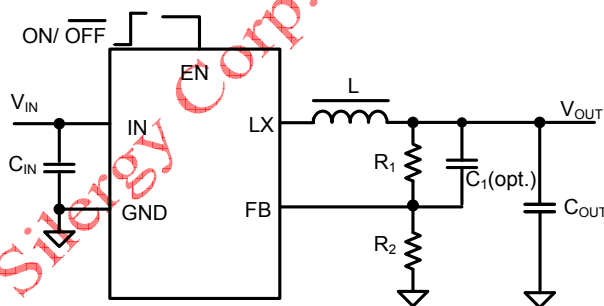

Figure 1. Schematic diagram

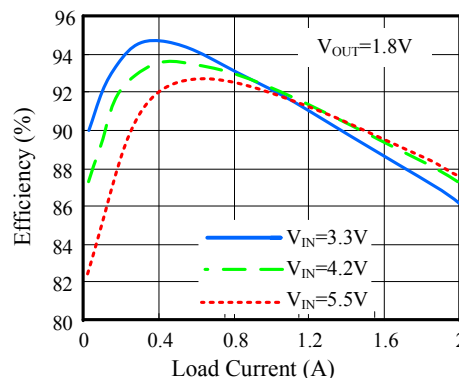
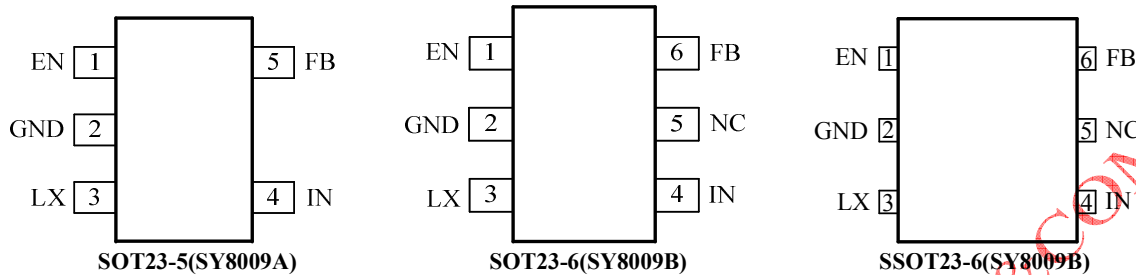

Figure 2. Efficiency vs Load Current



SY8009A/SY8009B

Pinout (top view)



Part Number	Package type	Top Mark ^①
SY8009AAAC	SOT23-5	ADxyz
SY8009BABC	SOT23-6	CUxyz
SY8009BEBC	SSOT23-6	ASxyz

Note ①: x=year code, y=week code, z=lot number code.

Pin Name	Pin Number	Pin Description
EN	1	Enable control. Pull high to turn on. Do not float.
GND	2	Ground pin
LX	3	Inductor pin. Connect this pin to the switching node of inductor.
IN	4	Input pin. Decouple this pin to GND pin with at least 1uF ceramic cap.
FB	6	Output Feedback Pin. Connect this pin to the center point of the output resistor divider (as shown in Figure 1) to program the output voltage: $V_{out}=0.6*(1+R_1/R_2)$

Absolute Maximum Ratings (Note 1)

Supply Input Voltage	6.0V
Enable, FB Voltage	$V_{IN} + 0.6V$
Power Dissipation, P_D @ $T_A = 25^\circ C$, SOT23-5, SOT23-6, SSOT23-6	0.6W
Package Thermal Resistance (Note 2) SOT23-5, SOT23-6, SSOT23-6, θ_{JA}	170°C/W
SOT23-5, SOT23-6, SSOT23-6, θ_{JC}	130°C/W
Junction Temperature Range	-125°C
Lead Temperature (Soldering, 10 sec.)	260°C
Storage Temperature Range	-65°C to 150°C
ESD Susceptibility (Note 2)	
HBM (Human Body Mode)	2kV
MM (Machine Mode)	200V
Dynamic LX voltage in 50ns duration	IN+3V to GND-4V

Recommended Operating Conditions (Note 3)

Supply Input Voltage	3V to 5.5V
Junction Temperature Range	-40°C to 125°C
Ambient Temperature Range	-40°C to 85°C



Electrical Characteristics

($V_{IN} = 5V$, $V_{OUT} = 2.5V$, $L = 2.2\mu H$, $C_{OUT} = 10\mu F$, $T_A = 25^\circ C$, unless otherwise specified)

Parameter	Symbol	Test Conditions	Min	Typ	Max	Unit
Input Voltage Range	V_{IN}		3		5.5	V
Quiescent Current	I_Q	$I_{OUT}=0$, $V_{FB}=V_{REF} \cdot 105\%$		80		μA
Shutdown Current	I_{SHDN}	EN=0		0.1	1	μA
Feedback Reference Voltage	V_{REF}		0.588	0.6	0.612	V
FB Input Current	I_{FB}	$V_{FB}=V_{IN}$	-50		50	nA
PFET RON	$R_{DS(ON),P}$	SY8009A		180		m Ω
		SY8009B		100		m Ω
NFET RON	$R_{DS(ON),N}$	SY8009A		120		m Ω
		SY8009B		80		m Ω
PFET Current Limit	I_{LIM}	SY8009A	1.8			A
		SY8009B	2.5			A
EN rising threshold	V_{ENH}		1.5			V
EN falling threshold	V_{ENL}				0.4	V
Input UVLO threshold	V_{UVLO}				2.7	V
UVLO hysteresis	V_{HYS}			0.1		V
Oscillator Frequency	F_{OSC}	$I_{OUT}=200mA$, SY8009A		1.5		MHz
		$I_{OUT}=500mA$, SY8009B		1		MHz
Min ON Time				50		ns
Max Duty Cycle			100			%
Thermal Shutdown Temperature	T_{SD}			160		$^\circ C$

Note 1: Stresses listed as the above “Absolute Maximum Ratings” may cause permanent damage to the device. These are for stress ratings. Functional operation of the device at these or any other conditions beyond those indicated in the operational sections of the specifications is not implied. Exposure to absolute maximum rating conditions for extended periods may remain possibility to affect device reliability.

Note 2: θ_{JA} is measured in the natural convection at $T_A = 25^\circ C$ on a low effective single layer thermal conductivity test board of JEDEC 51-3 thermal measurement standard. Pin 2 of SOT23-5/SSOT-23-6 packages is the case position for θ_{JC} measurement. Test condition: Device mounted on 2” x 2” FR-4 substrate PCB, 2oz copper, with minimum recommended pad on top layer and thermal vias to bottom layer ground plane

Note 3: The device is not guaranteed to function outside its operating conditions.

SOT23-5 Package outline & PCB layout design

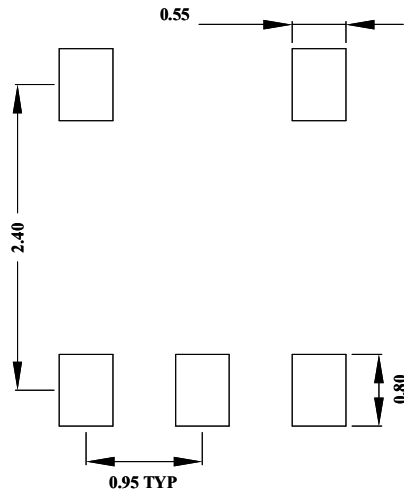

Recommended Pad Layout

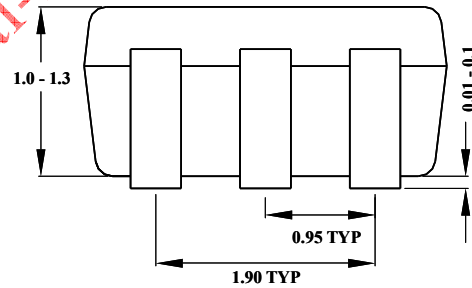
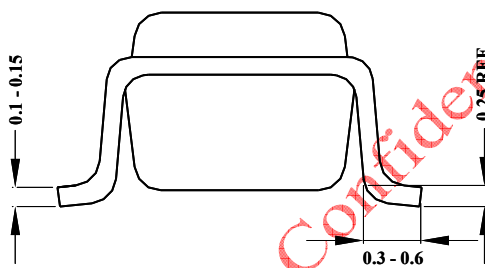
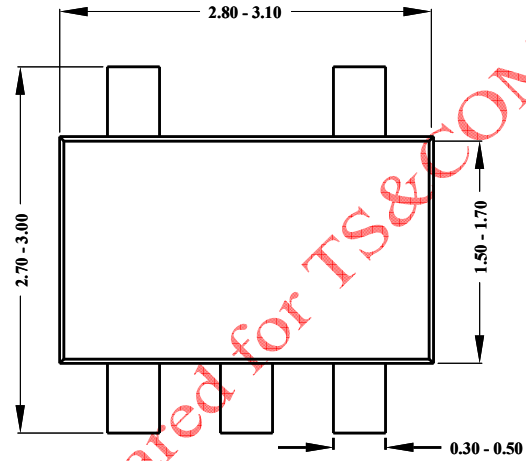

**Notes: All dimensions are in millimeters.
All dimensions don't include mold flash & metal burr.**

SOT23-6 Package outline & PCB layout design

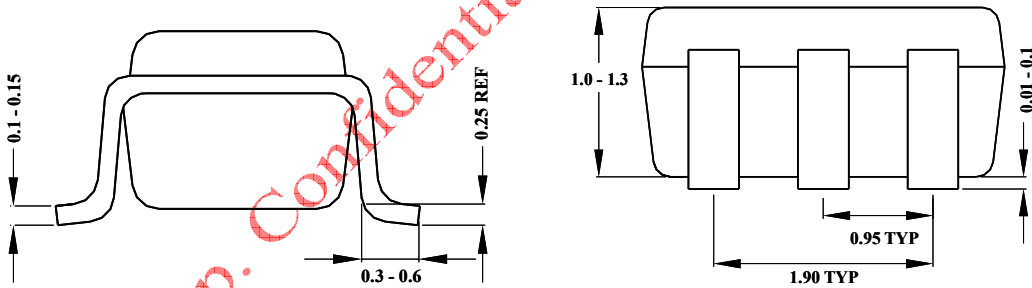
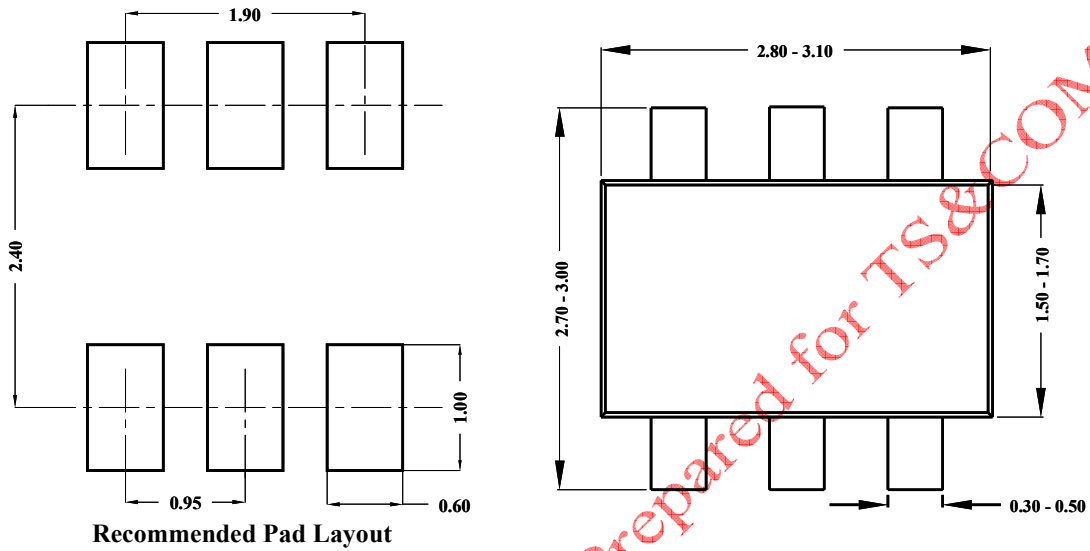

Notes: All dimensions are in millimeters.
All dimensions don't include mold flash & metal burr.

SSOT23-6 Package outline & PCB layout design

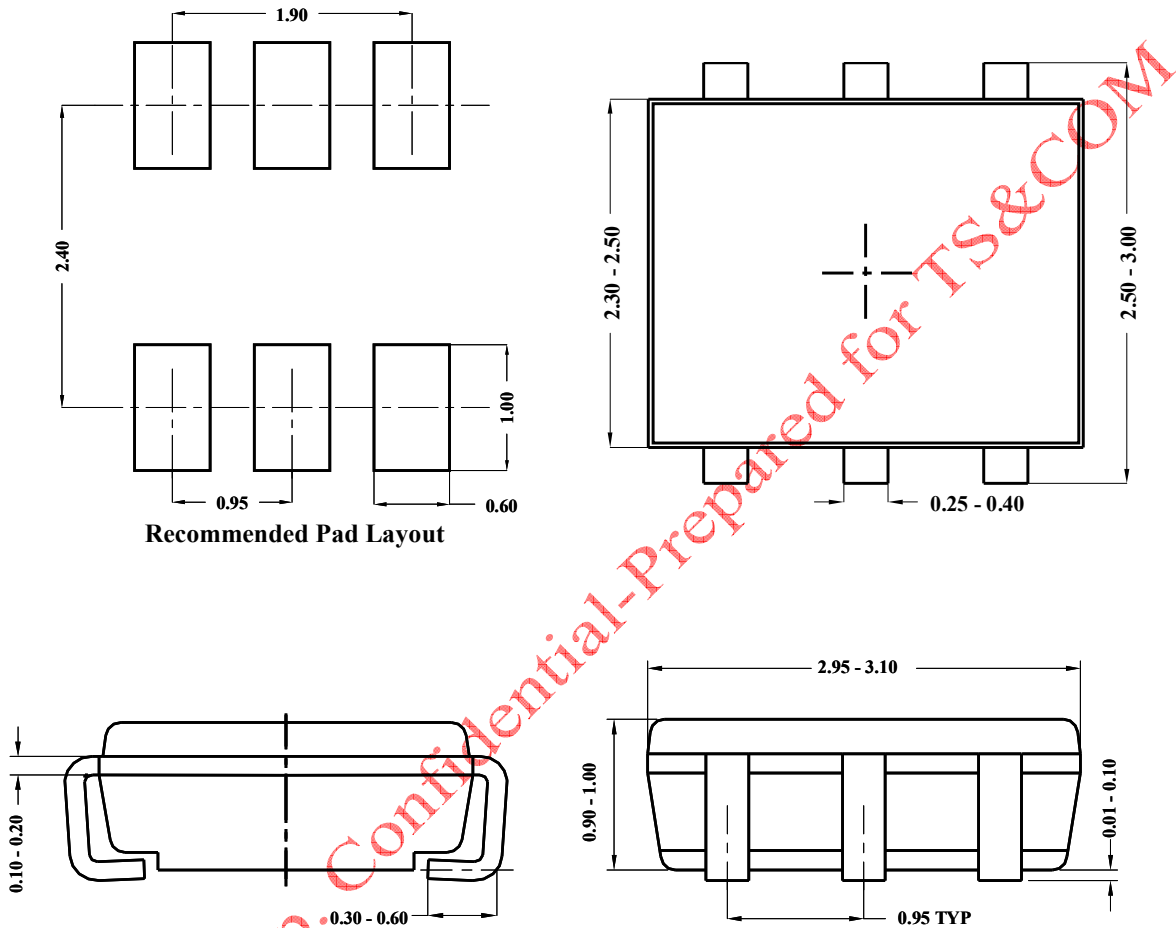

**Notes: All dimensions are in millimeters.
All dimensions don't include mold flash & metal burr.**