



### Product Description

RFMD's RFSW2040D is an absorptive SPST GaAs microwave monolithic integrated circuit (MMIC) switch designed using the RFMD FD05 0.5µm switch process. The RFSW2040D is developed for broadband communications, instrumentation, and electronic warfare.

### Features

- Low Insertion Loss: 1.0dB at 20GHz
- High Isolation: 50dB at 20GHz
- Excellent Return Loss
- 21nS Switching Speed
- GaAs pHEMT Technology

### Applications

- Broadband Communications
- Test Instrumentation
- Fiber Optics
- Military
- Aerospace

#### Optimum Technology Matching® Applied

- GaAs HBT
- GaAs MESFET
- InGaP HBT
- SiGe BiCMOS
- Si BiCMOS
- SiGe HBT
- GaAs pHEMT
- Si CMOS
- Si BJT
- GaN HEMT
- InP HBT
- RF MEMS
- LDMOS

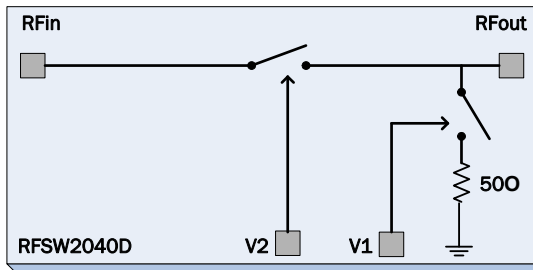

Parameter	Specification			Unit	Condition
	Min.	Typ.	Max.		
Operating Frequency	DC		25	GHz	
Insertion Loss (0GHz to 5GHz)		0.5	0.7	dB	ON State
Insertion Loss (5GHz to 10GHz)		0.7	0.9	dB	ON State
Insertion Loss (10GHz to 15GHz)		0.8	1.1	dB	ON State
Insertion Loss (15GHz to 20GHz)		1.0	1.2	dB	ON State
Insertion Loss (20GHz to 25GHz)		1.2	1.4	dB	ON State
Isolation (DC to 25GHz)	38	43		dB	OFF State
Input Return Loss (DC to 25GHz)	12	17		dB	ON State
Output Return Loss (DC to 25GHz)	13	22		dB	ON State
	3	7		dB	OFF State
IIP3	42	46		dBm	100MHz spacing 2dBm input
IIP2	76	83		dBm	100MHz spacing 2dBm input
Switching Speed		21	28	ns	50% control to 90% RF
Control Current		8	25	uA	Sum of all control lines
Control Voltage	-3	-5	-8	V <sub>DC</sub>	

## Absolute Maximum Ratings

Parameter	Rating	Unit
Drain Bias Voltage ( $V_{CTRL}$ )	-10	V <sub>DC</sub>
RF Input Port Power (Any State)	+30	dBm
RF Output Port Power (ON State only)	+30	dBm
RF Output Port Power (OFF State only)	+21	dBm
Storage Temperature	-40 to +150	°C
Operating Temperature	-40 to +85	°C
ESD JESD22-A114 Human Body Model (HBM)	Class 1A (All Pads)	



**Caution!** ESD sensitive device.

Exceeding any one or a combination of the Absolute Maximum Rating conditions may cause permanent damage to the device. Extended application of Absolute Maximum Rating conditions to the device may reduce device reliability. Specified typical performance or functional operation of the device under Absolute Maximum Rating conditions is not implied.

RoHS status based on EUDirective2002/95/EC (at time of this document revision).

The information in this publication is believed to be accurate and reliable. However, no responsibility is assumed by RF Micro Devices, Inc. ("RFMD") for its use, nor for any infringement of patents, or other rights of third parties, resulting from its use. No license is granted by implication or otherwise under any patent or patent rights of RFMD. RFMD reserves the right to change component circuitry, recommended application circuitry and specifications at any time without prior notice.

## Typical Electrical Performance

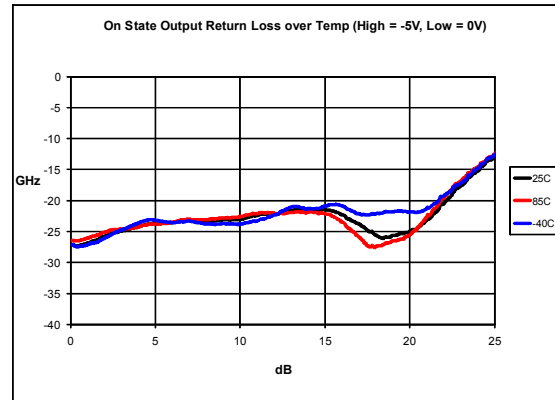
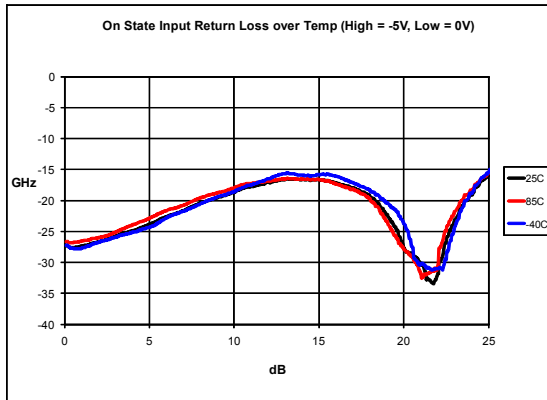
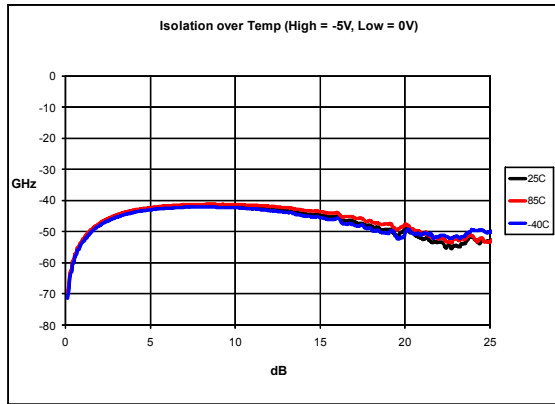
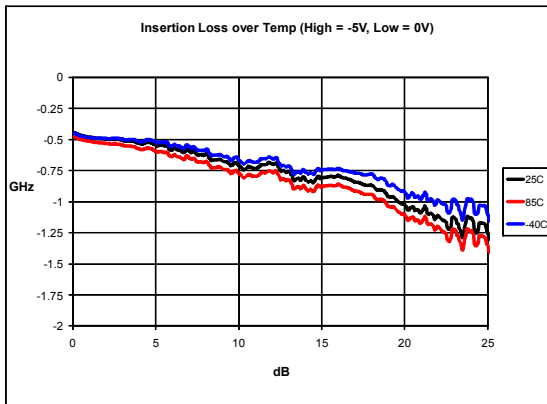

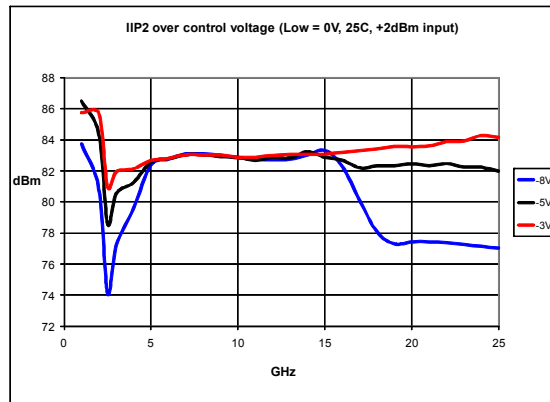
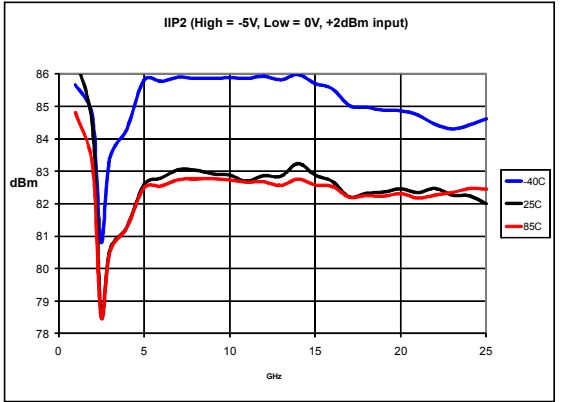
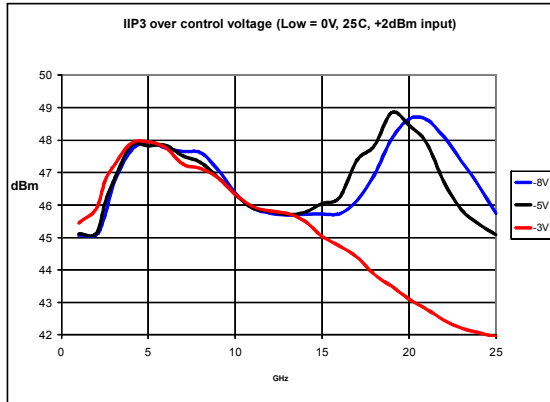
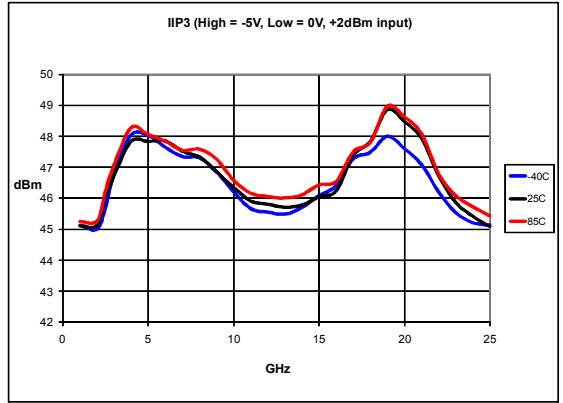
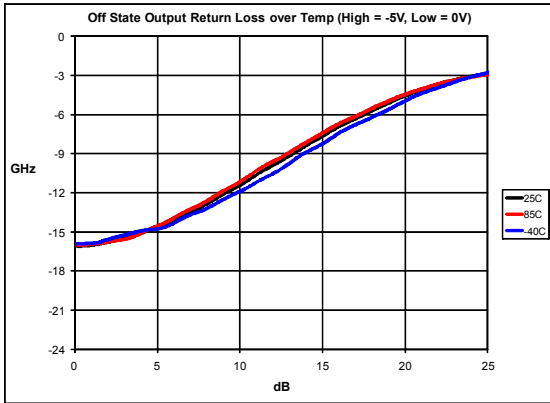

## Die Layout

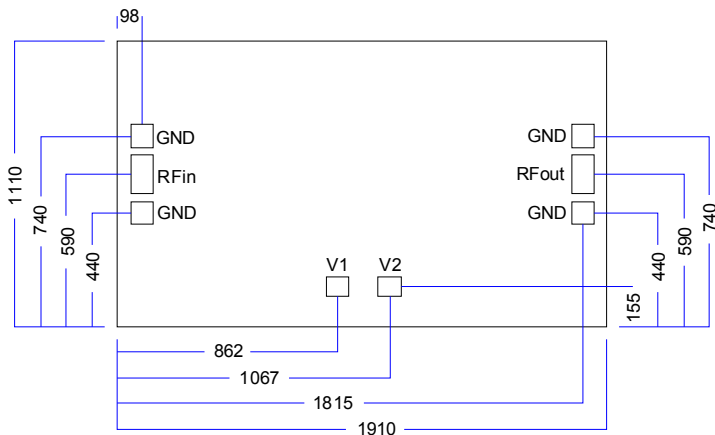

DC and GND bondpads are 88x88um.

RF bondpads are 88x150um.

All units are in um.

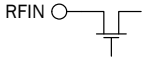
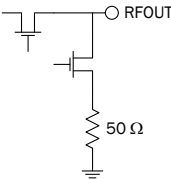
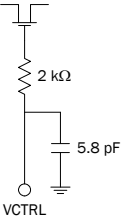
Pin	Function	Description	Interface Schematic
1	<b>RFIN</b>	RF input. This pad is DC coupled and matched to 50Ω from DC to 20GHz. 50Ω microstrip transmission line on 0.127 mm (5mil) thick alumina thin film substrate is recommended.	
2	<b>RFOUT</b>	RF output. This pad is DC coupled and matched to 50Ω from DC to 20GHz. 50Ω microstrip transmission line on 0.127 mm (5mil) thick alumina thin film substrate is recommended.	
3, 4	<b>V1, V2</b>	DC control pad for switch operation. Nominal operating voltage is -5V.	
5	<b>GND</b>	Provides ground path for probe measurements.	

**Truth Table**

Control Line		RF Path
V1	V2	RFIN - RF OUT
High	Low	ON (Low Loss)
Low	High	OFF (High Isolation)

High=-3V to -8V (-5V nominal), Low=0, ±0.2V

**Measurement Technique**

All specifications and typical performances reported in this document were based on data taken with the equipment listed in the stated manner.

Data was taken using a temperature controlled probe station utilizing 150um pitch GSG probes. The probes were placed on a ceramic coplanar to microstrip launch. The launch was then wire bonded to the die using two 1 mil bondwires. The spacing between the launch and the die was 200um, and the bondwire loop height was 100um. the thickness of the test interface was 125um (5mil).

The calibration included the probes and test interfaces, so that the measurement reference plane was at the point of bondwire attachment. Therefore, all data represents the part and accompanying bondwires.

Insertion Loss, Return Loss, and Isolation data were taken using an Agilent E8363B PNA.

IIP3 and IIP2 data were taken utilizing a pair of Agilent E8257D signal generators and an Agilent E4446A PSA.

## Preferred Assembly Instructions

GaAs devices are fragile and should be handled with great care. Specially designed collets should be used where possible. The back of the die is metallized and the recommended mounting method is by the use of conductive epoxy. Epoxy should be applied to the attachment surface uniformly and sparingly to avoid encroachment of epoxy onto the top face of the die. Ideally it should not exceed half the chip height. For automated dispense Ablestick LMISR4 is recommended and for manual dispense Ablestick 84-1 LMI or 84-1 LMIT are recommended. These should be cured at a temperature of 150 °C for one hour in an oven especially set aside for epoxy curing only. If possible the curing oven should be flushed with dry nitrogen. The gold-tin (80% Au 20% Sn) eutectic die attach has a melting point of approximately 280 °C but the absolute temperature being used depends on the leadframe material used and the particular application. The time at maximum temperature should be kept to a minimum. This part has gold (Au) bond pads requiring the use of gold (99.99% pure) bondwire. It is recommended that 25.4um diameter gold wire be used. Recommended lead bond technique is thermocompression wedge bonding with 0.001" (25µm) diameter wire. Bond force, time stage temperature, and ultrasonics are all critical parameters and the settings are dependent on the setup and application being used. Ultrasonic or thermosonic bonding is not recommended. Bonds should be made from the die first and then to the mounting substrate or package. The physical length of the bondwires should be minimized especially when making RF or ground connections.

## Handling Precautions

To avoid damage to the devices, care should be exercised during handling. Proper Electrostatic Discharge (ESD) precautions should be observed at all stages of storage, handling, assembly, and testing.

## ESD/MSL Rating

These devices should be treated as Class 1A (250V to 500V) using the human body model as defined in JEDEC Standard No. 22-A114. Further information on ESD control measures can be found in MIL-STD-1686 and MIL-HDBK-263. This is an unpackaged part and therefore no MSL rating applies.

## Ordering Information

Part Number	Description	Delivery Method	Quantity
RFSW2040DSB	Sample, DC to 25GHz GaAs SPST Switch	Gel Pak	2 pc
RFSW2040DSQ	Small Quantity, DC to 25GHz GaAs SPDT Switch	Gel Pak	25 pc
RFSW2040D	DC to 25GHz GaAs SPDT Switch	Gel Pak	10 pc