



Product Description: P420HW01 V0 TFT-LCD PANEL

AUO Model Name: P420HW01 V0

Customer Part No/Project Name:

Customer Signature	Date	AUO	Date
		Reviewed by : Project Leader / Steven Kuo	-----
		Reviewed by : RD Head / Kelvin Chou	-----
		Prepared By : PM / Eddie Peng	-----
		Reviewed By : PM Head / Michael Goan	-----



*Document Version: 1.0*

*Date:2010/4/06*

## **Product Functional Specification**

**42" Full-HD Color TFT-LCD Module  
Model Name: P420HW01 V0**

**( ) Preliminary Specification  
(\* ) Final Specification**

Note : This specification is subject to change without notice.



## Contents

No	ITEM
	COVER
	CONTENTS
	RECORD OF REVISIONS
1	GENERAL DESCRIPTION
2	ABSOLUTE MAXIMUM RATINGS
3	ELECTRICAL SPECIFICATIONS
3-1	ELECTRICAL CHARACTERISTICS
3-2	INTERFACE CONNECTIONS
3-3	SIGNAL TIMING SPECIFICATIONS
3-4	SIGNAL TIMING WAVEFORMS
3-5	COLOR INPUT DATA REFERENCE
3-6	POWER SEQUENCE
4	OPTICAL SPECIFICATIONS
5	MECHANICAL CHARACTERISTICS
6	RELIABILITY
7	INTERNATIONAL STANDARDS
7-1	SAFETY
7-2	EMC
8	PACKING
9	PRECAUTIONS



## Record of Revision

Version	Date	Page	Old Description	New Description	Remark
0.1	2008/12/8		Preliminary spec first release		
0.2	2009/1/13	4	Outline Dimension 983.0(H)x576.0(V)x52.7(D) mm	Outline Dimension 983.0(H)x576.0(V)x52.5(D) mm	
		6		Add Backlight Power Consumption Values Typ=175	
		8		Add description of pin 6,9,10	
		10		Add item 8~12 for PWM Setting	
		11	Connector1 :S14B-PH-SM3-TB (JST) or equivalent	Connector :S14B-PH-SM4-TB (JST) or equivalent	
		18	IDDB = 6.4A	IDDB = 7.3A.	
		21.22		Modify 2D drawing of back forming	
0.3	2009/3/24	28		Add 9-7 Operating Condition in PID Application	
0.4	2009/4/22	25	3pcs/box	Change to industry packing,7pcs/box	
1.0	2010/4/6	6	Power consumption 175W	Power consumption 180W	
		10	Input current 7.3(typ)	Input current 7.5(typ)	
		10	Input power 175W	Input power 180W	
		11	NO.11 DET	NO.11 Reserved	
		15	t7 500ms	t7 1000ms	
		18	IDDB=7.3A	IDDB=7.5A	
		22		Change drawing	
				Final version.	



## 1. General Description

This specification applies to the 42 inch Color TFT-LCD Module P420HW01 V0. This LCD module has a TFT active matrix type liquid crystal panel 1920x1080 pixels, and diagonal size of 42 inch. This module supports 1920x1080 Full-HD mode (Non-interlace).

Each pixel is divided into Red, Green and Blue sub-pixels or dots which are arranged in vertical stripes. Gray scale or the brightness of the sub-pixel color is determined with a 8-bit gray scale signal for each dot.

The P420HW01 V0 has been designed to apply the 8-bit 2 channel LVDS interface method. It is intended to support displays where high brightness, wide viewing angle, high color saturation, and high color depth.

### \* General Information

Items	Specification	Unit	Note
Active Screen Size	42.02	inches	
Display Area	930.24(H) x 523.26(V)	mm	
Outline Dimension	983.0(H) x 576.0(V) x 52.5(D)	mm	With inverter
Driver Element	a-Si TFT active matrix		
Display Colors	16.7M	Colors	
Number of Pixels	1920 x 1080	Pixel	
Pixel Pitch	0.4845	mm	
Pixel Arrangement	RGB vertical stripe		
Display Mode	Normally Black		
Lamp quantity, type	16pcs, Straight type	pcs	
Surface Treatment	Anti-Glare coating (Haze 11%) Hard coating (3H)		
Display Orientation	Portrait/Landscape enable		



## 2. Absolute Maximum Ratings

The following are maximum values which, if exceeded, may cause faulty operation or damage to the unit.

Item	Symbol	Min	Max	Unit	Note
Power Supply Input Voltage	V <sub>DD</sub>	-0.3	14	[Volt]	1
Logic Input Voltage	V <sub>in</sub>	-0.3	3.6	[Volt]	1
BLU Input Voltage	V <sub>DDB</sub>	-0.3	26.4	[Volt]	1
BLU Brightness Control Voltage	BLON	-0.3	3.6	[Volt]	1
Ambient Operating Temperature	T <sub>OP</sub>	0	+50	[°C]	2
Ambient Operating Humidity	H <sub>OP</sub>	10	80	[%RH]	2
Storage Temperature	T <sub>ST</sub>	-10	+60	[°C]	2
Storage Humidity	H <sub>ST</sub>	10	80	[%RH]	2
Shock (non-operation)		-	50	G	3
Vibration (non-operation)		-	1.5	G	4
Thermal shock		-20	60	C	5

Note 1 : Duration = 50msec

Note 2 : Maximum Wet-Bulb should be 50°C and No condensation.

Note 3 : Half sine wave, shock level : 50G(11ms), direction : ±x, ±y, ±z (one time each direction)

Note 4 : Wave form : Random, vibration level : 1.5G RMS, Bandwidth : 10~500Hz

Duration : X,Y,Z 30min (one time each direction)

Note 5 : -20C/1hr ~ 60C/1hr, 100 cycles

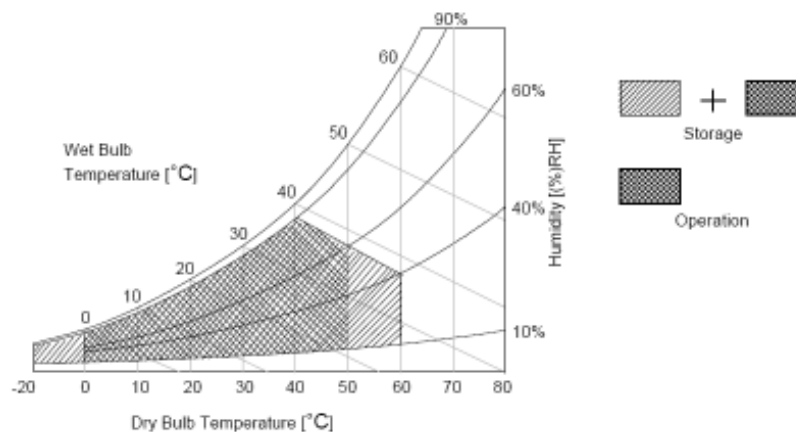



### 3. Electrical Specification

The P420HW01 requires two power inputs. One is employed to power the LCD electronics and to drive the TFT array and liquid crystal. The second input, which powers the CCFL, is typically generated by an inverter.

#### 3-1 Electrical Characteristics

Parameter		Symbol	Values			Unit	Notes
			Min	Typ	Max		
LCD:							
Power Supply Input Voltage		Vdd	10.8	12	13.2	Vdc	
Power Supply Input Current		Idd	-	1		A	1
Power Consumption		Pc	-	12		Watt	1
Inrush Current		I <sub>RUSH</sub>	-	-	4	A	5
LVDS Interface	Differential Input High Threshold Voltage	V <sub>TH</sub>			+100	mV	4
	Differential Input Low Threshold Voltage	V <sub>TL</sub>	-100			mV	4
	Common Input Voltage	V <sub>CIM</sub>	0.6	1.2	1.8	V	
CMOS Interface	Input High Threshold Voltage	V <sub>IH</sub> (High)	2.0		3.3	Vdc	
	Input Low Threshold Voltage	V <sub>IL</sub> (Low)	0		0.8	Vdc	
Backlight Power Consumption				180		Watt	2
Life Time			50,000	60,000		Hours	3

The performance of the Lamp in LCM, for example life time or brightness, is extremely influenced by the characteristics of the DC-AC Inverter. So all the parameters of an inverter should be carefully designed so as not to produce too much leakage current from high-voltage output of the inverter. When you design or order the inverter, please make sure unwanted lighting caused by the mismatch of the lamp and the inverter (no lighting, flicker, etc) never occurs. When you confirm it, the LCD Assembly should be operated in the same condition as installed in your instrument.

Do not attach a conducting tape to lamp connecting wire. If the lamp wire attach to conducting tape, TFT-LCD Module have a low luminance and the inverter has abnormal action because leakage current occurs between lamp wire and conducting tape.

The relative humidity must not exceed 80% non-condensing at temperatures of 40°C or less. At temperatures greater than 40°C, the wet bulb temperature must not exceed 39°C. When operate at low temperatures, the brightness of CCFL will drop and the lifetime of CCFL will be reduced.

**Note :**

1. Vdd=12.0V, fv=60Hz, f<sub>CLK</sub>=80 Mhz , 25°C, Vdd Duration time= 470 μs , Test pattern : white pattern
2. The Backlight power consumption shown above does include loss of external inverter at 25°C. The used lamp current is the lamp typical current
3. The life is determined as the time at which luminance of the lamp is 50% compared to that of initial value at the typical lamp current on condition of continuous operating at 25±2°C.
4. VCIM = 1.2V

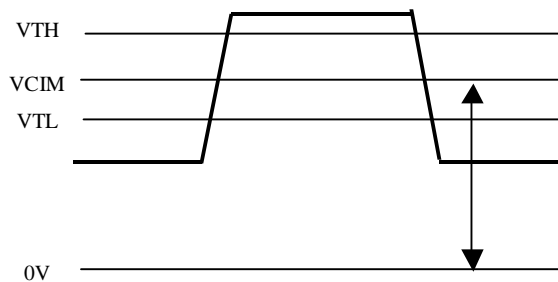

**Figure : LVDS Differential Voltage**

5. Measurement Condition: Rising time = 470 μs

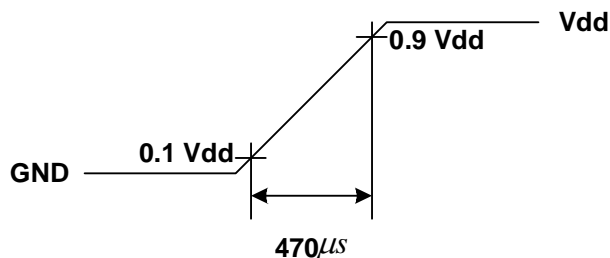





### 3-2 Interface Connections

- LCD connector: P-TWO 187059-5122 which is compatible FI-RE51S-HF (JAE)

No	Symbol	Description	No	Symbol	Description
1	GND	Ground	27	GND	Ground
2	NC	No connection	28	RE_0N	SECOND CHANNEL 0-
3	NC	No connection	29	RE_0P	SECOND CHANNEL 0+
4	NC	No connection	30	RE_1N	SECOND CHANNEL 1-
5	NC	No connection	31	RE_1P	SECOND CHANNEL 1+
6	Reserved	AUO Internal test (open or low)	32	RE_2N	SECOND CHANNEL 2-
7	LVDS SEL	LVDS Order	33	RE_2P	SECOND CHANNEL 2+
8	NC	No connection	34	GND	Ground
9	Reserved	Open or high	35	RE_CLKN	SECOND CLOCK CHANNEL C-
10	Reserved	Open or high	36	RE_CLKP	SECOND CLOCK CHANNEL C+
11	GND	Ground	37	GND	Ground
12	RO_0N	FIRST CHANNEL 0-	38	RE_3N	SECOND CHANNEL 3-
13	RO_0P	FIRST CHANNEL 0+	39	RE_3P	SECOND CHANNEL 3+
14	RO_1N	FIRST CHANNEL 1-	40	NC	No connection
15	RO_1P	FIRST CHANNEL 1+	41	NC	No connection
16	RO_2N	FIRST CHANNEL 2-	42	GND	Ground
17	RO_2P	FIRST CHANNEL 2+	43	GND	Ground
18	GND	Ground	44	GND	Ground
19	RO_CLKN	FIRST CLOCK CHANNEL C-	45	GND	Ground
20	RO_CLKP	FIRST CLOCK CHANNEL C+	46	GND	Ground
21	GND	Ground	47	NC	No connection
22	RO_3N	FIRST CHANNEL 3-	48	VLCD	Power Supply +12V
23	RO_3P	FIRST CHANNEL 3+	49	VLCD	Power Supply +12V
24	NC	No connection	50	VLCD	Power Supply +12V
25	NC	No connection	51	VLCD	Power Supply +12V
26	GND	Ground	-	-	-

Note: 1. All GND (ground) pin should be connected together to the LCD module's metal frame.

2. All  $V_{LCD}$  ( power input ) pins should be connected.



**LVDS Order = High → JEIDA**

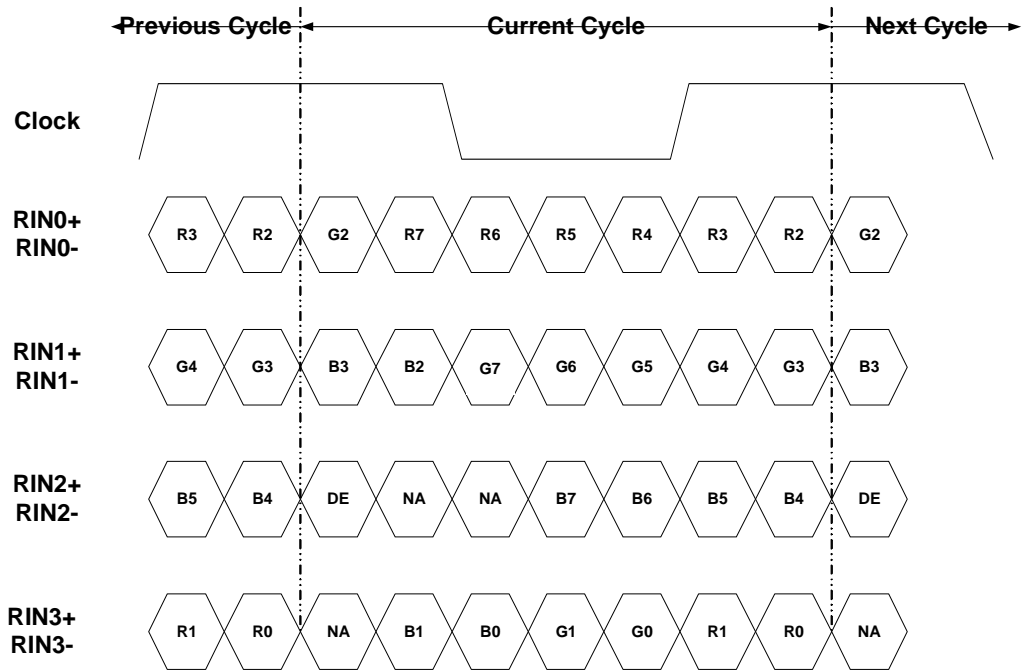

**LVDS Order = Low/Open → NS**

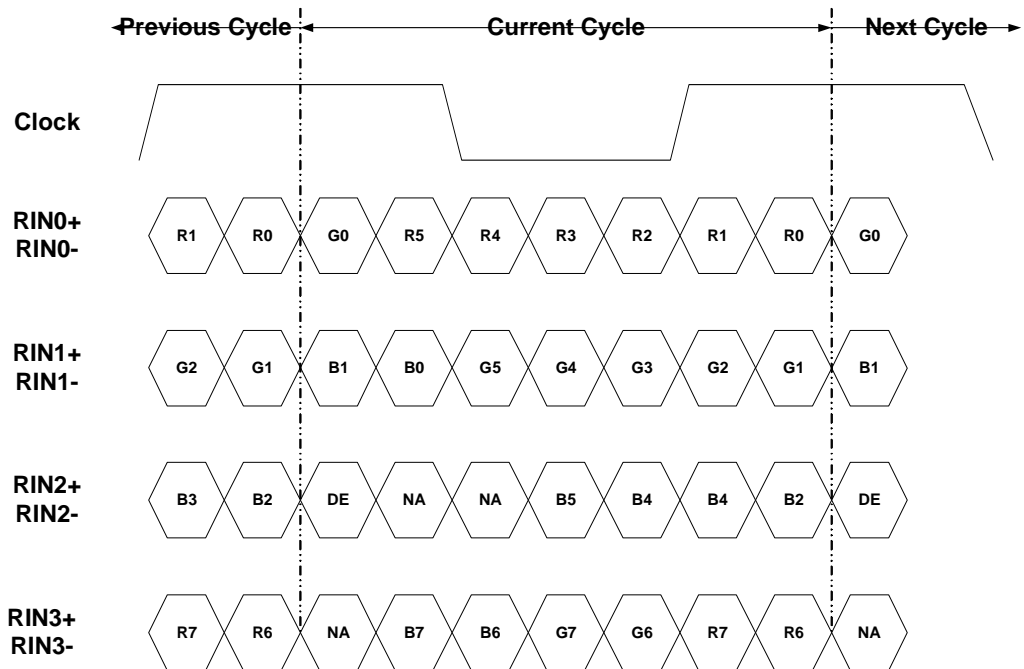



## Backlight Connector Pin Configuration

### 1. Electrical specification

No	ITEM	SYMBOL	CONDITION	MIN	TYP	MAX	UNIT	Note
1	Input Voltage	$V_{DDB}$	---	21.6	24.0	26.4	$V_{DC}$	
2	Input Current	$I_{DDB}$	$V_{DDB}=24V$ 100% Brightness	7.12	7.5	7.79	$A_{DC}$	
3	Input Power	$P_{DDB}$	$V_{DDB}=24V$ 100% Brightness		180		W	
4	Input inrush current	$I_{RUSH}$	$V_{DDB}=24V$ 100% Brightness		8.16		$A_{DC}$	
5	Output Frequency	$F_{BL}$	$V_{DDB}=24V$		44		KHz	
6	ON/OFF Control Voltage	$V_{BLON}$	ON	$V_{DDB}=24V$	2.0	---	3.3	$V_{DC}$
			OFF	$V_{DDB}=24V$	0.0	---	0.8	$V_{DC}$
7	ON/OFF Control Current	$I_{BLON}$	$V_{DDB}=24V$	0	---	2	$mA_{DC}$	
8	External PWM Control Voltage	$E_{VPWM}$	Max	---	2.0		3.3	V
			Min	---	0		0.8	V
9	External PWM Control Current	$E_{IPWM}$	Max	PWM=100%	0		2	mA
			Min	PWM=10%	0		2	mA
10	External PWM Duty Ratio	$E_{DPWM}$	---	10		100	%	
11	External PWM Frequency	$E_{FPWM}$	---	120	180	300	Hz	
12	Internal PWM Control Voltage	$I_{VPWM}$	$V_{DDB}$	0		3.3	V	

( $T_a=25\pm 5^{\circ}C$ , Turn on for 45minutes)

**\* Note : At < 20% dimming ratio, AUO would not guarantee display performance & start at High and Low Temperature condition.**



## 2. Input specification

Connector : S14B-PH-SM4-TB (JST) or equivalent

CN :S14B-PH-SM4-TB (JST)		
No	Signal Name	Feature
1	V <sub>DDB</sub>	Operating Voltage Supply,+24V DC regulated
2	V <sub>DDB</sub>	Operating Voltage Supply,+24V DC regulated
3	V <sub>DDB</sub>	Operating Voltage Supply,+24V DC regulated
4	V <sub>DDB</sub>	Operating Voltage Supply,+24V DC regulated
5	V <sub>DDB</sub>	Operating Voltage Supply,+24V DC regulated
6	GND	Ground and Current Return
7	GND	Ground and Current Return
8	GND	Ground and Current Return
9	GND	Ground and Current Return
10	GND	Ground and Current Return
11	Reserved	Reserved
12	V <sub>BLON</sub>	GND:BL Off; Open/High (3.3V):BL On
13	PDIM	External PWM (AC Signal Control Duty); Internal PWM (DC Power Control Duty,0~3.3V) Open/High (+3.3V,100% Duty) for 100%
14	PDIM Selection	GND: External PWM dimming; Open/High (3.3V):Internal PWM dimming

## 3-3 Signal Timing Specifications



This is the signal timing required at the input of the User connector. All of the interface signal timing should be satisfied with the following specifications for it's proper operation.

Timing Table (DE only Mode)

Signal	Item	Symbol	Min	Type	Max	Unit
Vertical Section	Period	Tv	1090	1125	1480	Th
	Active	Tdisp (v)	1080			Th
	Blanking	Tblk (v)	10	45	400	Th
Horizontal Section	Period	Th	1030	1100	1300	Tclk
	Active	Tdisp (h)	960			Tclk
	Blanking	Tblk (h)	70	140	340	Tclk
Clock	Period	CLK	20	13.47	12.9	ns
	Frequency	Freq	50	74.25	82	MHz
Vertical Frequency	Frequency	Vs	47	60	63	Hz
Horizontal Frequency	Frequency	Hs	60	67.5	73	KHz



### 3-4 Signal Timing Waveforms

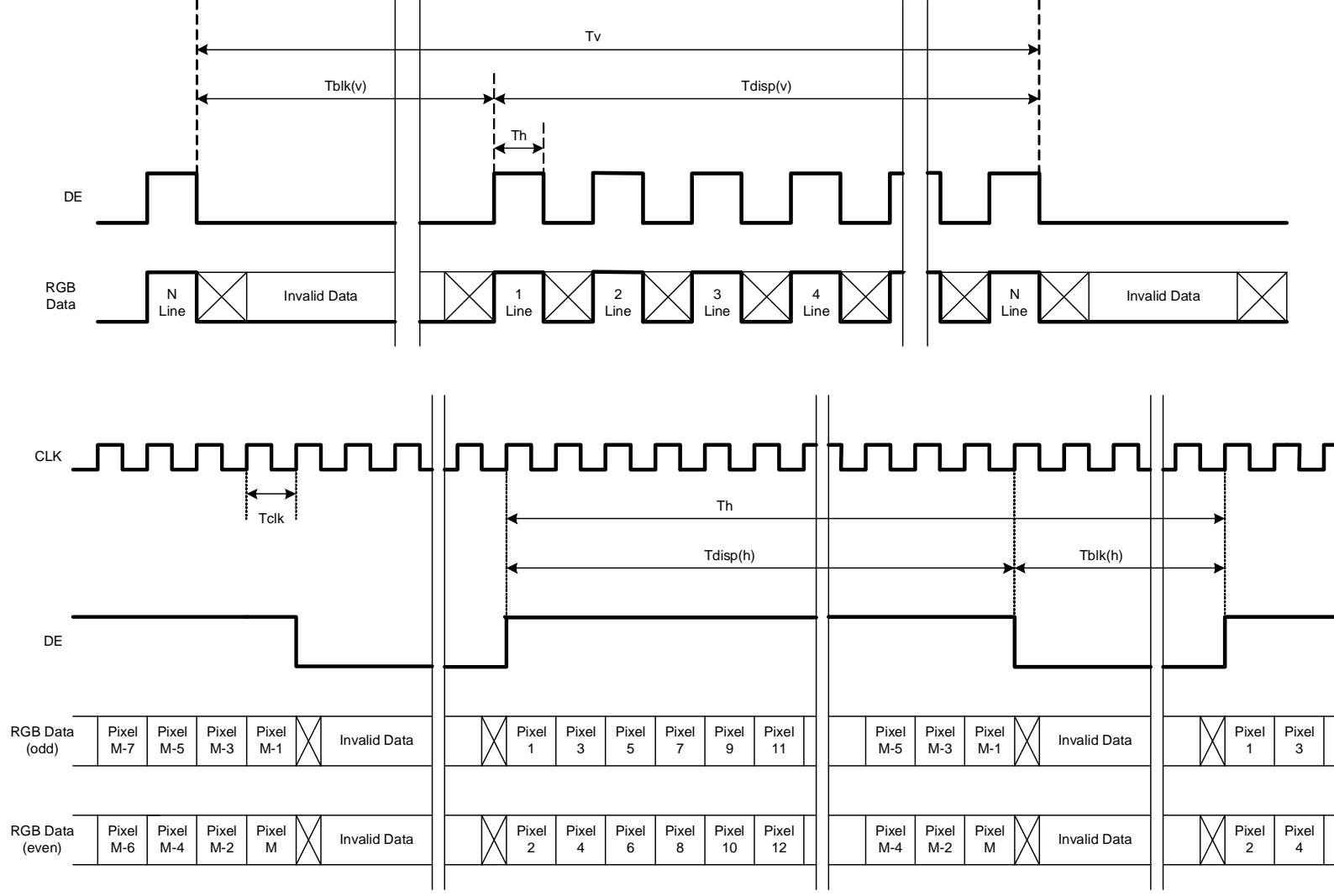



### 3-5 Color Input Data Reference

The brightness of each primary color (red, green and blue) is based on the 8 bit gray scale data input for the color; the higher the binary input, the brighter the color. The table below provides a reference for color versus data input.

#### COLOR DATA REFERENCE

Color		Input Color Data																							
		RED								GREEN								BLUE							
		MSB				LSB				MSB				LSB				MSB				LSB			
		R7	R6	R5	R4	R3	R2	R1	R0	G7	G6	G5	G4	G3	G2	G1	G0	B7	B6	B5	B4	B3	B2	B1	B0
Basic Color	Black	0	0	0	0	0	0	0	0	0	0	0	0	0	0	0	0	0	0	0	0	0	0	0	0
	Red(255)	1	1	1	1	1	1	1	1	0	0	0	0	0	0	0	0	0	0	0	0	0	0	0	0
	Green(255)	0	0	0	0	0	0	0	0	1	1	1	1	1	1	1	1	0	0	0	0	0	0	0	0
	Blue(255)	0	0	0	0	0	0	0	0	0	0	0	0	0	0	0	0	1	1	1	1	1	1	1	1
	Cyan	0	0	0	0	0	0	0	0	1	1	1	1	1	1	1	1	1	1	1	1	1	1	1	1
	Magenta	1	1	1	1	1	1	1	1	0	0	0	0	0	0	0	0	1	1	1	1	1	1	1	1
	Yellow	1	1	1	1	1	1	1	1	1	1	1	1	1	1	1	1	0	0	0	0	0	0	0	0
	White	1	1	1	1	1	1	1	1	1	1	1	1	1	1	1	1	1	1	1	1	1	1	1	1
RED	RED(000)	0	0	0	0	0	0	0	0	0	0	0	0	0	0	0	0	0	0	0	0	0	0	0	0
	RED(001)	0	0	0	0	0	0	0	1	0	0	0	0	0	0	0	0	0	0	0	0	0	0	0	0
	----																								
	RED(254)	1	1	1	1	1	1	1	0	0	0	0	0	0	0	0	0	0	0	0	0	0	0	0	0
	RED(255)	1	1	1	1	1	1	1	1	0	0	0	0	0	0	0	0	0	0	0	0	0	0	0	0
GREEN	GREEN(000)	0	0	0	0	0	0	0	0	0	0	0	0	0	0	0	0	0	0	0	0	0	0	0	0
	GREEN(001)	0	0	0	0	0	0	0	0	0	0	0	0	0	0	1	0	0	0	0	0	0	0	0	
	----																								
	GREEN(254)	0	0	0	0	0	0	0	0	1	1	1	1	1	1	1	0	0	0	0	0	0	0	0	0
	GREEN(255)	0	0	0	0	0	0	0	0	1	1	1	1	1	1	1	1	0	0	0	0	0	0	0	0
BLUE	BLUE(000)	0	0	0	0	0	0	0	0	0	0	0	0	0	0	0	0	0	0	0	0	0	0	0	0
	BLUE(001)	0	0	0	0	0	0	0	0	0	0	0	0	0	0	0	0	0	0	0	0	0	0	0	1
	-----																								
	BLUE(254)	0	0	0	0	0	0	0	0	0	0	0	0	0	0	0	0	1	1	1	1	1	1	1	0
	BLUE(255)	0	0	0	0	0	0	0	0	0	0	0	0	0	0	0	0	1	1	1	1	1	1	1	1

### 3-6 Power Sequence

#### 1. Power sequence of panel

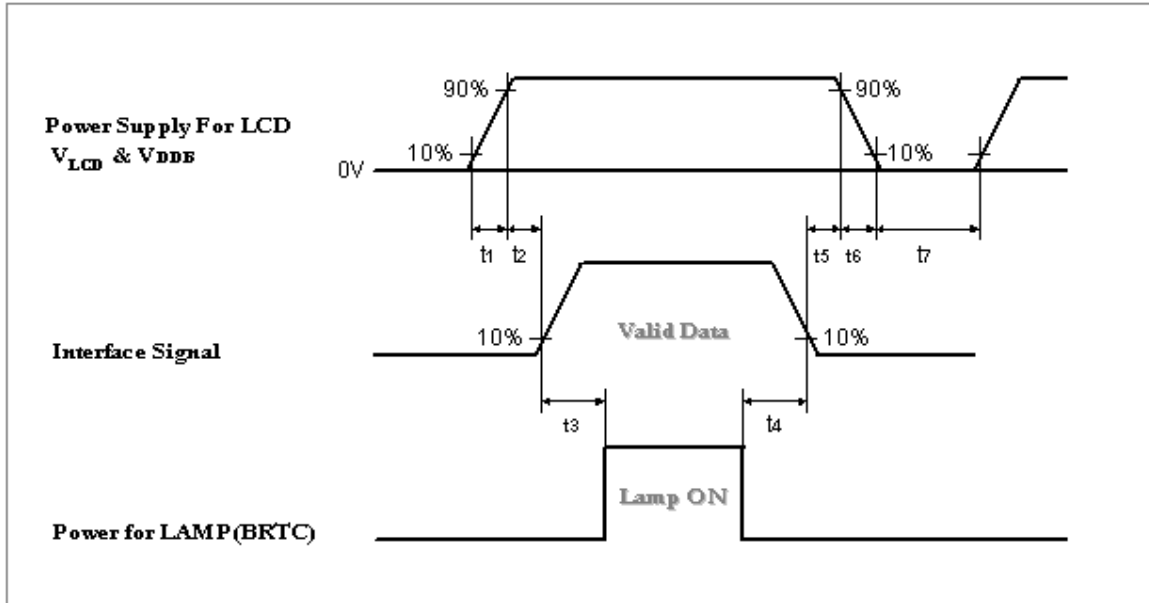

Parameter	Values			Units
	Min.	Typ.	Max.	
t1	0.4	-	30	ms
t2	0.1	-	50	ms
t3	300	-	-	ms
t4	100	-	-	ms
t5	0.1	-	50	ms
t6		-	300	ms
t7	1000	-	-	ms

Apply the lamp voltage within the LCD operating range. When the backlight turns on before the LCD operation or the LCD turns off before the backlight turns off, the display may momentarily become abnormal.

**Caution :** The above on/off sequence should be applied to avoid abnormal function in the display. In case of handling, make sure to turn off the power when you plug the cable into the input connector or pull the cable out of the connector.



## 2. Power sequence of inverter

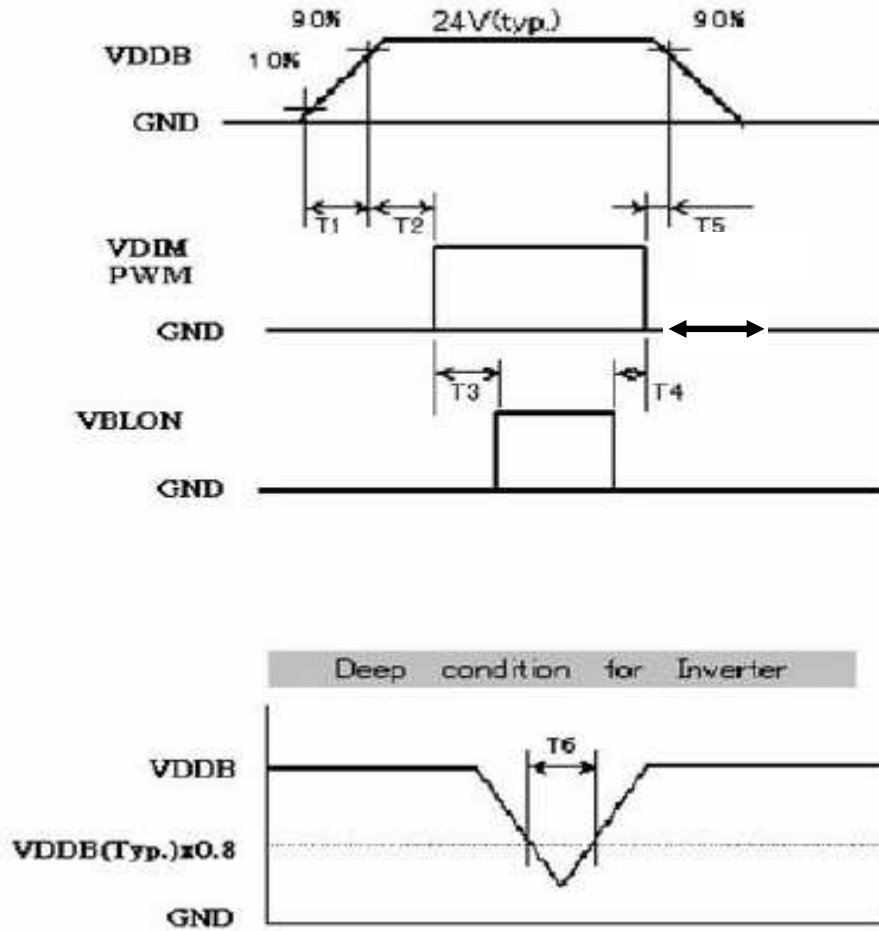

Parameter	Values			Units
	Min.	Typ.	Max.	
T1	20	-	-	ms
T2	500	-	-	ms
T3	250	-	-	ms
T4	0	-	-	ms
T5	1	-	-	ms
T6			10	ms



## 4. Optical Specification

Optical characteristics are determined after the unit has been 'ON' and stable for approximately 60 minutes in a dark environment at 25°C. The values specified are at an approximate distance 50cm from the LCD surface at a viewing angle of  $\Phi$  and  $\theta$  equal to 0°.

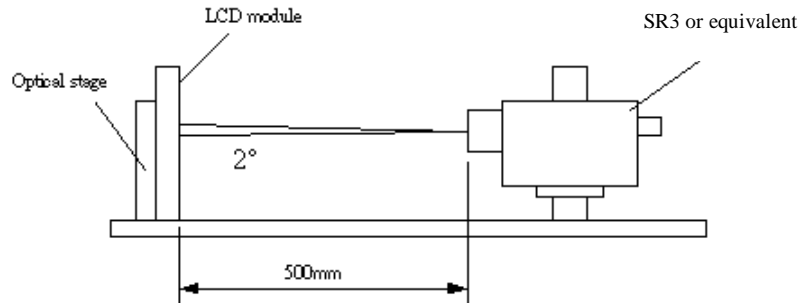

Fig.4-1 Optical measurement equipment and method

Parameter	Symbol	Values			Units	Notes
		Min.	Typ.	Max.		
Contrast Ratio	CR	2500	3500			1
Surface Luminance, white	LWH	600	700		cd/m <sup>2</sup>	2
Luminance Variation	$\delta_{\text{WHITE}}$ 5p			1.3		3
Response Time (Average)	$T_{\gamma}$		6.5		ms	4,5 (Gray to Gray)
Color Coordinates						
	RED	$R_x$	Typ.-0.03	0.640	Typ.+0.03	
		$R_y$		0.330		
	GREEN	$G_x$		0.290		
		$G_y$		0.600		
	BLUE	$B_x$		0.150		
		$B_y$		0.060		
	WHITE	$W_x$		0.280		
		$W_y$		0.290		
Viewing Angle						
	x axis, right( $\varphi=0^\circ$ )	$\theta_r$		89	Degree	5
	x axis, left( $\varphi=180^\circ$ )	$\theta_l$		89		
	y axis, up( $\varphi=90^\circ$ )	$\theta_u$		89		
	y axis, down ( $\varphi=0^\circ$ )	$\theta_d$		89		

Note:

1. Contrast Ratio (CR) is defined mathematically as:

$$\text{Contrast ratio (CR)} = \frac{\text{Brightness on the "white" state}}{\text{Brightness on the "black" state}}$$

2. Surface luminance is luminance value at point 1 across the LCD surface 50cm from the surface with all pixels displaying white. From more information see Fig. 4-2. When  $V_{DDB} = 24V$ ,  $I_{DDB} = 7.5A$ .  $L_{WH} = L_{on1}$ , Where  $L_{on1}$  is the luminance with all pixels displaying white at center 1 location.

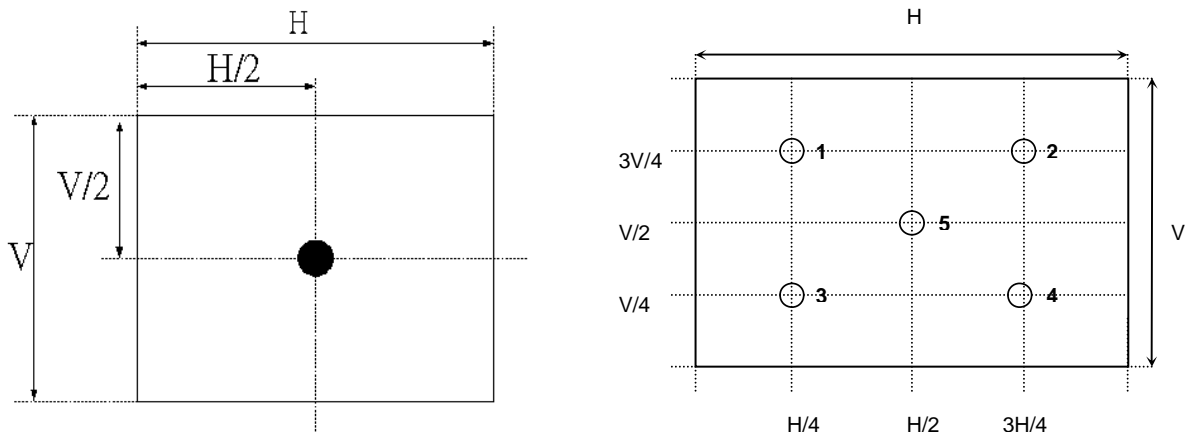

**Fig.4-2 Optical measurement point**

3. The variation in surface luminance,  $\delta_{WHITE}$  is defined under 100% brightness as:

$$\delta_{WHITE(5P)} = \frac{\text{Maximum}(L_{on1}, L_{on2}, \dots, L_{on5})}{\text{Minimum}(L_{on1}, L_{on2}, \dots, L_{on5})}$$

4. Response Time:

(a) G-to-G: average response time among brightness of 0%, 25%, 50%, 75% & 100%.

	0%	25%	50%	75%	100%
0%		tr: 0%→25%	tr: 0%→50%	tr: 0%→75%	tr: 0%→100%
25%	tf: 25%→0%		tr: 25%→50%	tr: 25%→75%	tr: 25%→100%
50%	tf: 50%→0%	tf: 50%→25%		tr: 50%→75%	tr: 50%→100%
75%	tf: 75%→0%	tf: 75%→25%	tf: 75%→50%		tr: 75%→100%
100%	tf: 100%→0%	tf: 100%→25%	tf: 100%→50%	tf: 100%→75%	

5. Viewing angle is the angle at which the contrast ratio is greater than 10. The angles are determined for the horizontal or x axis and the vertical or y axis with respect to the z axis which is normal to the LCD surface. For more information see Fig. 4-3. (Optical measurement by SR3)

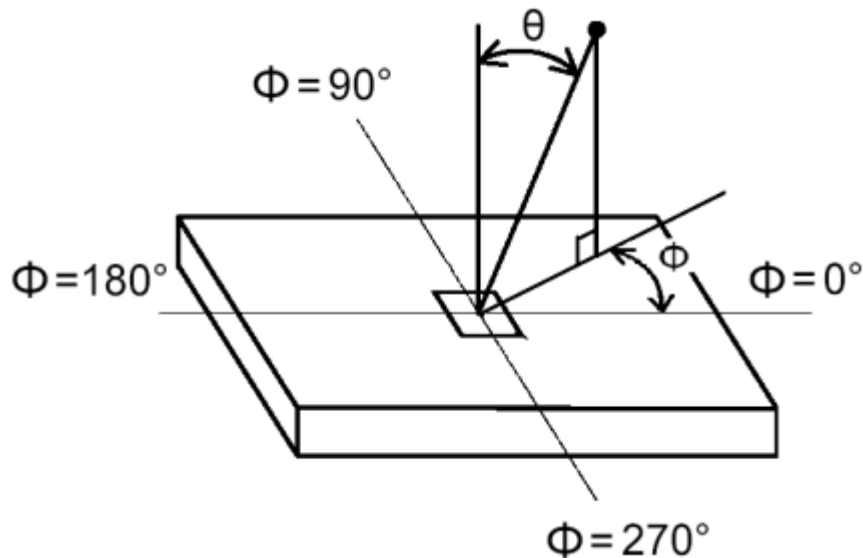

Fig.4-3 Viewing Angle Definition



## 5. Mechanical Characteristics

The contents provide general mechanical characteristics for the model P420HW01. In addition the figures in the next page are detailed mechanical drawing of the LCD.

Outline Dimension	Horizontal (typ.)	983.0mm
	Vertical (typ.)	576.0mm
	Depth (typ.)	52.5mm (with inverter)
Bezel Area	Horizontal (typ.)	939.0mm
	Vertical (typ.)	531.0mm
Active Display Area	Horizontal	930.24mm
	Vertical	523.26mm
Weight	11100 (typ),	
Surface Treatment	Anti-Glare coating (Haze 11%) Hard coating (3H)	



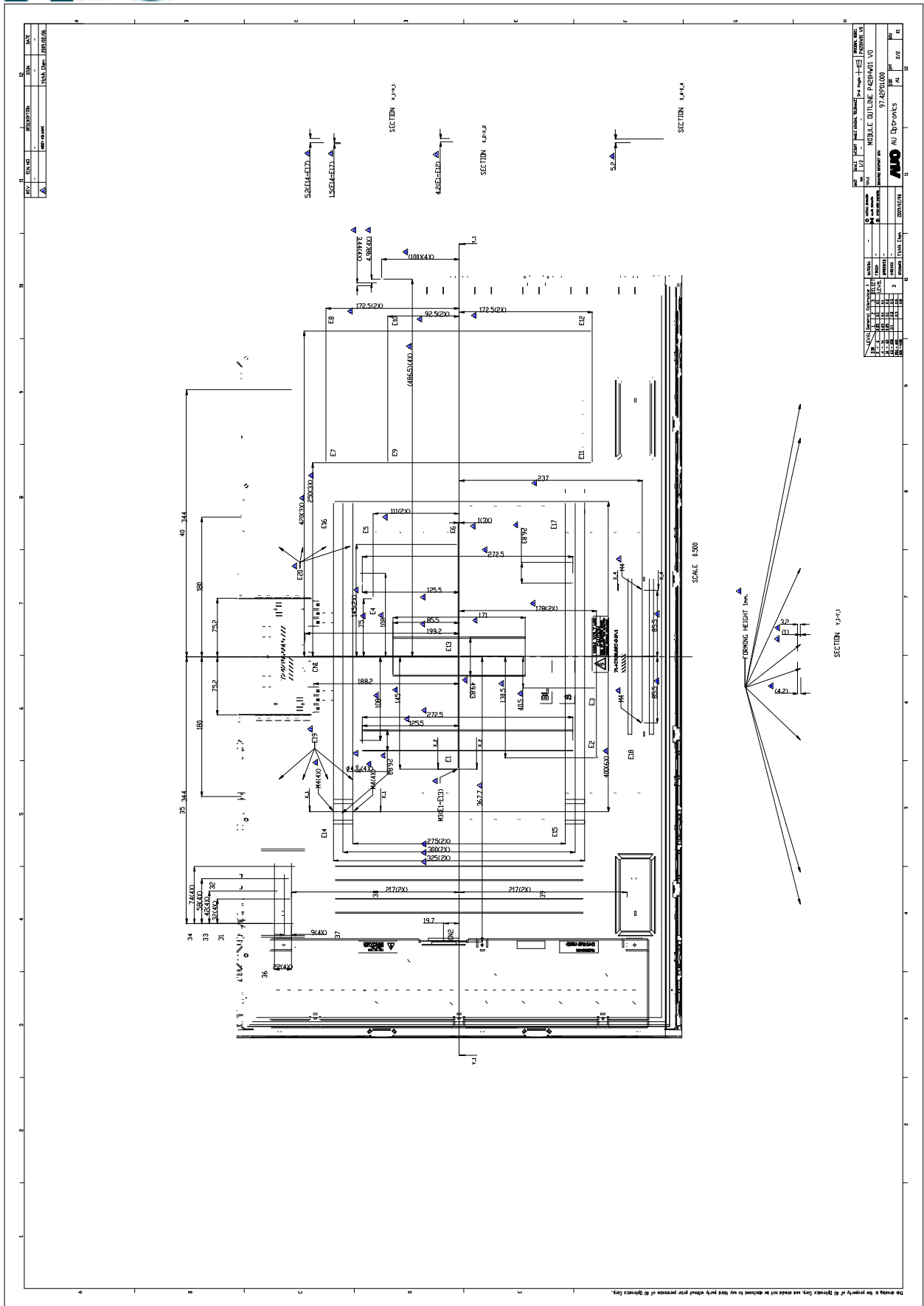



## 6. Reliability

Panel condition in RA test

Brightness: 700nits

No	Test Item	Condition
1	High temperature storage test	Ta=60°C 300h
2	Low temperature storage test	Ta= -20°C 300h
3	High temperature operation test	Ta=50°C 300h
4	Low temperature operation test	Ta=-5°C 300h
5	Vibration test (non-operating)	Wave form: random Vibration level: 1.5G RMS Bandwidth: 10-300Hz, Duration: X, Y, Z 30min One time each direction
6	Shock test (non-operating)	Shock level: 50G Waveform: half sine wave, 11ms Direction: ±X, ±Y, ±Z One time each direction
7	Vibration test (with carton)	Wave form: random Vibration level: 1.5G RMS Bandwidth: 10-200Hz, Duration: X, Y, Z 30min One time each direction
8	Drop test (with carton)	Height: 25.4cm 1 corner, 3 edges, 6 surfaces (ASTMD4169-I)

### Result Evaluation Criteria

There should be no change which might affect the practical display function when the display quality test is conducted under normal operating condition.





## 7. International Standard

### 7-1. Safety

- (1) UL60065, Underwriters Laboratories, Inc. (AUO file number : E204356)  
Standard for Safety of Information Technology Equipment Including electrical Business Equipment.
- (2) CSA E60065, Canadian Standards Association  
Standard for Safety of Information Technology Equipment Including Electrical Business Equipment.
- (3) IEC 60065 ver. 7<sup>th</sup>, European Committee for Electro technical Standardization (CENELEC)  
EUROPEAN STANDARD for Safety of Information Technology Equipment Including Electrical Business Equipment.

### 7-2. EMC

- (1) ANSI C63.4 “Methods of Measurement of Radio-Noise Emissions from Low-Voltage Electrical and Electrical Equipment in the Range of 9kHz to 40GHz. “American National standards Institute(ANSI), 1992
- (2) C.I.S.P.R “Limits and Methods of Measurement of Radio Interface Characteristics of Information Technology Equipment.” International Special committee on Radio Interference.
- (3) EN 55022 “Limits and Methods of Measurement of Radio Interface Characteristics of Information Technology Equipment.” European Committee for Electrotechnical Standardization. (CENELEC), 1998



## 8. Packing : Packing Instruction

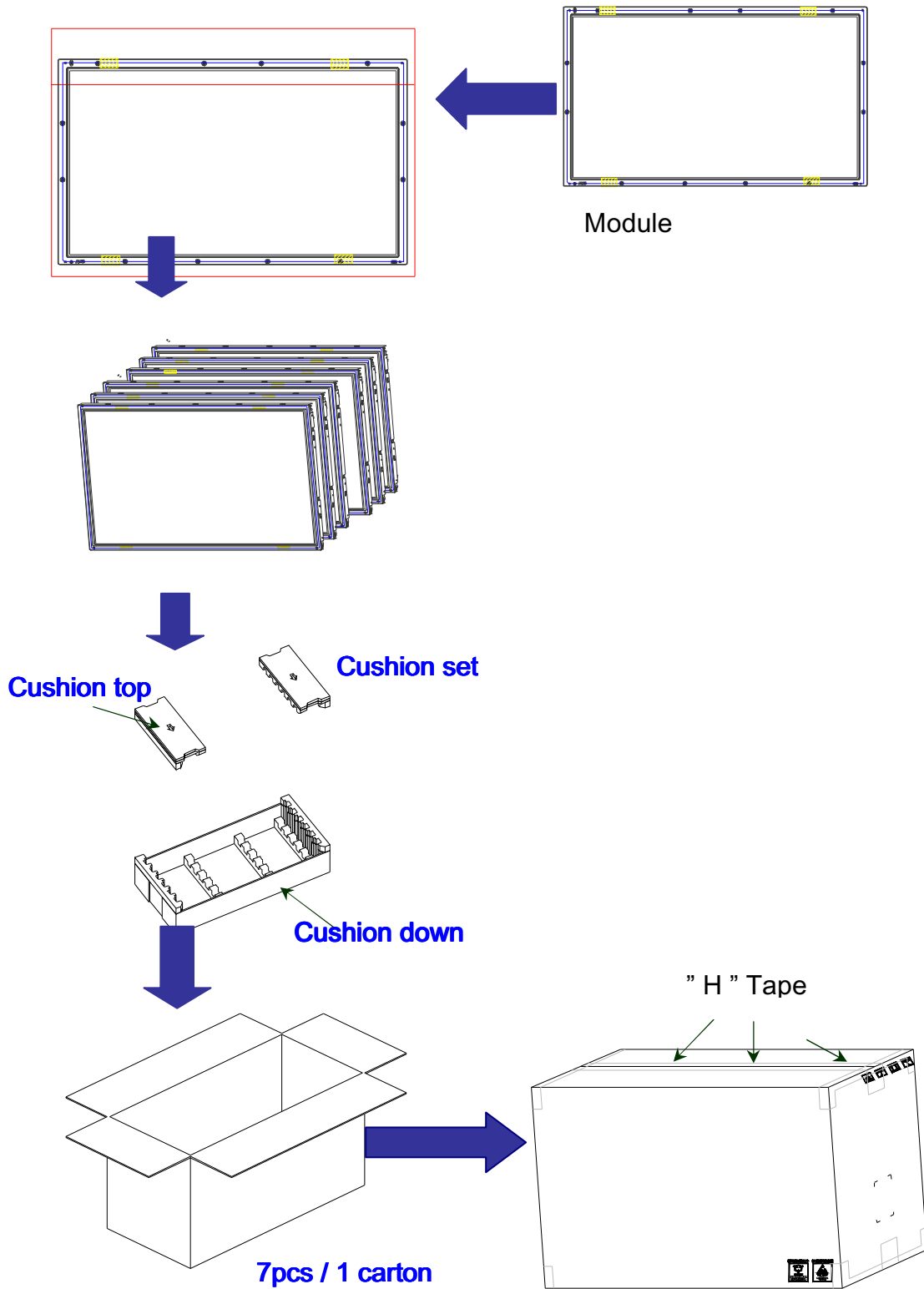



## Shipping label



### Green Mark Description:

For Pb Free products, AUO will add  for identification.

For RoHS compatible products, AUO will add  for identification.

**Note:** The Green Mark will be present only when the green documents have been ready by AUO

Internal Green Team. (The definition of green design follows the AUO green design checklist.)

## Carton label

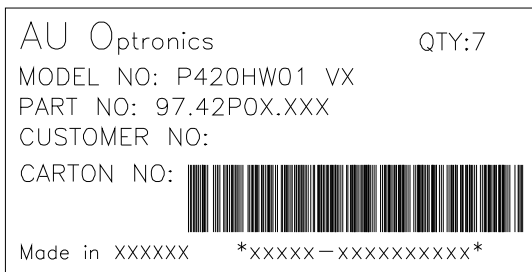

## Pallet information

By air cargo : : (2x1) x1 layers, one pallet put 2 boxes, 1layers(1pallet) total 14 pcs module.

By sea : (2x1) x3 layers, one pallet put 2 boxes, 3layers(3pallet) total 42 pcs module.

Pallet dimension : 1150x1070x132mm

Pallet weight : 10kg

By air total weight : 95kg/box X 2 boxes=190 kg (with 1 pallet weight 200kg)

By sea total weight : 95kg/box X 6 boxes=570 kg (with 3 pallet weight 600kg)

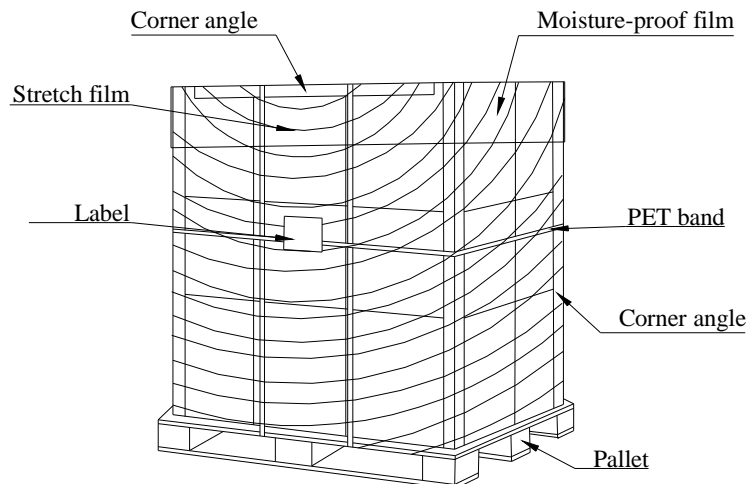



## 9. PRECAUTIONS

Please pay attention to the followings when you use this TFT LCD module.

### 9-1 MOUNTING PRECAUTIONS

- (1) You must mount a module using holes arranged on back side of panel.
- (2) Please attach the surface transparent protective plate to the surface in order to protect the polarizer. Transparent protective plate should have sufficient strength in order to resist external force.
- (3) You should adopt radiation structure to satisfy the temperature specification.
- (4) Acetic acid type and chlorine type materials for the cover case are not desirable because the former generates corrosive gas of attacking the polarizer at high temperature and the latter causes circuit break by electro-chemical reaction.
- (5) Do not touch, push or rub the exposed polarizers with glass, tweezers or anything harder than HB pencil lead. And please do not rub with dust clothes with chemical treatment. Do not touch the surface of polarizer for bare hand or greasy cloth. (Some cosmetics are detrimental to the polarizer.)
- (6) When the surface becomes dusty, please wipe gently with absorbent cotton or other soft materials like chamois soaks with petroleum benzene. Normal-hexane is recommended for cleaning the adhesives used to attach front/ rear polarizers. Do not use acetone, toluene and alcohol because they cause chemical damage to the polarizer.
- (7) Wipe off saliva or water drops as soon as possible. Their long time contact with polarizer causes deformations and color fading.
- (8) Do not open the case because inside circuits do not have sufficient strength.

### 9-2 OPERATING PRECAUTIONS

- (1) The spike noise causes the mis-operation of circuits. It should be lower than following voltage:  
 $V = \pm 200\text{mV}$  (Over and under shoot voltage)
- (2) Response time depends on the temperature. (In lower temperature, it becomes longer..)
- (3) Brightness depends on the temperature. (In lower temperature, it becomes lower.) And in lower temperature, response time (required time that brightness is stable after turned on) becomes longer.
- (4) Be careful for condensation at sudden temperature change. Condensation makes damage to polarizer or electrical contacted parts. And after fading condensation, smear or spot will occur.
- (5) When fixed patterns are displayed for a long time, remnant image is likely to occur.



- (6) Module has high frequency circuits. Sufficient suppression to the electromagnetic interference shall be done by system manufacturers. Grounding and shielding methods may be important to minimize the interface.

### **9-3 ELECTROSTATIC DISCHARGE CONTROL**

Since a module is composed of electronic circuits, it is not strong to electrostatic discharge. Make certain that treatment persons are connected to ground through wrist band etc. And don't touch interface pin directly.

### **9-4 PRECAUTIONS FOR STRONG LIGHT EXPOSURE**

Strong light exposure causes degradation of polarizer and color filter.

### **9-5 STORAGE**

When storing modules as spares for a long time, the following precautions are necessary.

- (1) Store them in a dark place. Do not expose the module to sunlight or fluorescent light. Keep the temperature between 5°C and 35°C at normal humidity.
- (2) The polarizer surface should not come in contact with any other object. It is recommended that they be stored in the container in which they were shipped.

### **9-6 HANDLING PRECAUTIONS FOR PROTECTION FILM**

- (1) The protection film is attached to the bezel with a small masking tape. When the protection film is peeled off, static electricity is generated between the film and polarizer. This should be peeled off slowly and carefully by people who are electrically grounded and with well ion-blown equipment or in such a condition, etc.
- (2) When the module with protection film attached is stored for a long time, sometimes there remains a very small amount of glue still on the Bezel after the protection film is peeled off.
- (3) You can remove the glue easily. When the glue remains on the Bezel or its vestige is recognized, please wipe them off with absorbent cotton waste or other soft material like chamois soaked with normal-hexane.

### **9-7 Operating Condition in PID Application**

- (1) If the continuous static display is required, periodically inserting a motion picture is strongly recommended.
- (2) Recommend to periodically change the background color and background image.
- (3) Recommend not to continuously operate over 18 hours a day.
- (4) Recommend to adopt one of the following actions after long time display.
  - I. Running the screen saver (motion picture or black pattern)



II. Power off the system for a while

- (5) Try not to run the LCD in a closed environment. Suitable venting on the system cover would be helpful for cooling.
- (6) It is better to adapt active cooling with fans for long time displaying, especially for high luminance LCD model.