

GA-2AIEV-RH
GA-2AIEV2-RH
GA-2AIEV3-RH
AMD® mini-ITX Motherboard
USER'S MANUAL

AMD® mini-ITX Motherboard
Rev. 1001



* The WEEE marking on the product indicates this product must not be disposed of with user's other household waste and must be handed over to a designated collection point for the recycling of waste electrical and electronic equipment!!!



* The WEEE marking applies only in European Union's member states.

GA-2AIEV-RH/GA-2AIEV2-RH/GA-2AIEV3-RH Motherboard

Copyright

© 2008 GIGA-BYTE TECHNOLOGY CO., LTD. All rights reserved.

The trademarks mentioned in the manual are legally registered to their respective companies.

Notice

The written content provided with this product is the property of Gigabyte.

No part of this manual may be reproduced, copied, translated, or transmitted in any form or by any means without Gigabyte's prior written permission. Specifications and features are subject to change without prior notice.

Product Manual Classification

In order to assist in the use of this product, Gigabyte has categorized the user manual in the following:

- For detailed product information and specifications, please carefully read the "Product User Manual".
- For detailed information related to Gigabyte's unique features, please go to "Technology Guide" section on Gigabyte's website to read or download the information you need.

For more product details, please click onto Gigabyte's website at www.gigabyte.com.tw

Table of Contents

Item Checklist	4
Chapter 1 Introduction	5
1-1 Considerations Prior to Installation	5
1.2 Features Summary	6
1.3 Motherboard Components (GA-2AIEV2-RH)	8
1.4 Motherboard Components	9
(GA-2AIEV-RH/GA-2AIEV3-RH)	9
Chapter 2 Hardware Installation Process	10
2-1: Installing Processor	10
2-2: Installing Processor Colling Fan	11
2-3: Install Memory Modules	12
2-4: Connect ribbon cables, cabinet wires, and power supply	13
2-4-1 : I/O Back Panel Introduction (GA-2AIEV2-RH)	13
2-4-2 : I/O Back Panel Introduction (GA-2AIEV-RH/GA-2AIEV3-RH)	14
2-5: Connectors Introduction	19
2-6: Block Diagram	28
Chapter 3 BIOS Setup	29
Main	31
Advanced	34
System Information	35
CPU Feature	36
Advanced Chipset Control	37
I/O Device Configuration	39
Power Feature	40
Hardware Monitor	42
Security	46
TPM State	48
Boot	49
Exit	50

Item Checklist

- The GA-2AIEV-RH motherboard (for GA--2AIEV-RH motherboard)
- The GA-2AIEV2-RH motherboard (for GA--2AIEV2-RH motherboard)
- The GA-2AIEV3-RH motherboard (for GA--2AIEV3-RH motherboard)
- Serial ATA cable x 2
- I/O Shield Kit
- CD for motherboard driver & utility
- GA--2AIEV-RH Quick Reference Guide (for GA--2AIEV-RH motherboard)
- GA--2AIEV2-RH Quick Reference Guide (for GA--2AIEV2-RH motherboard)
- GA--2AIEV3-RH Quick Reference Guide (for GA--2AIEV3-RH motherboard)

* The items listed above are for reference only, and are subject to change without notice.

Chapter 1 Introduction

1-1 Considerations Prior to Installation

Preparing Your Computer

The motherboard contains numerous delicate electronic circuits and components which can become damaged as a result of electrostatic discharge (ESD). Thus, prior to installation, please follow the instructions below:

1. Please turn off the computer and unplug its power cord.
2. When handling the motherboard, avoid touching any metal leads or connectors.
3. It is best to wear an electrostatic discharge (ESD) cuff when handling electronic components (CPU, RAM).
4. Prior to installing the electronic components, please have these items on top of an antistatic pad or within a electrostatic shielding container.
5. Please verify that the power supply is switched off before unplugging the power supply connector from the motherboard.

Installation Notices

1. Prior to installation, please do not remove the stickers on the motherboard. These stickers are required for warranty validation.
2. Prior to the installation of the motherboard or any hardware, please first carefully read the information in the provided manual.
3. Before using the product, please verify that all cables and power connectors are connected.
4. To prevent damage to the motherboard, please do not allow screws to come in contact with the motherboard circuit or its components.
5. Please make sure there are no leftover screws or metal components placed on the motherboard or within the computer casing.
6. Please do not place the computer system on an uneven surface.
7. Turning on the computer power during the installation process can lead to damage to system components as well as physical harm to the user.
8. If you are uncertain about any installation steps or have a problem related to the use of the product, please consult a certified computer technician.

Instances of Non-Warranty

1. Damage due to natural disaster, accident or human cause.
2. Damage as a result of violating the conditions recommended in the user manual.
3. Damage due to improper installation.
4. Damage due to use of uncertified components.
5. Damage due to use exceeding the permitted parameters.
6. Product determined to be an unofficial Gigabyte product.

1.2 Features Summary

Form Factor	<ul style="list-style-type: none"> • 170mm x 170mm Mini ITX form factor, 8 layers PCB.
CPU	<ul style="list-style-type: none"> • Supports AMD® AM2/AM2+ processor • AMD® Dual/QuadCore in AM2 socket
Chipset (GA-2AIEV-RH)	<ul style="list-style-type: none"> • AMD® 780MN • AMD® SB700
Chipset (GA-2AIEV2-RH)	<ul style="list-style-type: none"> • AMD® 780M • AMD® SB700
Chipset (GA-2AIEV-3RH)	<ul style="list-style-type: none"> • AMD® 780E • AMD® SB700
Memory	<ul style="list-style-type: none"> • 2 x DDR2 DIMM sockets • Supports up to 4GB 533/667/800 memory • Supports 1.8V DDR2 DIMMs
I/O Control	<ul style="list-style-type: none"> • ITE IT8720F Super I/O
Expansion Slots	<ul style="list-style-type: none"> • Supports 1 PCI-E x16 (x8 bandwidth)
SATA Controller	<ul style="list-style-type: none"> • Built in AMD® SB700 with RAID 0,1,10, 5 • Supports 6 SATA connectors
On-Board Graphic	<ul style="list-style-type: none"> • Build in AMD® 780MN (GA-2AIEV-RH) • Build in AMD® 780M (GA-2AIEV2-RH) • Build in AMD® 780E (GA-2AIEV3-RH)
On-Board Sound	<ul style="list-style-type: none"> • Realtek® ALC889A
Internal Connector	<ul style="list-style-type: none"> • 1 x 24-pin ATX power connector • 6 x SATA connectors • 2 x Serial connectors (COM) • 1 x PS/2 connector • 1 x front audio connector • 1 x LVDS connector • 2 x USB 2.0 connectors for additional 4 ports by cable • 1 x front panel connector • 1 x System fan cable connector • 1 x CPU fan cable connector
Rear Panel I/O	<ul style="list-style-type: none"> • 2 x SPDIF Out (Optical + Coaxial)** • 1 x YPbPr prot (HDTV out)** • 1 x HDMI prot • 1 x VGA port

GA-2AIEV-RH/GA-2AIEV2-RH/GA-2AIEV3-RH Motherboard

- 4 x USB 2.0 ports
- 2 x LAN RJ45 ports
- 1 HD Audio jacks (Line-out / MIC-in / Line-in) can configure 5.1 channel output by utility

****Note** SPDIF Out (Optical + Coaxial) device only for GA-2AIEV2-RH**

Hardware Monitor	<ul style="list-style-type: none">• Enhanced features with CPU Vcore, 1.5V reference, VCC3 (3.3V) , VBAT3V, +5VSB, CPUA/B Temperature, and System Temperature Values viewing• CPU/Power/System Fan Revolution Detect• CPU shutdown when overheat
On-Board LAN	<ul style="list-style-type: none">• Dual Broadcom® BCM5764M GbE controller• Supports WOL, PXE
BIOS	<ul style="list-style-type: none">• Phoenix BIOS on 8Mb SPI Flash ROM
Additional Features	<ul style="list-style-type: none">• External Modem wake up• Supports S1, S3, S4, S5 under Windows Operating System• Wake on LAN (WOL)• Supports Console Redirection• Supports 4-pin Fan controller

1.3 Motherboard Components (GA-2AIEV2-RH)

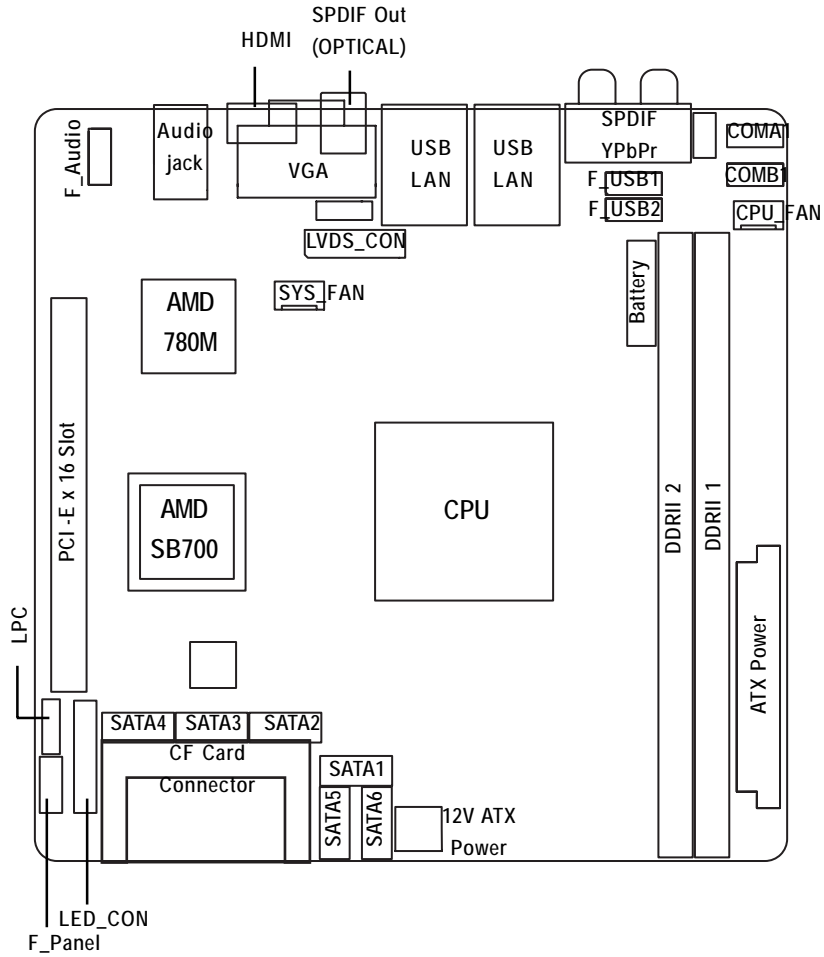

1.4 Motherboard Components (GA-2AIEV-RH/GA-2AIEV3-RH)

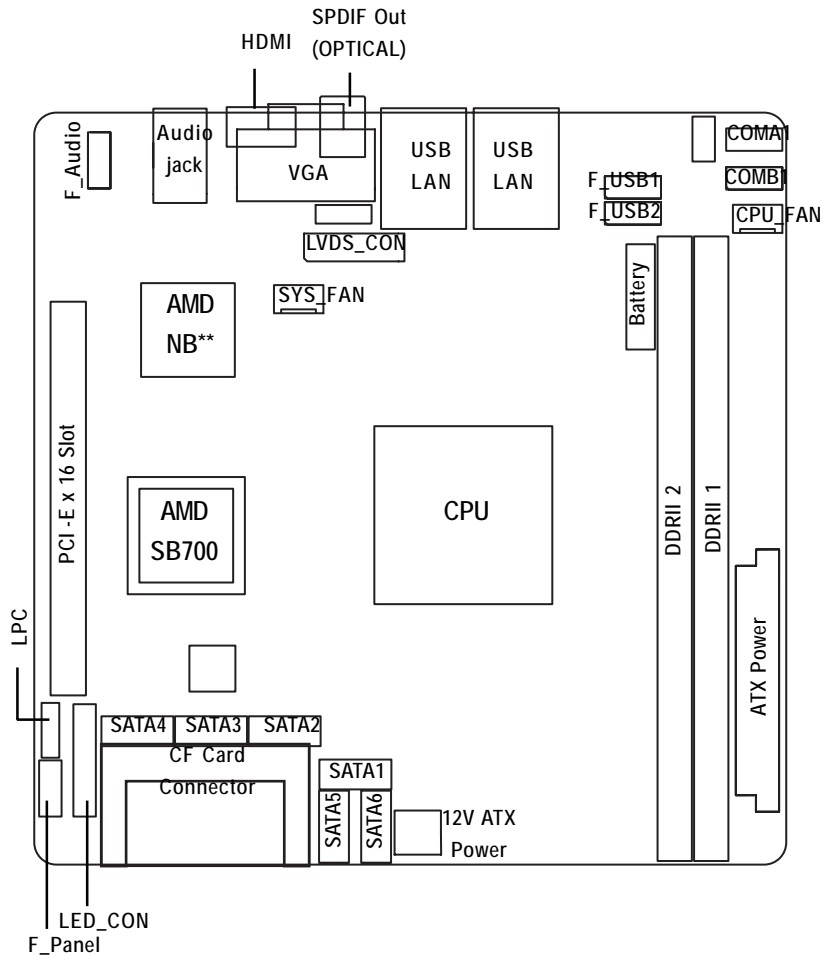

Note GA-2AIEV-RH: AMD 780MN
GA-2AIEV3-RH: AMD 780E

Chapter 2 Hardware Installation Process

2-1: Installing Processor



Check the CPU pins are not bent.

- Step 1 Raise the locking lever next to the socket prior to installing the CPU.
- Step 2 Insert the CPU with the correct orientation. The CPU only fits in one orientation. When CPU is placed into socket properly, push the locking lever back into locked position.

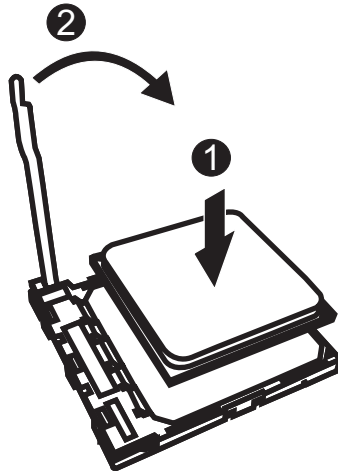

2-2: Installing Processor Colling Fan



WARNING!

To prevent the CPU overheat, please make sure you have apply the CPU cooler paste on the surface of installed CPU

- Step 1 Attach the cooling fan clip to the processor socket.
- Step 2 Align the heatsink assembly with the support frame mating with the backer plate standoffs.
- Step 3 Press down the clip to lock the heaksink securely. Coonect the processor fan cable to the processor fan connector.



2-3: Install Memory Modules



CAUTION

Before installing the memory modules, please comply with the following conditions:

1. Please make sure the computer power is switched off before installing or removing memory modules.

The motherboard supports DDR2 memory module, whereby BIOS will automatically detect memory capacity and specifications. The memory module only can be inserted in one direction.

Installation Steps:

- Step 1. Unlock a DIMM socket by pressing the retaining clips outwards. Aling a DIMM on the socket such that the notch on the DIMM exactly match the notch in the socket.
- Step 2. Firmly insert the DIMM into the socket until the retaining clips snap back in place. Reverse the installation steps if you want to remove the DIMM module.

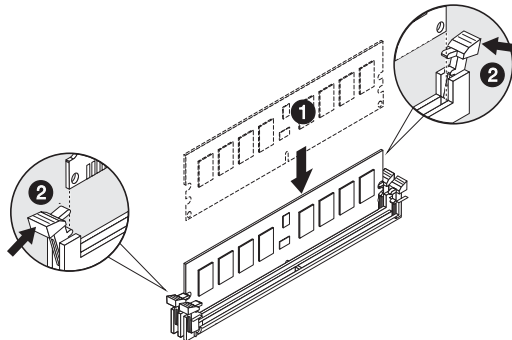
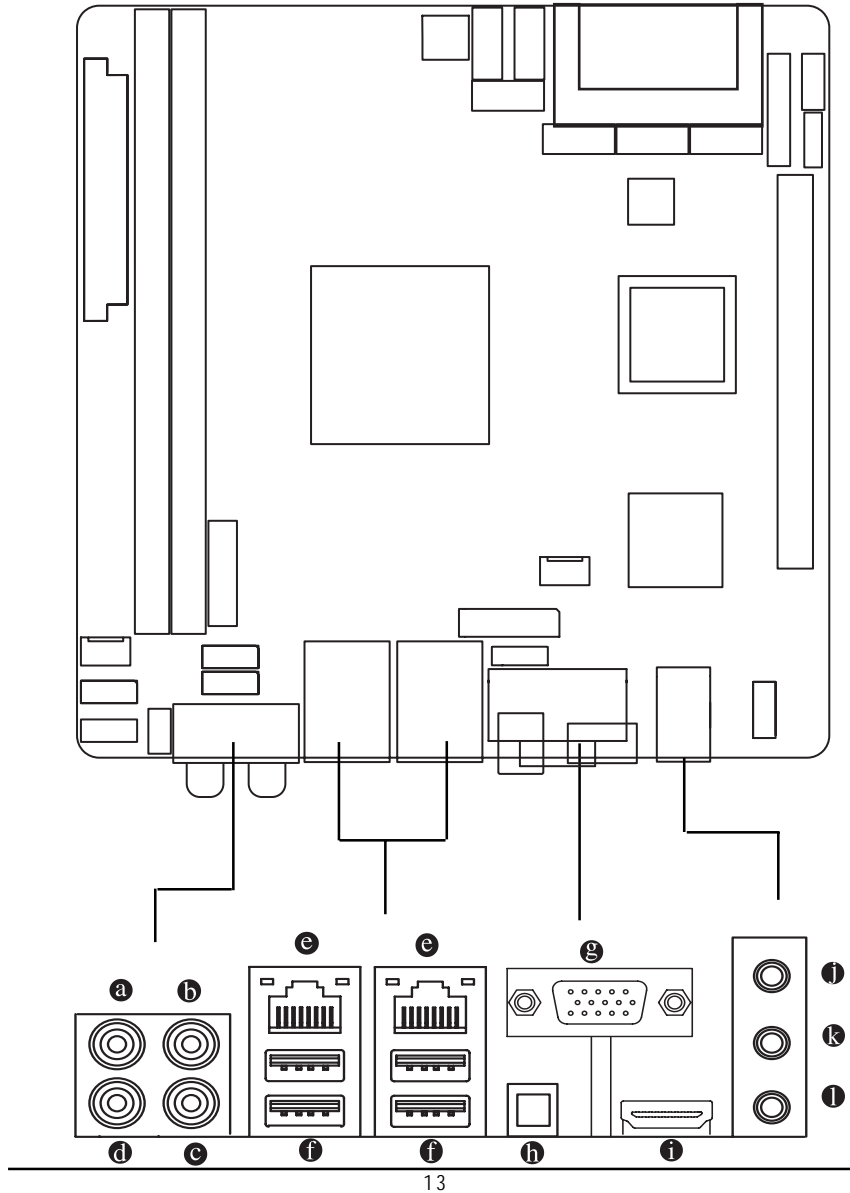

Table 1. Supported DIMM Module Type

Size	Organization	RAM Chips/DIMM
256MB	8MB x 8 x 4 bks	8
	16MB x 16 x 4bks	16
512MB	16MB x 8 x 4bks	8
	32MB x 16 x 4bks	16
1GB	32MB x 8 x 4bks	8
	64MB x 16 x 4bks	16
2GB	32MB x 8 x 4bks	8
	64MB x 16 x 4bks	16

2-4: Connect ribbon cables, cabinet wires, and power supply

2-4-1 : I/O Back Panel Introduction (GA-2AIEV2-RH)



2-4-2 : I/O Back Panel Introduction (GA-2AIEV-RH/GA-2AIEV3-RH)

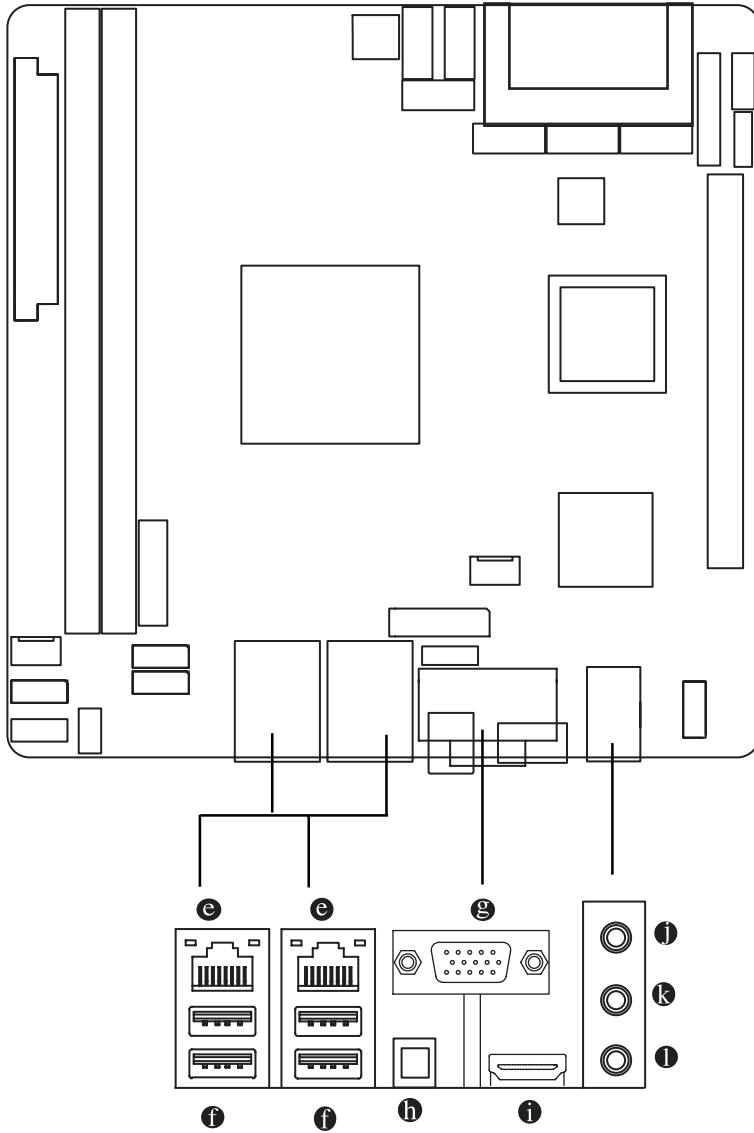

GA-2AIEV-RH/GA-2AIEV2-RH/GA-2AIEV3-RH Motherboard

a / b / c YPbPr Ports

The "Y," "Pb" and "Pr" are sets of three inputs or outputs on better video equipment and TVs. Blue port represents Pb port, Red represents Pr port, and Green represent Y port. Connect the YPbPr cable to these three ports.

i COAXIAL (SPDIF Out)

The SPDIF coaxial output port is capable for providing digital audio to external speakers or compressed AC3 data to an external Dolby Digital Decoder via a coaxial cable.

e LAN Port

The LAN port provides Internet connection of Gigabit Ethernet with data transfer speeds of 10/100/1000Mbps.

f USB

Before you connect your device(s) into USB connector(s), please make sure your device(s) such as USB keyboard, mouse, scanner, zip, speaker...etc. have a standard USB interface. Also make sure your OS supports USB controller. If your OS does not support USB controller, please contact OS vendor for possible patch or driver updated. For more information please contact your OS or device(s) vendors.

g VGA Port

Connect the monitor cable to this port.

h SPDIF Out (OPTICAL)

The SPDIF optical output port is capable for providing digital audio to external speakers or compressed AC3 data to an external Dolby Digital Decoder via an optical cable.

i HDMI Port

The HDMI (High-Definition Multimedia Interface) provides an all-digital audio/video interface to transmit the uncompressed audio/video signals and is HDCP compliant. Connect the HDMI audio/video device to this port. The HDMI Technology can support a maximum resolution of 1920x1080p but the actual resolutions supported depend on the monitor being used.



- After installing the HDMI device, make sure the default device for sound playback is the HDMI device. (The item name may differ by operating system. Refer the figures below for details.), and enter BIOS Setup, then set Onboard VGA output connect to D-SUB/HDMI under Advanced BIOS Features.
- Please note the HDMI audio output only supports AC3, DTS and 2-channel-LPCM formats. (AC3 and DTS require the use of an external decoder for decoding.)

In Windows XP, select Start>Control Panel>Sounds and Audio Devices>Audio, set the Default device for sound playback to Realtek HDA HDMI Out.



GA-2AIEV-RH/GA-2AIEV2-RH/GA-2AIEV3-RH Motherboard

In Windows Vista, select Start>Control Panel>Sound, select Realtek HDMI Output and then click Set Default.



- ❶ **Line In**
The default Line In jack. Devices like CD-ROM, walkman etc. can be connected to Line In jack.
- ❷ **Line Out (Front Speaker Out)**
The default Line Out (Front Speaker Out) jack. Stereo speakers, earphone or front surround speakers can be connected to Line Out (Front Speaker Out) jack.
- ❸ **MIC In**
The default MIC In jack. Microphone must be connected to MIC In jack.

LAN LED Description



Name	Color	Condition	Description
LED1	Yellow	BLINK	LAN Access
	-	OFF	Idle
LED2	-	OFF	10Mbps connection
	-	OFF	Port identification with 10 Mbps connection
	Green	ON	100Mbps connection
	Orange	ON	1Gbps connection

2-5: Connectors Introduction

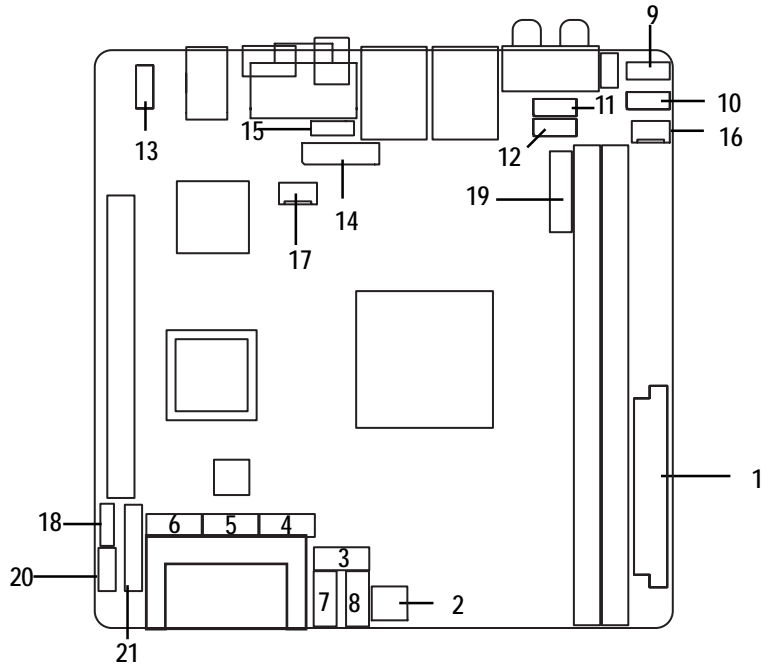

- | | |
|--|-------------------------------------|
| 1. ATX | 13. F_AUDIO1 |
| 2. ATX_12V1 | 14. LVDS_CON |
| 3. SATAII0_1 (SATA cable connector) | 15. BLIGHT_CON |
| 4. SATAII0_2 (SATA cable connector) | 16. CPU_FAN1 |
| 5. SATAII0_3 (SATA cable connector) | 17. SYS_FAN1 |
| 6. SATAII0_4 (SATA cable connector) | 18. LPC |
| 7. SATAII0_5 (SATA cable connector) | 19. LED_CON |
| 8. SATAII0_6 (SATA cable connector) | 20. F_Panel (Front Panel connector) |
| 9. COMA1 | 21. BATTTERY |
| 10. COMB1 | |
| 11. F_USB2 (Fornt USB cable connector) | |
| 12. F_USB1 (Fornt USB cable connector) | |

1/2/3) ATX/ATX_12V1 (24-pin/4-pin ATX power connectors)

With the use of the power connector, the power supply can supply enough stable power to all the components on the motherboard. Before connecting the power connector, please make sure that all components and devices are properly installed. Align the power connector with its proper location on the motherboard and connect tightly.

The ATX_12V power connector mainly supplies power to the CPU. If the ATX_12V power connector is not connected, the system will not start.

Caution! Please use a power supply that is able to support the system voltage requirements. It is recommended that a power supply that can withstand high power consumption be used (300W or greater). If a power supply is used that does not provide the required power, the result can lead to an unstable system or a system that is unable to start. If you use a power supply that provides a 24-pin ATX power connector, please remove the small cover on the power connector on the motherboard before plugging in the power cord; otherwise, please do not remove it.

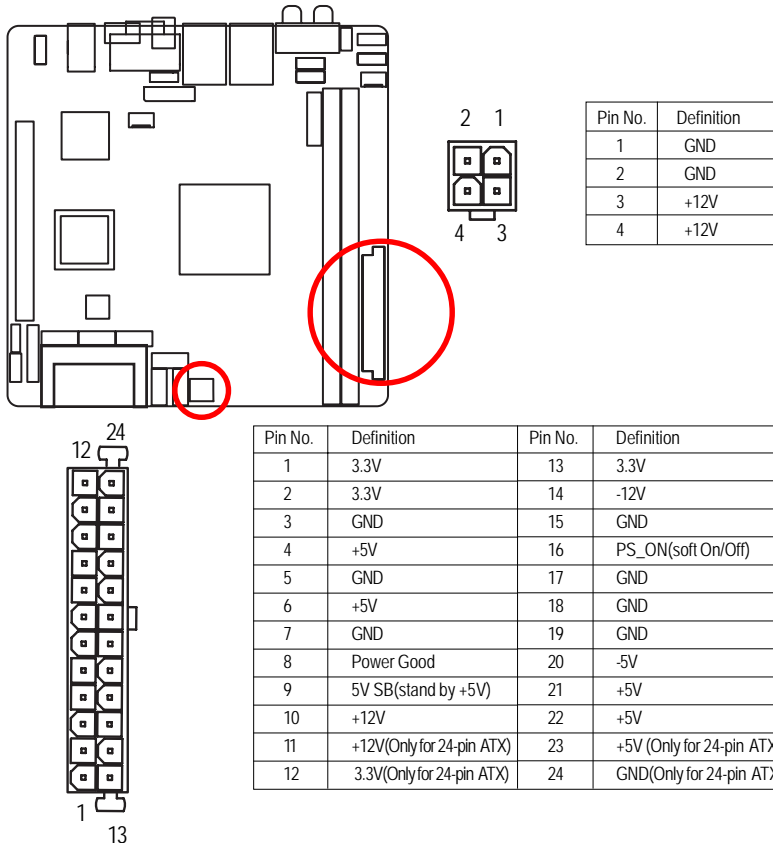

GA-2AIEV-RH/GA-2AIEV2-RH/GA-2AIEV3-RH Motherboard

3/ 4/ 5/ 6/ 7/ 8) SATAII0_1-6 (Serial ATA cable connectors)

SATA 3Gb/s can provide up to 300MB/s transfer rate. Please refer to the BIOS setting for the SATA 3Gb/s and install the proper driver in order to work properly.

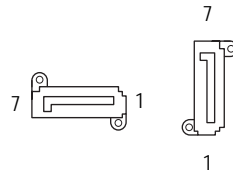
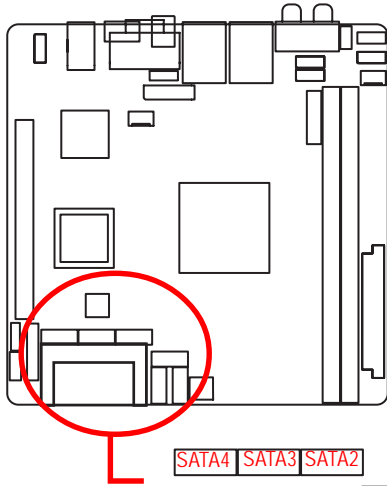

Pin No.	Definition
1	GND
2	TXP
3	TXN
4	GND
5	RXN
6	RXP
7	GND

SATA4 | SATA3 | SATA2

SATA1
SATA5
SATA6

9/ 10) COMA1/COMB1

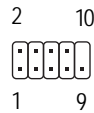
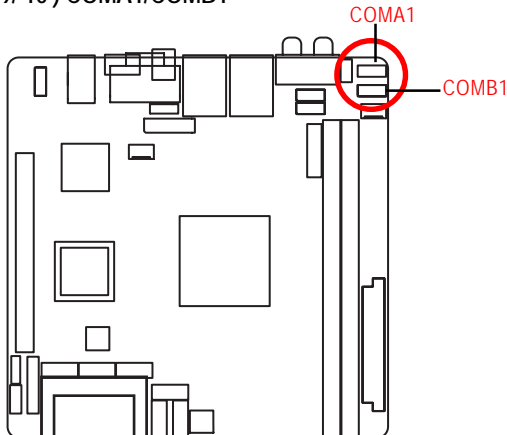

Pin No.	Definition
1	ND CD-
2	NSIN
3	NSOUT
4	NDTR-
5	GND
6	NDSR-
7	NRTS-
8	NCTS-
9	NRI-
10	No Pin

11/12) F_USB1/2 (Front USB cable connectors)

Be careful with the polarity of the front USB connector. Check the pin assignment carefully while you connect the front USB cable, incorrect connection between the cable and connector will make the device unable to work or even damage it. For optional front USB cable, please contact your local dealer.

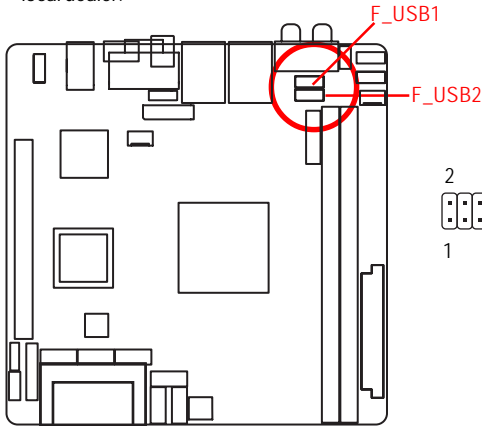

Pin No.	Definition
1	Power (5V)
2	Power (5V)
3	USB Dx-
4	USB Dy-
5	USB Dx+
6	USB Dy+
7	GND
8	GND
9	No Pin
10	NC

13) F_AUDIO1 (Front AUDIO connector)

If you want to use Front Audio connector, you must remove 5-6, 9-10 Jumper. In order to utilize the front audio header, your chassis must have front audio connector. Also please make sure the pin assignment on the cable is the same as the pin assignment on the MB header. To find out if the chassis you are buying support front audio connector, please contact your dealer.

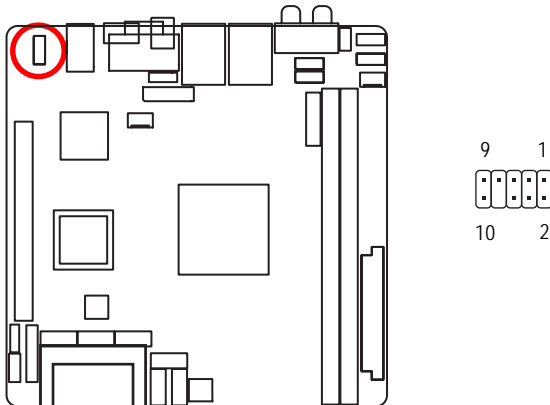

Pin No.	Definition
1	MIC_L
2	GND
3	MIC_R
4	-ACZ_DEC
5	Line_R
6	GND
7	Faudio_JD
8	No Pin
9	Line_L
10	GND

14) LVDS connector

LVDS stands for Low-voltage differential signaling, which uses high-speed analog circuit techniques to provide multigigabit data transfers on copper interconnects and is a generic interface standard for high-speed data transmission.

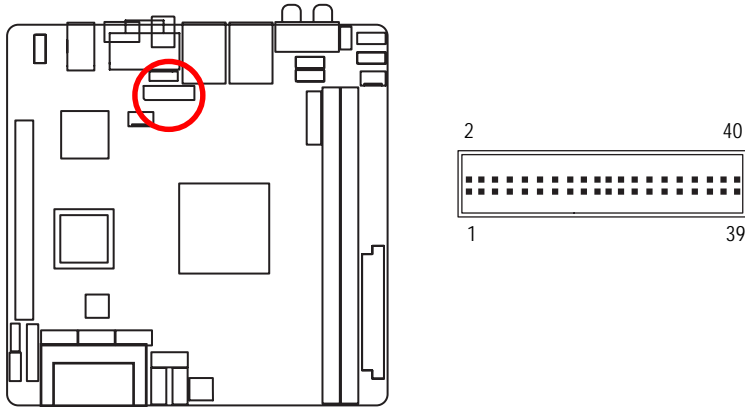

Pin No.	Definition	Pin No.	Definition
1	GND	21	LVDS_TX_U0-
2	+3.3V	22	LVDS_TX_U0+
3	+3.3V	23	LVDS_TX_U1-
4	+3.3V	24	LVDS_TX_U1+
5	+3.3V	25	LVDS_TX_U2-
6	+3.3V	26	LVDS_TX_U2+
7	NC	27	LVDS_TX_CLKU-
8	EDID CLK	28	LVDS_TX_CLKU+
9	EDID DATA	29	LVDS_TX_U3-
10	NC	30	LVDS_TX_U3+
11	LVDS_TX_L0-	31	NC
12	LVDS_TX_L0+	32	NC
13	LVDS_TX_L1-	33	+5V
14	LVDS_TX_L1+	34	+5V
15	LVDS_TX_L2-	35	+5V
16	LVDS_TX_L2+	36	NC
17	LVDS_TX_CLK-	37	NC
18	LVDS_TX_CLK+	38	GND
19	LVDS_TX_L3-	39	GND
20	LVDS_TX_L3+	40	GND

15) BLIGHT_CON (LVDS panel control connector)

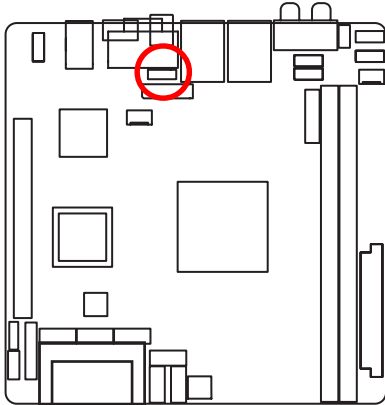

Pin No.	Definition
1	+12V
2	+5V
3	NC
4	BL ADJUST
5	BL ENABLE
6	GND

16/17) CPU_FAN1/SYS_FAN1 (CPU fan/System fan cable connectors)

The cooler fan power connector supplies a +12V power voltage via a 3-pin/4-pin(CPU_FAN) power connector and possesses a foolproof connection design.

Most coolers are designed with color-coded power connector wires. A red power connector wire indicates a positive connection and requires a +12V power voltage. The black connector wire is the ground wire (GND).

Remember to connect the CPU/system fan cable to the CPU_FAN/SYS_FAN connector to prevent CPU damage or system hanging caused by overheating.

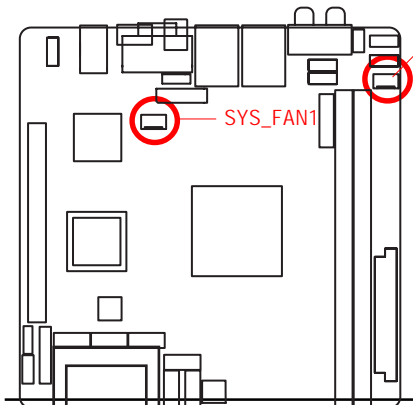

Pin No.	Definition
1	GND
2	12V
3	Sense
4	Control

GA-2AIEV-RH/GA-2AIEV2-RH/GA-2AIEV3-RH Motherboard

18) LPC (LPC connector)

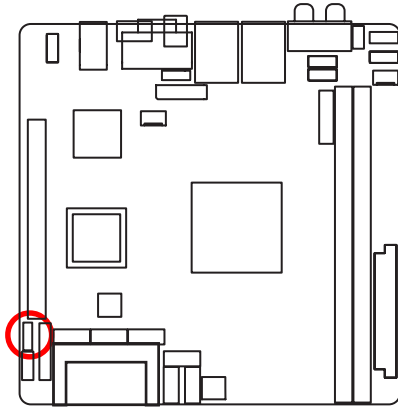

Pin No.	Definition
1	FWH33
2	-A_RST
3	-LFRAME
4	LAD3
5	LAD2
6	LAD1
7	LAD0
8	VCC3
9	GND
10	GND

19) BATTERY

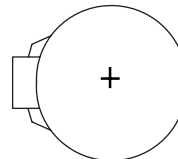
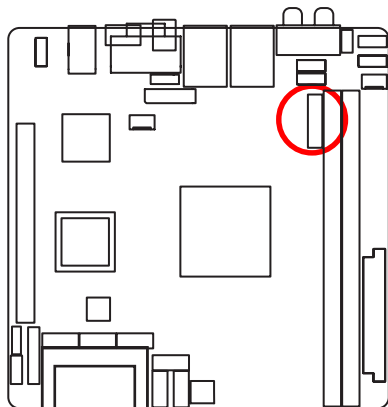

CAUTION

- ❖ Danger of explosion if battery is incorrectly replaced.
- ❖ Replace only with the same or equivalent type recommended by the manufacturer.
- ❖ Dispose of used batteries according to the manufacturer's instructions.

If you want to erase CMOS...

1. Turn OFF the computer and unplug the power cord.
2. Remove the battery, wait for 30 second.
3. Re-install the battery.
4. Plug the power cord and turn ON the computer.

20) F_Panel (2X5 Pins Front Panel connector)

Please connect the power LED, PC speaker, reset switch and power switch of your chassis front panel to the F_PANEL connector according to the pin assignment above.

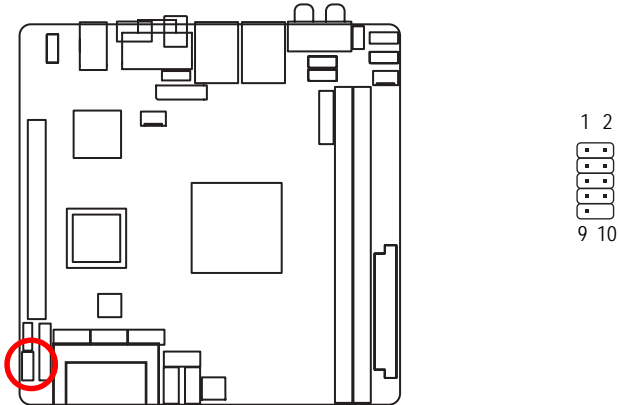

Pin No.	Signal Name	Description
1.	HDD_LED+	Hard Disk LED Signal anode (+)
2.	POWER_LED+	Power LED Signal anode (+)
3.	HD_LED-	Hard Disk LED Signal cathode(-)
4.	POWER_LED-	Power LED Signal cathode(-)
5.	GND	Ground
6.	POWER_SW+	Power Button Signal anode (+)
7.	RES	Reset Button
8.	GND	Ground
9.	NC	No connect
10.	NC	Pin removed

GA-2AIEV-RH/GA-2AIEV2-RH/GA-2AIEV3-RH Motherboard

21) LED_CON (Windows Home Server Front Panel connector)

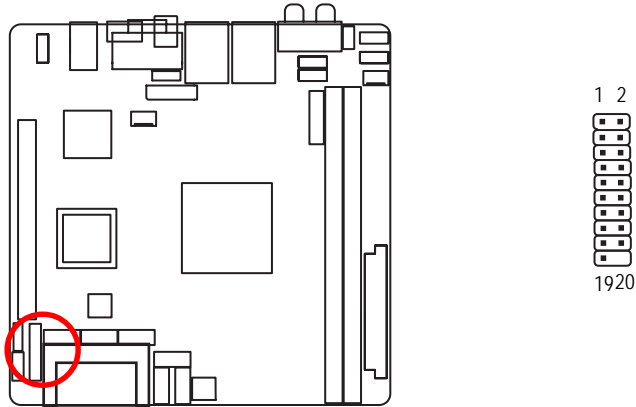

Pin No.	Signal Name	Description
1.	Power_LED+	Power LED Signal anode (+)
2.	Power_LED-	Power LED Signal cathode(-)
3.	BOOT_LED+	Boot Disk LED Signal anode (+)
4.	BOOT_LED-	Boot Disk LED Signal cathode(-)
5.	HDD1_LED+	Hard Disk1 Status Signal anode (+)
6.	HDD1_LED-	Hard Disk1 Status Signal cathode(-)
7.	HDD2_LED+	Hard Disk2 Status Signal anode (+)
8.	HDD2_LED-	Hard Disk2 Status Signal cathode(-)
9.	HDD2_LED+	Hard Disk3 Status Signal anode (+)
10.	HDD3_LED-	Hard Disk3 Status Signal cathode(-)
11.	HDD4_LED+	Hard Disk4 Status Signal anode (+)
12.	HDD4_LED-	Hard Disk4 Status Signal cathode(-)
13.	L12	LAN Active LED Signal anode (+)
14.	LINK_LED-	LAN Active LED Signal cathode(-)
15.	LED_100_P	LAN Speed LED Signal anode (+)
16.	LED_1000_P	LAN Speed LED Signal cathode(-)
17.	GND	Ground
18.	N C	No connect
19.	GND	Ground
20.	N C	Pin removed

2-6: Block Diagram

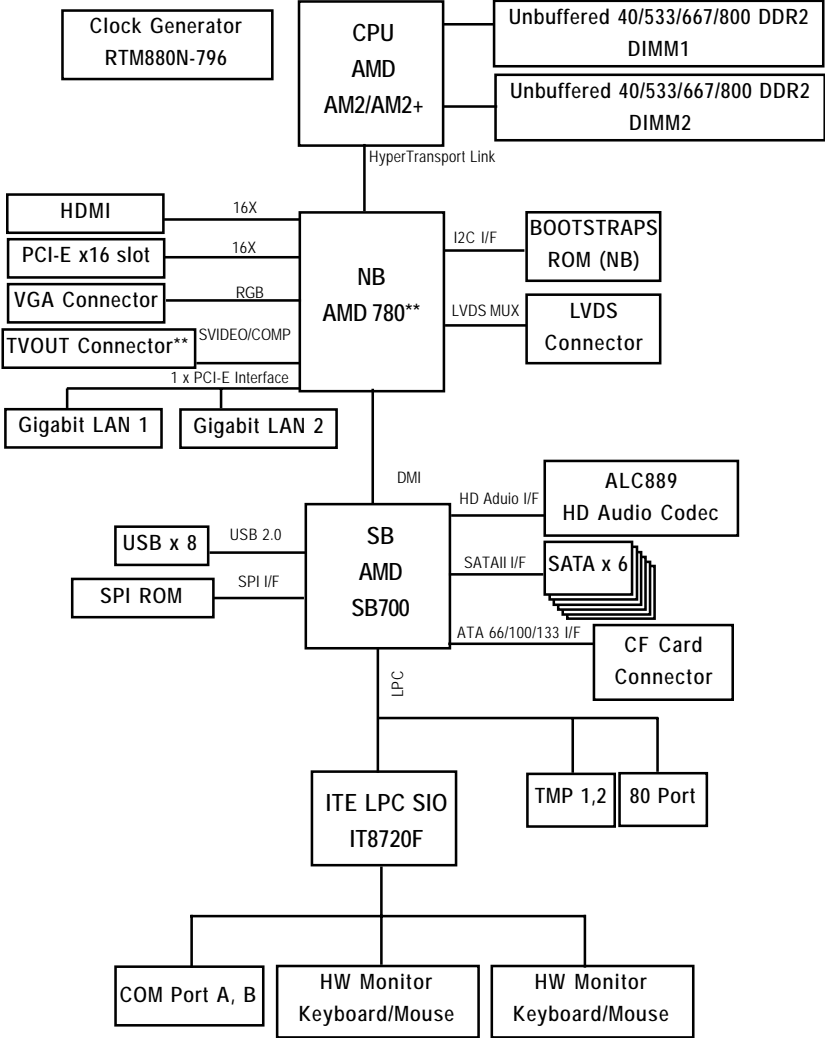

****Note****
GA-2AIEV-RH: AMD 780MN
GA-2AIEV2-RH: AMD 780M
GA-2AIEV3-RH: AMD 780E
TVOUT connector device only for GA-2AIEV2-RH

Chapter 3 BIOS Setup

BIOS (Basic Input and Output System) includes a CMOS SETUP utility which allows user to configure required settings or to activate certain system features.

The CMOS SETUP saves the configuration in the CMOS SRAM of the motherboard.

When the power is turned off, the battery on the motherboard supplies the necessary power to the CMOS SRAM.

ENTERING SETUP

When the power is turned on, press the <F2> button during the BIOS POST (Power-On Self Test) will take you to the CMOS SETUP screen. You can enter the BIOS setup screen by pressing "Ctrl + F1".

CONTROL KEYS

<↑>	Move to previous item
<↓>	Move to next item
<←>	Move to the item in the left hand
<→>	Move to the item in the right hand
<Esc>	Main Menu - Quit and not save changes into CMOS Status Page Setup Menu and Option Page Setup Menu - Exit current page and return to Main Menu
<+/PgUp>	Increase the numeric value or make changes
<-/PgDn>	Decrease the numeric value or make changes
<F1>	General help, only for Status Page Setup Menu and Option Page Setup Menu
<F2>	Reserved
<F3>	Reserved
<F4>	Reserved
<F6>	Reserved
<F7>	Reserved
<F8>	Reserved
<F9>	Load the Optimized Defaults
<F10>	Save all the CMOS changes, only for Main Menu

GETTINGHELP

Main Menu

The on-line description of the highlighted setup function is displayed at the bottom of the screen.

Status Page Setup Menu / Option Page Setup Menu

Press F1 to pop up a small help window that describes the appropriate keys to use and the possible selections for the highlighted item. To exit the Help Window press <Esc>.

Select the **Load Setup Defaults** item in the BIOS Exit Setup menu when somehow the system is not stable as usual. This action makes the system reset to the default settings for stability.

- **Main**

This setup page includes all the items in standard compatible BIOS.

- **Advanced**

This setup page includes all the items of Phoenix BIOS special enhanced features.
(ex: Auto detect fan and temperature status, automatically configure hard disk parameters.)

- **TPM State**

This setup page provide TPM state configuration

- **Security**

Change, set, or disable password. It allows you to limit access the system and setup.

- **Boot**

This setup page include all the items of first boot function features.

- **Exit**

There are five options in this selection: Exit Saving Changes, Exit Discarding Changes, Load Optimal Defaults, Load Failsafe Defaults, and Discard Changes.

Main

Once you enter Phoenix BIOS Setup Utility, the Main Menu (Figure 1) will appear on the screen. Use arrow keys to select among the items and press <Enter> to accept or enter the sub-menu.

PhoenixBIOS Setup Utility					
Main	Advanced	Security	TPM State	Boot	Exit
System Time	[19:04:035]			Item Help	
System Date	[04/11/2008]				
▶ SATA Port 1	[None]				
▶ SATA Port 2	[None]				
▶ SATA Port 3	[None]				
▶ SATA Port 4	[None]				
▶ SATA Port 5	[None]				
▶ SATA Port 6	[None]				
Halt On	[All, But Keyboard]				
System Memory	633KB				
Extended Memory	915456KB				
F1 Help	↑↓ Select Item	+/- Change Values		F9 Setup Defaults	
Esc Exit	↔ Select Menu	Enter Select Sub-Menu		F10 Save and Exit	

Figure 1: Main

🔑 System Time

The time is calculated based on the 24-hour military time clock. Set the System Time (HH:MM:SS)

🔑 System Date

Set the System Date. Note that the "Day" automatically changed after you set the date. (Weekend: DD: MM: YY) (YY: 1099-2099)

☞ **Slave/SATA Port 1/2/3/4/5/6**

The category identifies the types of Serial SATA hard disk from drive 1 to 6 that has been installed in the computer. System will automatically detect HDD type.

Note that the specifications of your drive must match with the drive table. The hard disk will not work properly if you enter improper information for this category.

Hard drive information should be labeled on the outside device casing. Enter the appropriate option based on this information.

▶▶ **TYPE**

1-39: Predefined types.

Users: Set parameters by User.

Auto: Set parameters automatically. (Default setting)

CD-ROM: Use for ATAPI CD-ROM drives or double click [Auto] to set all HDD parameters automatically.

ATAPI Removable: Removable disk drive is installed here.

▶▶ **Multi-Sector Transfer**

This field displays the information of Multi-Sector Transfer Mode.

Disabled: The data transfer from and to the device occurs one sector at a time.

Auto: The data transfer from and to the device occurs multiple sectors at a time if the device supports it.

- ▶▶ **LBA Mode** This field shows if the device type in the specific IDE channel support LBA Mode.
- ▶▶ **32-Bit I/O** Enable this function to maximize the IDE data transfer rate.
- ▶▶ **Transfer Mode** This field shows the information of Transfer Mode.
- ▶▶ **Ultra DMA Mode** This field displays the DMA mode of the device in the specific IDE channel.

☞ **Halt On**

The category determines whether the computer will stop if an error is detected during power up.

- ▶▶ No Errors The system boot will not stop for any error that may be detected and you will be prompted.
- ▶▶ All, But Keyboard The system boot will not stop for a keyboard error; it will stop for all other errors. (Default setting)
- ▶▶ All Errors Whenever the BIOS detects a non-fatal error the system will be stopped.

☞ **System Memory**

The POST of the BIOS will determine the amount of system memory installed in the system.

☞ **Extended Memory**

The BIOS determines how much extended memory is present during the POST.

This is the amount of memory located above 1 MB in the CPU's memory address map.

Advanced

About This Section: Advanced

With this section, allowing user to configure your system for advanced operation. User can set the System Management, CPU Feature, Advanced Chipset Control, I/O Device Configuration, Power Feature, and Hardware Monitor.

PhoenixBIOS Setup Utility				
Main	Advanced	Security	IPM State	Boot Exit
<ul style="list-style-type: none"> ▶ System Management ▶ CPU Feature ▶ Advanced Chipset Control ▶ I/O Device Configuration ▶ Power Feature] ▶ Hardware Monitor 			Item Help	
Quick Boot Mode		[Enabled]		
Boot-time Diagnostic Screen		[Enabled]		
Summary Screen		[Disabled]		
Local Bus IDE adapter		[Both]		
OnChip SATA		[Enabled]		
SATA Class ID		[IDE native class]		
SATA IDE Combined mode		[Enabled]		
PATA Channel Config		[SATA as secondary]		
ACHI ROM POST delay		[3 Seconds]		
USB Host Controller		[Enabled]		
USB BIOS Legacy Support		[Enabled]		
Gigabit LAN		[Enabled]		
LOM Boot ROM		Disabled]		
F1 Help	↑↓	Select Item	+/-	Change Values
F9 Setup Defaults				
Esc Exit	↔	Select Menu	Enter	Select Sub-Menu
F10 Save and Exit				

Figure 2: Advanced

System Information

PhoenixBIOS Setup Utility				
Advanced				
System Management				Item Help
BIOS Version:	2AIEV-E5a			
Product Name:	Bluefin			
BIOS Date (mm/dd/yy)	12/09/08			
CPU Type	AMD Phenom(tm) 9350e Quad			
CPU Speed	200MHz			
AGESA Version:	03.01.09			
NB CIM Version:	4.3.0			
SB CIM Version:	4.0.0			
Memory DIMM1:	Not Installed			
Memory DIMM2:	10024MB			
GBIA Module Version	00.02			
F1 Help	↑↓	Select Item	+/- Change Values	F9 Setup Defaults
Esc Exit	↔	Select Menu	Enter Select Sub-Menu	F10 Save and Exit

Figure 2-1: System Information

System Information

This category includes the system information of BIOS Version, Product Name, BIOS Build Date, CPU Type, CPU Speed, AGESA version, Memory DIMM1/ DIMM2, NB and SB CIM version, and GBIA Module Version.

CPU Feature

PhoenixBIOS Setup Utility			
Advanced			
CPU Features			Item Help
CPU Type	AMD Phenom(tm) 9350e Quad		
CPU Speed	200MHz		
L2 Cache Size:	1024KB		
PowerNow! Technology	[Enabled]		
F1 Help	↑↓ Select Item	+/- Change Values	F9 Setup Defaults
Esc Exit	↔ Select Menu	Enter Select Sub-Menu	F10 Save and Exit

Figure 2-2: CPU Feature

☞ CPU Type

This item displays the information of installed CPU type.

☞ CPU Speed

This item displays the information of CPU speed.

☞ L2 Cache Size

This item displays the information of CPU L2 cache size.

☞ PowerNow! Technology

- ▶▶ Enabled Enable Power Now Technology.
- ▶▶ Disabled Disable Power Now Technology.

Advanced Chipset Control

PhoenixBIOS Setup Utility	
Advanced	
Advanced Chipset Control	Item Help
▶ Internal Graphics Configuration GFX Dual Slot Configuration [Disabled] GPP Slots Power Limit, W [25] NB Azalaza [Enabled] Aza Snoop [Enabled]	
F1 Help	↑↓ Select Item
Esc Exit	↔ Select Menu
+/- Change Values	Enter Select Sub-Menu
F9 Setup Defaults	F10 Save and Exit

Figure 2-3: Advanced Chipset Control

☞ Internal Graphics Configuration

☞ Internal Graphic Mode

This item allows user to select the memory mode used for internal graphics device.

▶▶UMA Define UMA as internal graphic mode.

▶▶Disabled Disabled this function.

☞ UMA Frame Buffer Size

This item allows user to choose the UMA frame buffer size for internal graphics.

▶▶Options 32MB, 64MB, 128MB,256MB, 512MB, Auto. Default setting is 128MB.

☞ GFX Engine Clock

This item allows user to control the internal GFX engine clock override function.

▶▶Options 0 for Auto. Default setting is 0.

☞ Lane 0-3/Lane 4-7/Lane 8-11/Lane 12-15

PCI-E Lanes setting.

- Options Disabled, Port A, Port B, DDI1, DDI2. Default setting is disabled.

☞ **Bank Mapping Control**

- Auto Set the Bank Mapping to Auto mode. (Default setting)
- Manual Set the Bank Mapping to Manual mode.

☞ **UMA Address Swizzle Control**

- Auto Set the UMA Address Swizzle Control to Auto mode. (Default setting)
- Manual Set the UMA Address Swizzle Control to Manual mode.

☞ **LCD Brightness Level**

- Options Level 0, Level 1, Level 2, Level 3, Level 4, Level 5, Level 6, Level 7, Level 8, Level , Level 9, Level 10, Level 11, Level 12, Level 13, Level 14, Level 15. Default setting is Level 9.

☞ **Light Sensor Support**

- Enabled Enable Light Sensor Support.
- Disabled Disable Light Sensor Support. (Default setting)

☞ **GFX Dual Slot Configuration**

- Auto Auto configuration.
- Enabled Enable GFX Dual Slot Configuration
- Disabled Disable GFX Dual Slot Configuration. (Default setting)

☞ **GPP Slots Power Limit, W**

Define the GPP Slots Power Limit, W.

☞ **NB Aza lia**

- Enabled Enable the NB audio function. (Default setting)
- Disabled Disable the NB audio function.

☞ **Aza Snoop**

- Enabled Enable Aza Snoop function. (Default setting)
- Disabled Disable Aza Snoop function.

I/O Device Configuration

PhoenixBIOS Setup Utility				
Advanced				
I/O Device Configuration			Item Help	
Serial Port A	[Auto]			
Serial Port B	[Auto]			
F1 Help	↑↓ Select Item	+/- Change Values	F9 Setup Defaults	
Esc Exit	⇌ Select Menu	Enter Select Sub-Menu	F10 Save and Exit	

Figure 2-4: I/O Device Configuration

Serial Port A

This allows users to configure serial port A by using this option.

- ▶▶Auto Auto detection. (Default setting)
- ▶▶Enabled Enable the configuration.
- ▶▶Disabled Disable the configuration.

Serial Port B

This allows users to configure serial port B by using this option.

- ▶▶Auto Auto detection. (Default setting)
- ▶▶Enabled Enable the configuration.
- ▶▶Disabled Disable the configuration.

Power Feature

PhoenixBIOS Setup Utility	
Advanced	
Power Features	Item Help
AC-LINK [Last State]	
Resume On Time [Off]	
Resume Time [00:0:00]	
Resume On Modem [Off]	
F1 Help ↑↓ Select Item +/- Change Values F9 Setup Defaults Esc Exit ⇄ Select Menu Enter Select Sub-Menu F10 Save and Exit	

Figure 2-5: Power Feature

☞ **AC-LINK**

This option provides user to set the mode of operation if an AC / power loss occurs.

- ▶▶ Stay Off Do not power on system when AC power is back.
- ▶▶ Last State Set system to the last state when AC power is removed. Do not power on system when AC power is back. (Default setting)
- ▶▶ Power On System power state when AC cord is re-plugged.

☞ **Resume On Time**

- ▶▶ On Enable alarm function to POWER ON system.
- ▶▶ Off Disable this function. (Default setting)

GA-2AIEV-RH/GA-2AIEV2-RH/GA-2AIEV3-RH Motherboard

☞ **Resume Time**

Set the specific resume time.

▶▶Time (hh: mm: ss) Alarm : (0~23) : (0~59) : (0~59)

☞ **Resume On Modem**

▶▶On Enable wake up the system when a incoming call is detected on your modem.

▶▶Off Disable this function. (Default setting)

Hardware Monitor

PhoenixBIOS Setup Utility	
Advanced	
Hardware Monitor	Item Help
CPU Temperature	34C / 093F
System Temperature	51C / 123F
▶ Fan Monitor	
▶ Voltage Monitor	
F1 Help	↑↓ Select Item
Esc Exit	↔ Select Menu
	+/- Change Values
	Enter Select Sub-Menu
	F9 Setup Defaults
	F10 Save and Exit

Figure 2-6: Hardware Monitor Feature

☞ CPU Temperature/System Temperature

▶▶ Detects and displays current system and CPU temperature automatically.

☞ CPU Fan/System Fan

▶▶ Detects and displays the current CPU/system fan speed status automatically

☞ Vcore1/1.8V/3.3V/12V

▶▶ Detects and displays the current system's voltage status automatically.

GA-2AIEV-RH/GA-2AIEV2-RH/GA-2AIEV3-RH Motherboard

PhoenixBIOS Setup Utility				
Main	Advanced	Security	TPM State	Boot Exit
<ul style="list-style-type: none"> ▶ System Management ▶ CPU Feature ▶ Advanced Chipset Control ▶ I/O Device Configuration ▶ Power Feature] ▶ Hardware Monitor 				Item Help
Quick Boot Mode		[Enabled]		
Boot-time Diagnostic Screen		[Enabled]		
Summary Screen		[Disabled]		
Local Bus IDE adapter		[Both]		
OnChip SATA		[Enabled]		
SATA Class ID		[IDE native class]		
SATA IDE Combined mode		[Enabled]		
PATA Channel Config		[SATA as secondary]		
ACHI ROM POST delay		[3 Seconds]		
USB Host Controller		[Enabled]		
USB BIOS Legacy Support		[Enabled]		
Gigabit LAN		[Enabled]		
LOM Boot ROM		Disabled]		
F1 Help	↑↓ Select Item	+/- Change Values	F9 Setup Defaults	
Esc Exit	↔ Select Menu	Enter Select Sub-Menu	F10 Save and Exit	

 **Quick Boot Mode**

Set this item to enable will allow to skip certain tests during booting. This will decrease the time needed to boot the system.

- ▶▶ Enabled Enable Quick Boot Mode. (Default setting)
- ▶▶ Disabled Disable Quick Boot Mode.

☞ **Boot-time Diagnostic Screen**

When this item is enabled, system will shows Diagnostic status when system boot.

- ▶▶ Enabled Enable Boot-time Diagnostic function.
- ▶▶ Disabled Disable Boot-time Diagnostic function. (Default setting)

☞ **Summary Screen**

Display system configuration on boot.

- ▶▶ Enabled Enable Summary Screen function. (Default setting)
- ▶▶ Disabled Disable Summary Screen function.

☞ **Local Bus IDE adapter**

- ▶▶ Primary Enable primary integrated local bus IDE adapter.
- ▶▶ Secondary Enable secondary integrated local bus IDE adapter.
- ▶▶ Both Enable primary and secondary integrated local bus IDE adapter.
(Default setting)
- ▶▶ Disabled Disable integrated local bus IDE adapter.

☞ **OnChip SATA**

- ▶▶ Enabled Enable onboard SATA device. (Default setting)
- ▶▶ Disabled Disable onboard SATA device.

☞ **SATA Class ID**

Change the class ID for SATA device.

- ▶▶ Options IDE native class, Raid class, ACHI class, IDE Legacy class,
IDE-ACHI class, HyperFlash class, IDE-HyperFlash class.
Default setting is IDE native class.

☞ **SATAIDE Combined Mode**

- ▶▶ Enabled Enable SATA IDE Combined Mode. (Default setting)
- ▶▶ Disabled Disable SATA IDE Combined Mode.

☞ **PATA Channel Config**

- ▶▶ Options SATA as secondary, SATA as primary.
Default setting is SATA as secondary.

GA-2AIEV-RH/GA-2AIEV2-RH/GA-2AIEV3-RH Motherboard

☞ **ACHIROMPOST delay**

Select SATA option ROM POST delay.

- ▶▶ Options Disabled, 1 seconds, 2 seconds, 3 seconds, 4seconds, 5 seconds, 6 seconds, 7 seconds.

☞ **USB Host Controller**

- ▶▶ Enabled Enable onboard USB device. (Default setting)
- ▶▶ Disabled Disable onboard USB device.

☞ **USB BIOS Legacy Support**

This option allows user to function support for legacy USB keyboard and mice.

- ▶▶ Enabled Enable support for legacy USB. (Default setting)
- ▶▶ Disabled Disable support for legacy USB.

☞ **Gigabit Lan**

- ▶▶ Enabled Enable onboard Lan device. (Default setting)
- ▶▶ Disabled Disable onboard Lan device.

☞ **LOMBootROM**

- ▶▶ Enabled Support Lan On Motherboard boot.
- ▶▶ Disabled Faster stand alone boot. (Default setting)S

Security

About This Section: Security

In this section, user can set either supervisor or user passwords, or both for different level of password securities. In addition, user also can set the virus protection for boot sector.

PhoenixBIOS Setup Utility				
Main	Advanced	Security	TPM State	Boot Exit
Supervisor Password Is:		Clear	Item Help	
User Password Is:		Clear		
Set Supervisor Password		[Enter]		
Set User Password		[Enter]		
Password On Boot		[Disabled]		
TPM Support		[Enabled]		
F1 Help	↑↓ Select Item	+/- Change Values	F9 Setup Defaults	
Esc Exit	↔ Select Menu	Enter Select Sub-Menu	F10 Save and Exit	

Figure 3: Security

🔑 Set Supervisor Password

You can install and change this options for the setup menus. Type the password up to 6 characters in length and press <Enter>. The password typed now will clear any previously entered password from the CMOS memory. You will be asked to confirm the entered password. Type the password again and press <Enter>. You may also press <Esc> to abort the selection and not enter a specified password or press <Enter> key to disable this option.

🔑 Set User Password

You can only enter but do not have the right to change the options of the setup menus. When you select this function, the following message will appear at the center of the screen to assist you in creating a password.

Type the password up to 6 characters in length and press <Enter>. The password typed now will clear any previously entered password from the CMOS memory. You will be asked to confirm the entered password. Type the password again and press <Enter>. You may also press <Esc> to abort the selection and not enter a specified password.

GA-2AIEV-RH/GA-2AIEV2-RH/GA-2AIEV3-RH Motherboard

Password on boot

Password entering will be required when system on boot.

Please note that this item will be adjustable when supervision password is set.

- ▶▶ Enabled Requires entering password when system on boot.
- ▶▶ Disabled Disable this function. (Default setting)

TPMSupport

TPM, stands for Trusted Platform Module. A Trusted Platform Module provides function for secure generation of cryptographic keys, the ability to limit the use of cryptographic keys, as well as a hardware pseudo-random number generator.

- ▶▶ Enabled Enable TPM Support. (Default setting)
- ▶▶ Disabled Disable TPM Support.

TPM State

PhoenixBIOS Setup Utility					
Main	Advanced	Security	TPM State	Boot	Exit
Current TPM State:		Disabled & Deactivated		Item Help	
Change TPM State		[No Change]			
F1 Help	↑↓ Select Item	+/- Change Values	F9 Setup Defaults		
Esc Exit	⇄ Select Menu	Enter Select Sub-Menu	F10 Save and Exit		

Figure 4: TPM State

☞ **Current TPM State**

- ▶▶ Displays the current TPM State status.

☞ **Change TPM State**

- ▶▶ No Change No configuration on TPM State. (Default setting)
- ▶▶ Activated & Enabled Enable and activate TPM State.
- ▶▶ Disabled & Deactivated Disable and deactivate TPM State.
- ▶▶ Clear Clear the TPM stored information on the TPM.

Boot

PhoenixBIOS Setup Utility					
Main	Advanced	Security	TPM State	Boot	Exit
Boot priority order: 1: USB KEY: 2: USB FDC: 3: USB HDD: 4. IDE CD: 5.: USB CDROM: 6. PCI BEV: 7. IDE HDD: 8: Excluded from boot order: : USB ZIP :				Item Help	
F1 Help	↑↓ Select Item	+/- Change Values	F9 Setup Defaults		
Esc Exit	↔ Select Menu	Enter Select Sub-Menu	F10 Save and Exit		

Figure 5: Boot

🔗 Boot Priority Order

This field determines which type of device the system attempt to boot from after **PhoenixBIOS Post** completed. Specifies the boot sequence from the available devices. If the first device is not a bootable device, the system will seek for next available device.

Key used to view or configure devices:

Up and Down arrows select a device.

<+> and <-> moves the device up or down.

<f> and <r> specifies the device fixed or removable.

<x> exclude or include the device to boot.

<Shift + 1> Enable or disable a device.

<1-4> Loads default boot sequence.

Exit

PhoenixBIOS Setup Utility				
Main	Advanced	Security	TPM State	Boot Exit
Exit Saving Changes			Item Help	
Exit Discarding Changes				
Load Setup Defaults				
Discard Changes				
Save Changes				
F1 Help	↑↓ Select Item	+/- Change Values	F9 Setup Defaults	
Esc Exit	↔ Select Menu	Enter Select Sub-Menu	F10 Save and Exit	

Figure 6: Exit

About This Section: Exit

Once you have changed all of the set values in the BIOS setup menu, you should save your changes and exit BIOS setup program. Select “Exit” from the menu bar, to display the following sub-menu.

- Exit Saving Changes
- Exit Discarding Changes
- Load Setup Default
- Discard Changes
- Save Changes

☞ **Exit Saving Changes**

This option allows user to exit system setup with saving the changes.

Press <Enter> on this item to ask for the following confirmation message:

Pressing 'Y' to store all the present setting values tha user made in this time into CMOS.

Therefore, whenyou boot up your computer next time, the BIOS will re-configure your system according data in CMOS.

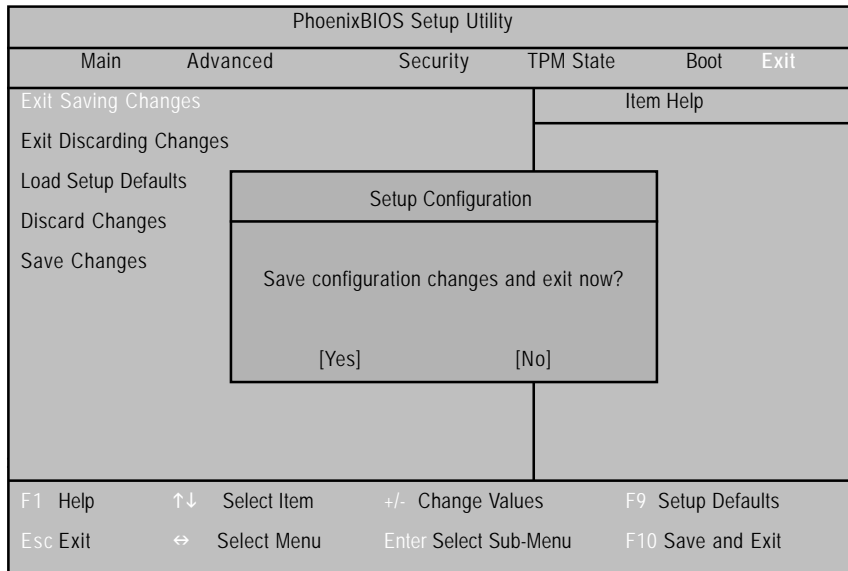

☞ **Exit Discarding Changes**

This option allows user to exit system setup without changing any previous settings values in CMOS. The previous selection remain in effect.

This will exit the Setup Utility and restart your computer when selecting this option.

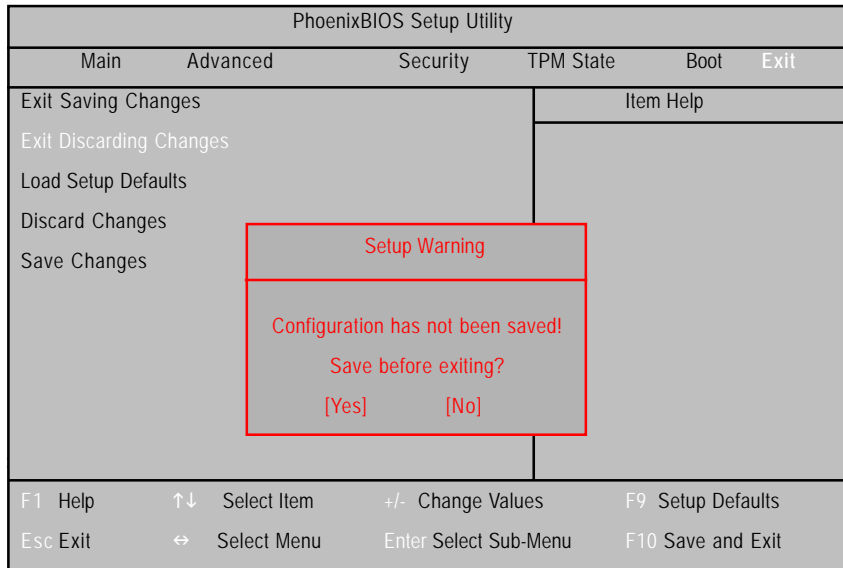

☞Load Setup Default

This option allows user to load default values for all setup items.

When you press <Enter> on this item, you will get a confirmation dialog box with a message as below:

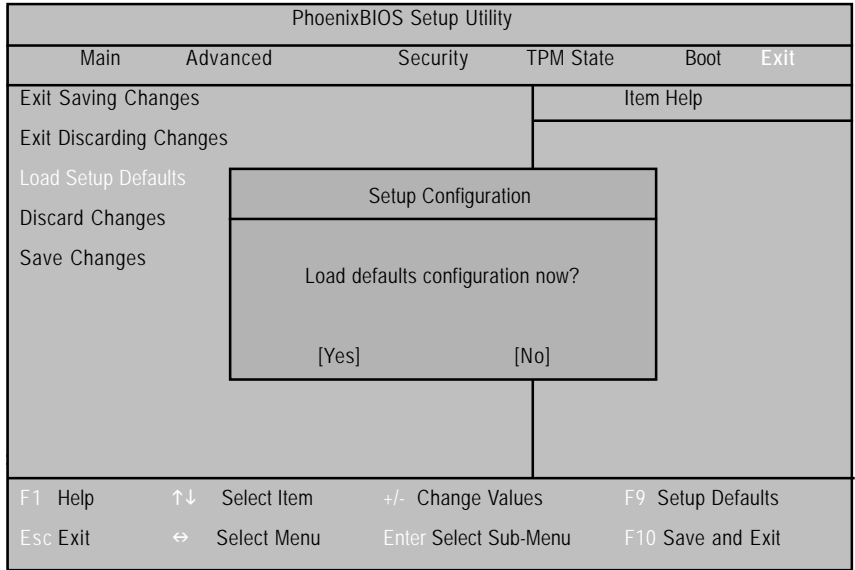

☞ **Discard Changes**

This option allows user to load previous values from CMOS for all setup item.

When you press <Enter> on this item, you will get a confirmation dialog box with a message as below:

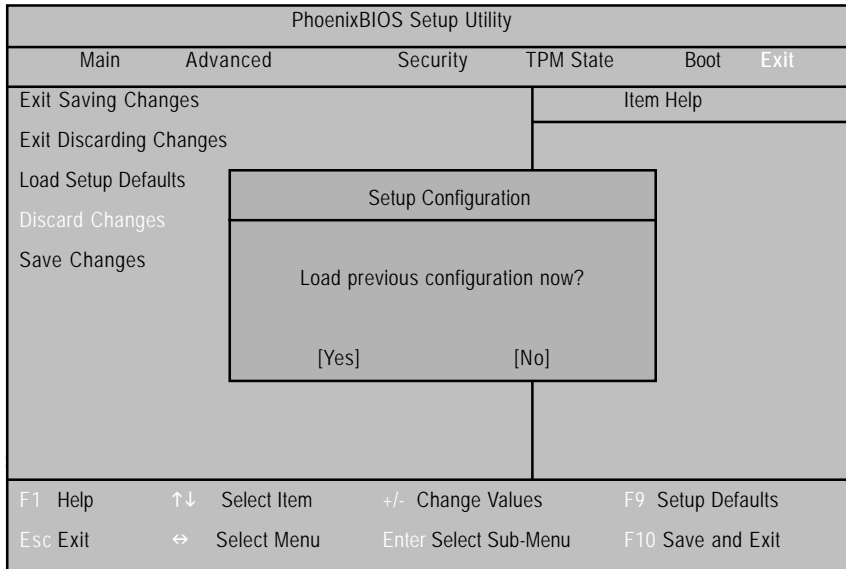

GA-2AIEV-RH/GA-2AIEV2-RH/GA-2AIEV3-RH Motherboard

☞ **Save Changes**

This option allows user to save setup data to CMOS.

When you press <Enter> on this item, you will get a confirmation dialog box with a message as below:

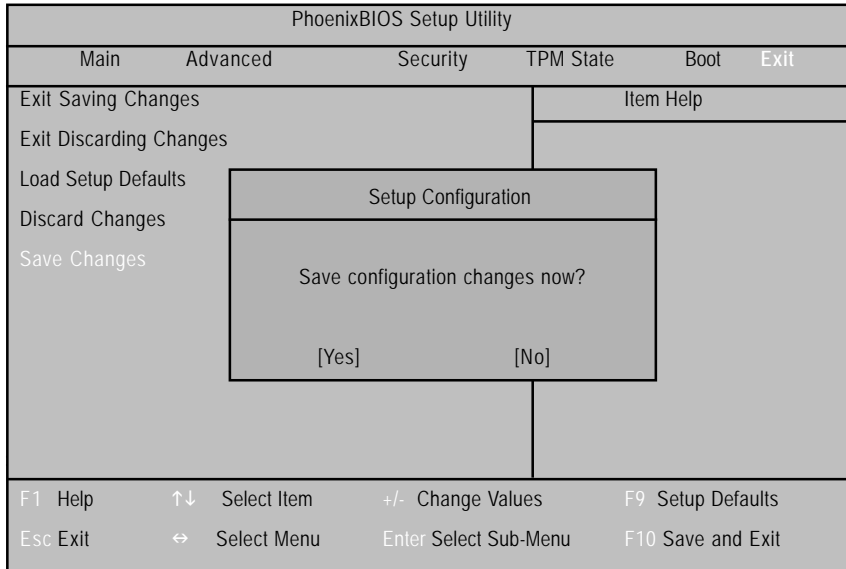

Press [Yes] to save setup data to CMOS.