

TO-264

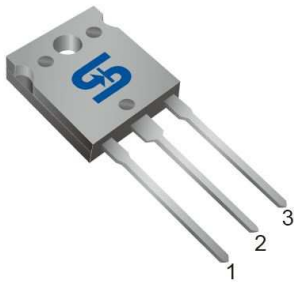

Pin Definition:

1. Gate
2. Collector
3. Emitter

PRODUCT SUMMARY

V_{CES} (V)	V_{GES} (V)	I_C (A)
1000	±20	60

General Description

The TSG60N100CE using proprietary trench design and advanced NPT technology, the 1000V NPT IGBT offers superior conduction and switching performances, high avalanche ruggedness and easy parallel operation. This device is well suited for the resonant or soft switching application such as induction heating, microwave oven, etc.

Features

- 1000V NPT Trench Technology
- High Speed Switching
- Low Conduction Loss

Ordering Information

Part No.	Package	Packing
TSG60N100CE C0	TO-264	25pcs / Tube

Block Diagram

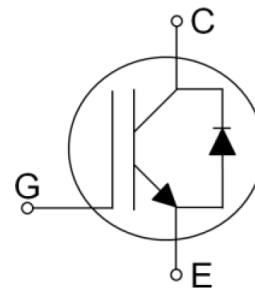

NPT Trench IGBT

Absolute Maximum Rating ($T_A=25^\circ\text{C}$ unless otherwise noted)

Parameter	Symbol	Limit	Unit	
Collector-Emitter Voltage	V_{CES}	1000	V	
Gate-Emitter Voltage	V_{GES}	±20	V	
Continuous Current	I_C	$T_C=25^\circ\text{C}$	60	A
		$T_C=100^\circ\text{C}$	42	A
Pulsed Collector Current *	I_{CM}	200	A	
Diode Continuous Forward Current ($T_C=100^\circ\text{C}$)	I_F	15	A	
Max Power Dissipation	P_D	$T_J=25^\circ\text{C}$	208	W
		$T_J=100^\circ\text{C}$	83	
Operating Junction Temperature	T_J	-55 to +150	$^\circ\text{C}$	
Storage Temperature Range	T_{STG}	-55 to +150	$^\circ\text{C}$	

* Repetitive rating: Pulse width limited by max. junction temperature

Thermal Performance

Parameter	Symbol	Limit	Unit
Thermal Resistance - Junction to Case	IGBT	0.6	°C/W
	DIODE	2.2	
Thermal Resistance - Junction to Ambient	$R\theta_{JA}$	25	

Electrical Specifications (T_C=25°C unless otherwise noted)

Parameter	Conditions	Symbol	Min	Typ	Max	Unit
Static						
Collector-Emitter Breakdown Voltage	V _{GE} = 0V, I _C = 1mA	BV _{CES}	1000	--	--	V
Zero Gate Voltage Collector Current	V _{CE} = 1000V, V _{GE} = 0V	I _{CES}	--	--	1	mA
Gate-Emitter Leakage Current	V _{GE} = 20V, V _{CE} = 0V	I _{GES}	--	--	±250	nA
Gate-Emitter Threshold Voltage	V _{GE} = V _{CE} , I _C = 60mA	V _{GE(TH)}	3.5	5.5	7.5	V
Collector-Emitter Saturation Voltage	V _{GE} = 15V, I _C = 60A, T _J = 25°C	V _{CE(SAT)}	--	2.1	2.5	V
	V _{GE} = 15V, I _C = 60A, T _J = 125°C	V _{CE(SAT)}	--	2.6	--	V
Dynamic						
Input Capacitance	V _{CE} = 30V, V _{GE} = 0V, f = 1.0MHz	C _{IES}	--	5600	--	pF
Output Capacitance		C _{OES}	--	150	--	
Reverse Transfer Capacitance		C _{RES}	--	115	--	
Switching						
Turn-On Delay Time	V _{CC} = 600V, I _C = 60A, R _G = 10Ω, V _{GE} = 15V Inductive Load, T _J = 25°C	t _{d(on)}	--	230	--	nS
Rise Time		t _r	--	210	--	
Turn-Off Delay Time		t _{d(off)}	--	1250	--	
Fall Time		t _f	--	120	230	mJ
Turn-On Switching Loss		E _{on}	--	14.5	22	
Turn-Off Switching Loss		E _{off}	--	7.0	11	
Total Switching Loss	E _{ts}	--	21.5	33		
Turn-On Delay Time	V _{CC} = 600V, I _C = 60A, R _G = 10Ω, V _{GE} = 15V Inductive Load, T _J = 125°C	t _{d(on)}	--	210	--	nS
Rise Time		t _r	--	260	--	
Turn-Off Delay Time		t _{d(off)}	--	1350	--	
Fall Time		t _f	--	160	--	mJ
Turn-On Switching Loss		E _{on}	--	16	24	
Turn-Off Switching Loss		E _{off}	--	8.0	12	
Total Switching Loss	E _{ts}	--	24	36		
Total Gate Charge	V _{CC} = 600V, I _C = 60A, V _{GE} = 15V	Q _g	--	270	405	nC
Gate-Emitter Charge		Q _{ge}	--	45	68	
Gate-Collector Charge		Q _{gc}	--	100	150	

Electrical Specifications of the DIODE ($T_c=25^\circ\text{C}$ unless otherwise noted)

Parameter	Conditions		Symbol	Min	Typ	Max	Unit
Diode Forward Voltage	$I_F = 60\text{A}$,	$T_J=25^\circ\text{C}$	V_{FM}	--	2.9	3.4	V
		$T_J=125^\circ\text{C}$		--	3.3	--	V
Reverse Recovery Time	$I_F = 60\text{A}$, $di/dt=200\text{A}/\mu\text{s}$	$T_J=25^\circ\text{C}$	t_{fr}	--	310	465	ns
		$T_J=125^\circ\text{C}$		--	320	--	
Reverse Recovery Current		$T_J=25^\circ\text{C}$	I_{fr}	--	34	51	A
		$T_J=125^\circ\text{C}$		--	35	--	
Reverse Recovery Charge		$T_J=25^\circ\text{C}$	Q_{fr}	--	5270	7900	nC
		$T_J=125^\circ\text{C}$		--	5600	--	

Electrical Characteristics Curve ($T_c = 25^\circ\text{C}$, unless otherwise noted)

Output Characteristics

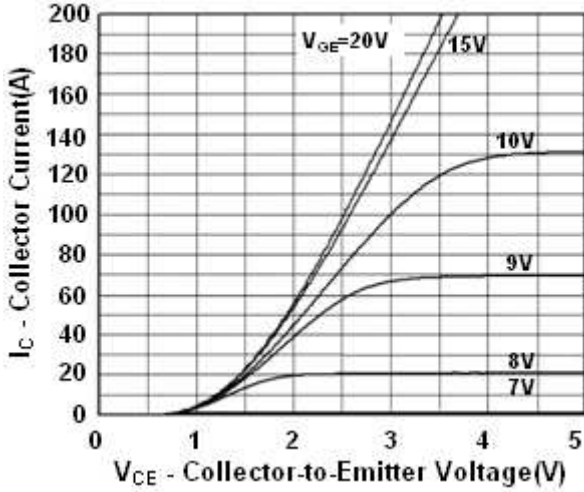

Saturation voltage characteristics

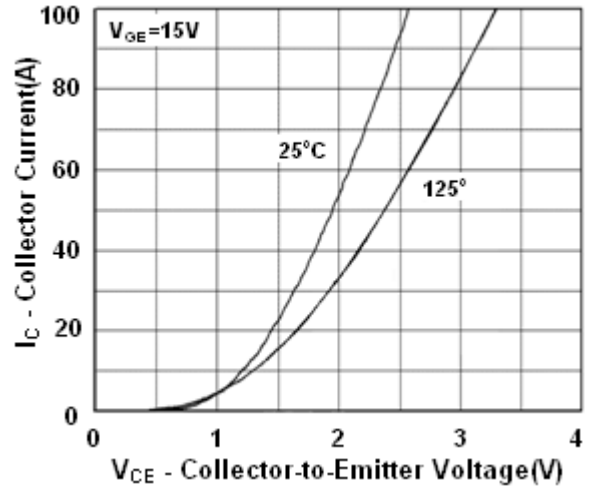

Saturation voltage vs. collector current

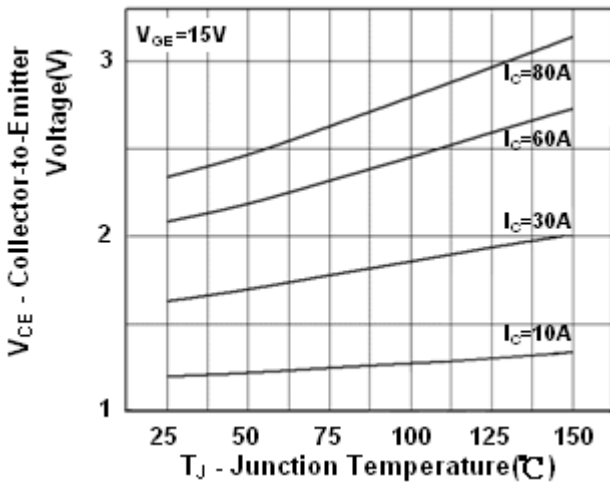

Saturation voltage vs. gate bias

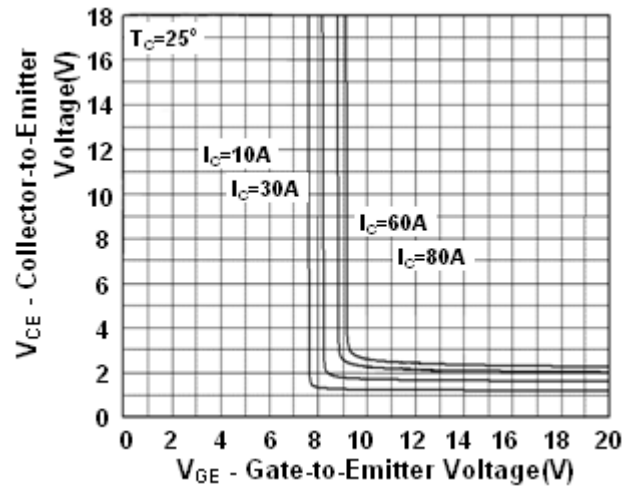

Saturation voltage vs. gate bias

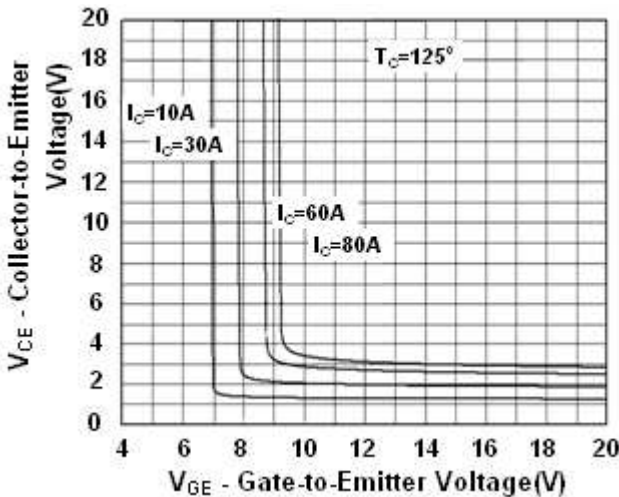

Capacitance characteristics

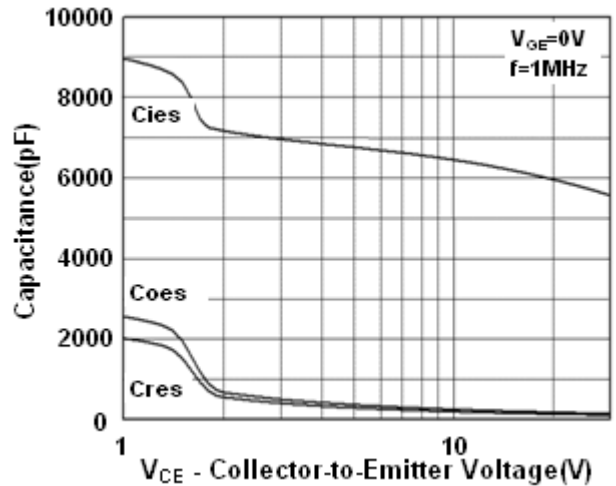

Electrical Characteristics Curve ($T_a = 25^\circ\text{C}$, unless otherwise noted)

Turn on time vs. gate resistance

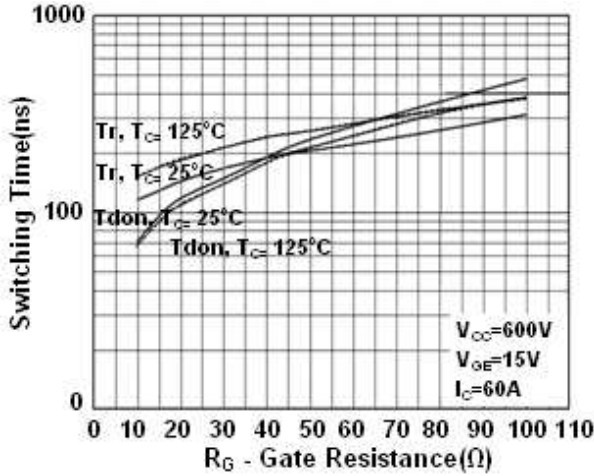

Turn off time vs. gate resistance

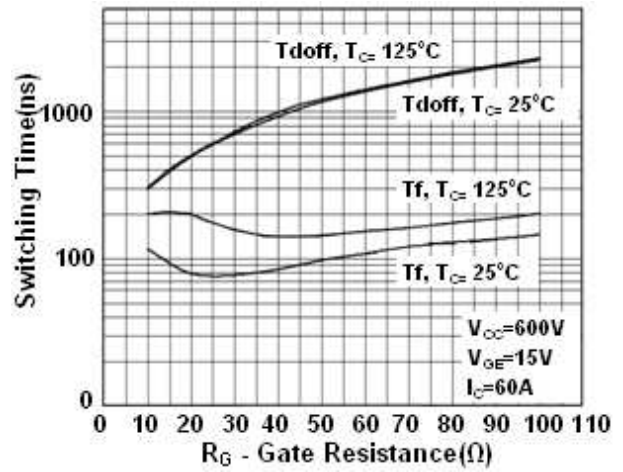

Switching loss vs. gate resistance

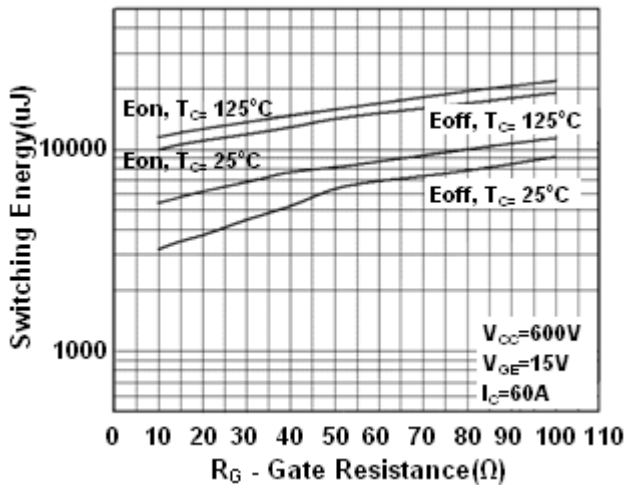

Turn on time vs. collector current

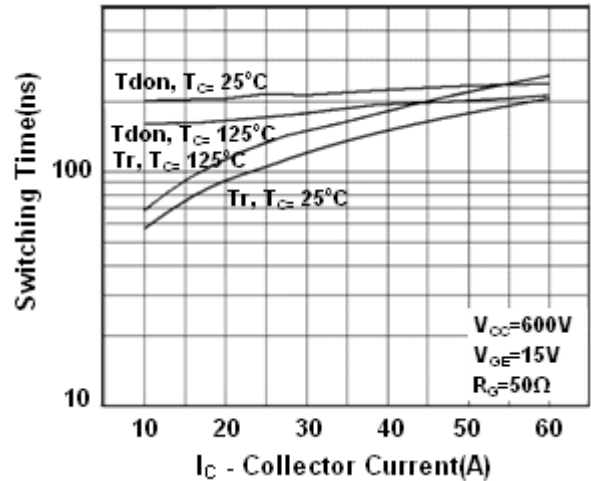

Turn off time vs. collector current

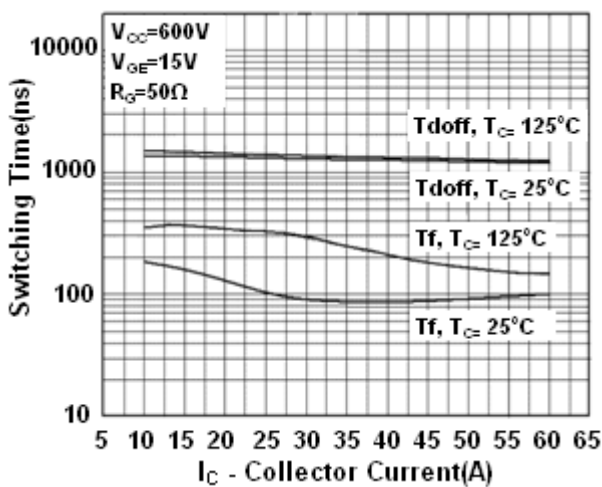

Switching loss vs. collector current

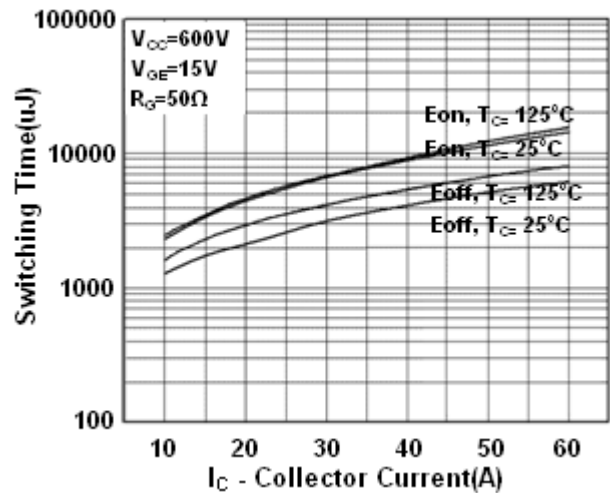

Electrical Characteristics Curve ($T_c = 25^\circ\text{C}$, unless otherwise noted)

Gate charge characteristics

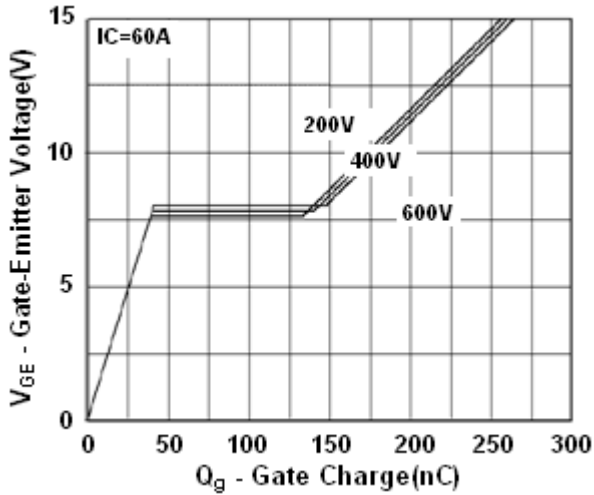

SOA Characteristics

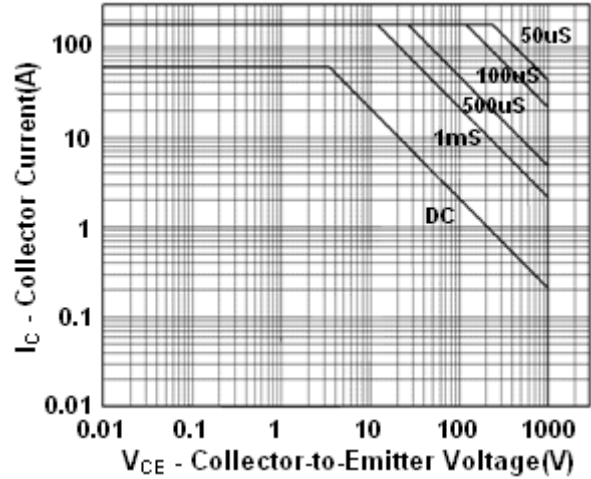

RBSOA

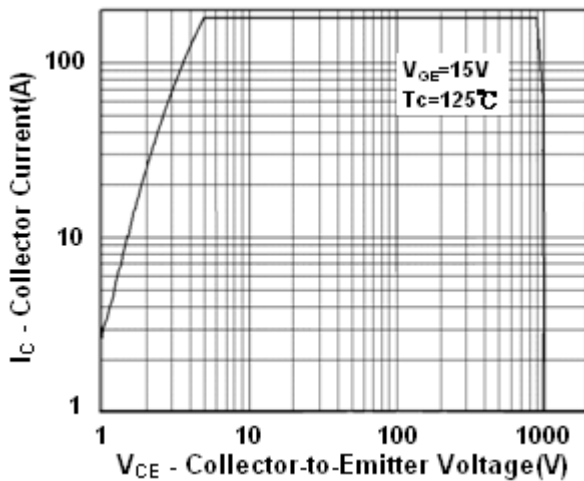

Conduction characteristics

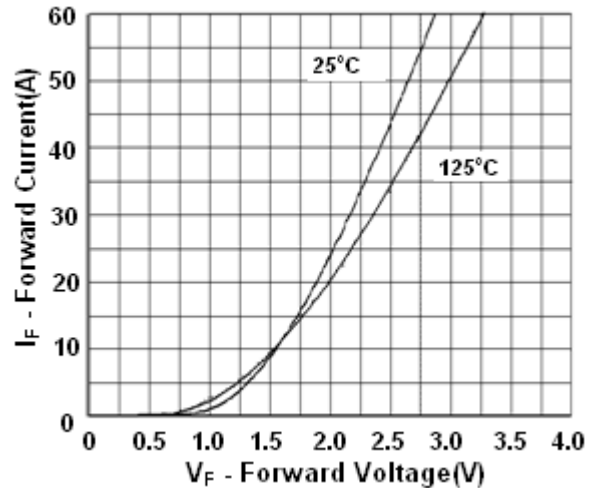

Reverse recovery current vs. forward current

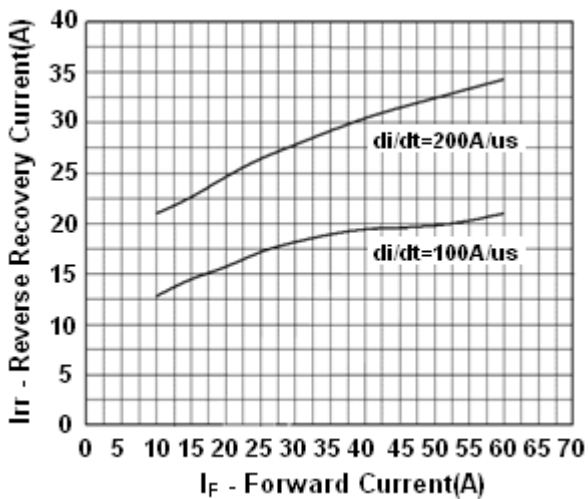

Stored recovery charge vs. forward current

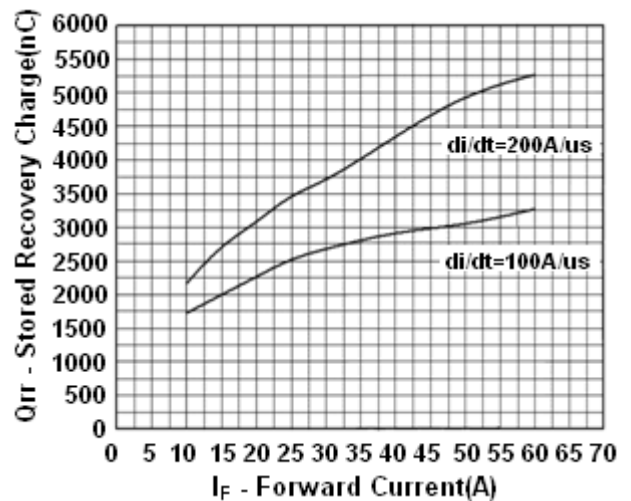

Electrical Characteristics Curve ($T_a = 25^\circ\text{C}$, unless otherwise noted)

Reverse recovery time vs. forward current

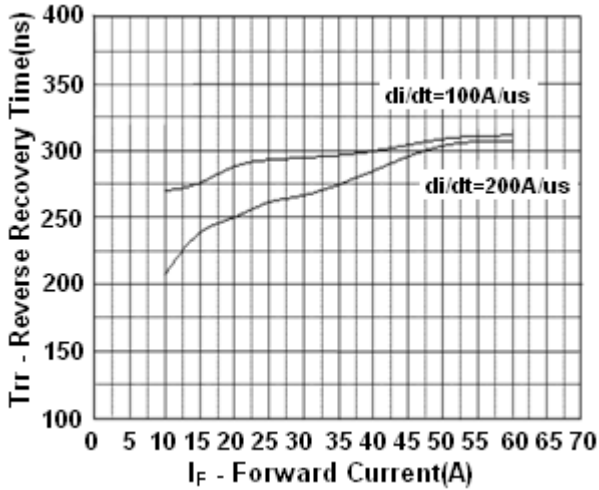

Normalized Thermal Transient Impedance, Junction-to-Ambient

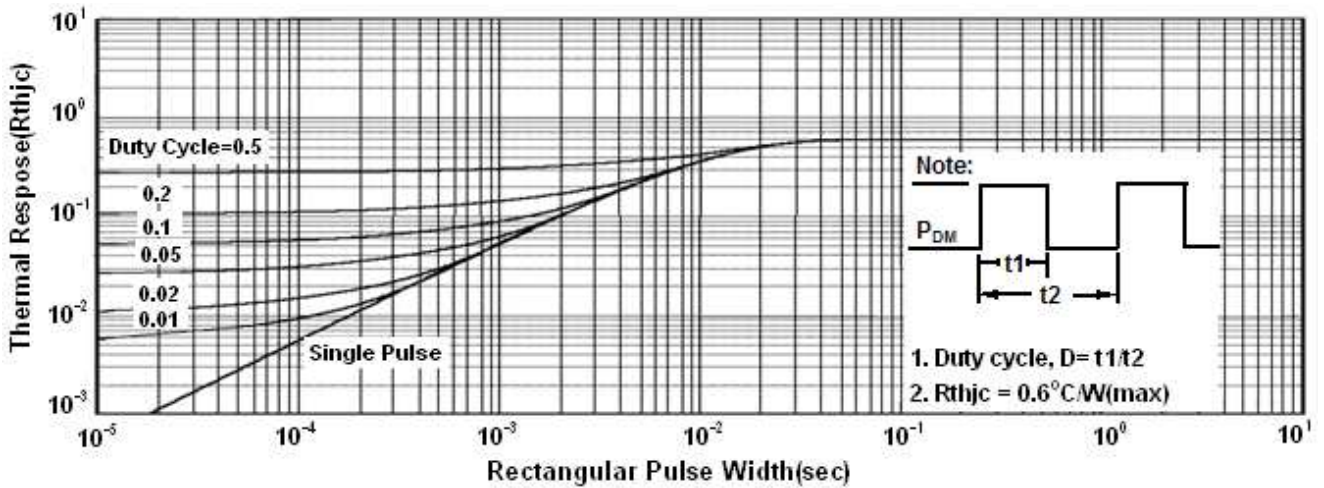

TO-264 Mechanical Drawing

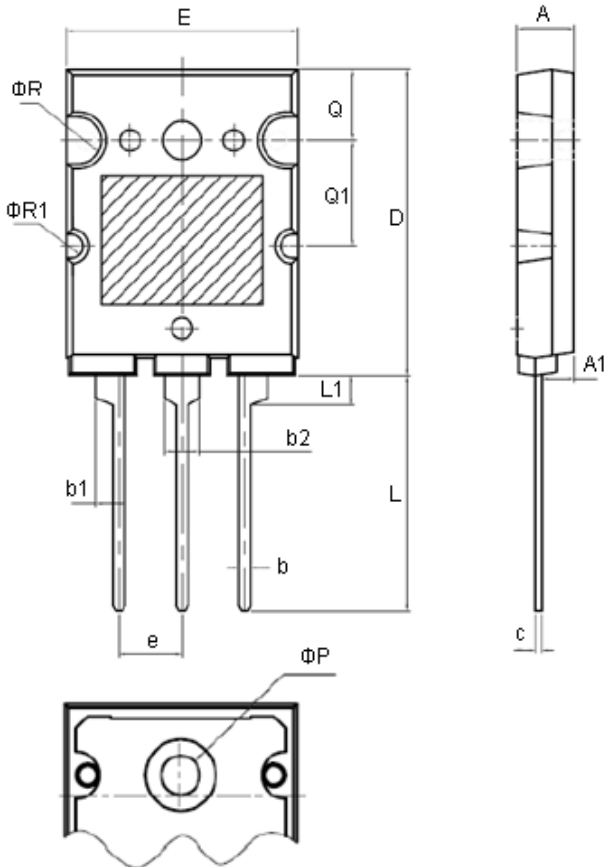

TO-264 DIMENSION						
DIM	MILLIMETERS			INCHES		
	MIN.	NOM.	MAX.	MIN.	NOM.	MAX.
A	4.8	5.0	5.2	0.189	0.197	0.205
A1	2.5	2.8	3.1	0.098	0.110	0.122
b	0.90	1.00	1.25	0.035	0.039	0.049
b1	2.3	2.5	2.7	0.091	0.098	0.106
b2	2.8	3.0	3.2	0.110	0.118	0.126
c	0.50	0.60	0.85	0.020	0.024	0.033
D	25.58	26.09	26.59	1.007	1.027	1.047
E	19.30	19.81	20.29	0.760	0.780	0.799
e	5.15	5.45	5.75	0.203	0.215	0.226
L	19.5	20.0	20.5	0.768	0.787	0.807
L1	2.4	2.5	2.6	0.094	0.098	0.102
ΦP	3.10	3.30	3.51	0.122	0.130	0.138
Q	5.8	6.0	6.2	0.228	0.236	0.244
Q1	8.8	9.0	9.2	0.346	0.354	0.362
ΦR	--	2.0	--	--	0.079	--
$\Phi R1$	--	1.0	--	--	0.039	--

Notice

Specifications of the products displayed herein are subject to change without notice. TSC or anyone on its behalf, assumes no responsibility or liability for any errors or inaccuracies.

Information contained herein is intended to provide a product description only. No license, express or implied, to any intellectual property rights is granted by this document. Except as provided in TSC's terms and conditions of sale for such products, TSC assumes no liability whatsoever, and disclaims any express or implied warranty, relating to sale and/or use of TSC products including liability or warranties relating to fitness for a particular purpose, merchantability, or infringement of any patent, copyright, or other intellectual property right.

The products shown herein are not designed for use in medical, life-saving, or life-sustaining applications. Customers using or selling these products for use in such applications do so at their own risk and agree to fully indemnify TSC for any damages resulting from such improper use or sale.