

FAST RECOVERY RECTIFIER DIODES

- HIGH REVERSE VOLTAGE CAPABILITY
- VERY LOW REVERSE RECOVERY TIME
- VERY LOW SWITCHING LOSSES
- LOW NOISE TURN-OFF SWITCHING

SUITABLE APPLICATIONS

- FREE WHEELING DIODE IN CONVERTERS AND MOTOR CONTROL CIRCUITS
- RECTIFIER IN S.M.P.S.

Cathode connected to case



DO 5
(Metal)

ABSOLUTE RATINGS (limiting values)

Symbol	Parameter		Value	Unit
I_{FRM}	Repetitive Peak Forward Current	$t_p \leq 10\mu s$	375	A
$I_{F(RMS)}$	RMS Forward Current		70	A
$I_{F(AV)}$	Average Forward Current	$T_{case} = 75^\circ C$ $\delta = 0.5$	30	A
I_{FSM}	Surge non Repetitive Forward Current	$t_p = 10ms$ Sinusoidal	200	A
P	Power Dissipation	$T_{case} = 75^\circ C$	62	W
T_{stg} T_j	Storage and Junction Temperature Range		- 40 to + 150	$^\circ C$

Symbol	Parameter	BYT 30-		Unit
		600	800	
V_{RRM}	Repetitive Peak Reverse Voltage	600	800	V
V_{RSM}	Non Repetitive Peak Reverse Voltage	640	850	V

THERMAL RESISTANCE

Symbol	Parameter	Value	Unit
$R_{th(j-c)}$	Junction-case	1.2	$^\circ C/W$

ELECTRICAL CHARACTERISTICS

STATIC CHARACTERISTICS

Symbol	Test Conditions		Min.	Typ.	Max.	Unit
I_R	$T_j = 25^\circ\text{C}$	$V_R = V_{RRM}$			100	μA
	$T_j = 100^\circ\text{C}$				5	mA
V_F	$T_j = 25^\circ\text{C}$	$I_F = 30\text{A}$			1.9	V
	$T_j = 100^\circ\text{C}$				1.8	

RECOVERY CHARACTERISTICS

Symbol	Test Conditions		Min.	Typ.	Max.	Unit
t_{rr}	$T_j = 25^\circ\text{C}$	$I_F = 1\text{A}$ $di_F/dt = -15\text{A}/\mu\text{s}$ $V_R = 30\text{V}$			130	ns
		$I_F = 0.5\text{A}$ $I_R = 1\text{A}$ $t_{rr} = 0.25\text{A}$			55	

TURN -OFF SWITCHING CHARACTERISTICS (Without Series Inductance)

Symbol	Test Conditions		Min.	Typ.	Max.	Unit
t_{IRM}	$di_F/dt = -120\text{A}/\mu\text{s}$	$V_{CC} = 200\text{V}$ $I_F = 30\text{A}$ $L_p \leq 0.05\mu\text{H}$ $T_j = 100^\circ\text{C}$ See figure 11			160	ns
	$di_F/dt = -240\text{A}/\mu\text{s}$			100		
I_{RM}	$di_F/dt = -120\text{A}/\mu\text{s}$				15	A
	$di_F/dt = -240\text{A}/\mu\text{s}$				19	

TURN -OFF OVERVOLTAGE COEFFICIENT (With Series Inductance)

Symbol	Test Conditions		Min.	Typ.	Max.	Unit
$C = \frac{V_{RP}}{V_{CC}}$	$T_j = 100^\circ\text{C}$ $di_F/dt = -30\text{A}/\mu\text{s}$	$V_{CC} = 150\text{V}$ $I_F = I_{F(AV)}$ $L_p = 4\mu\text{H}$ See figure 12			4	

To evaluate the conduction losses use the following equation :

$$V_F = 1.47 + 0.010 I_F \quad P = 1.47 \times I_{F(AV)} + 0.010 I_F^2_{(RMS)}$$

PACKAGE MECHANICAL DATA : DO 5 Metal

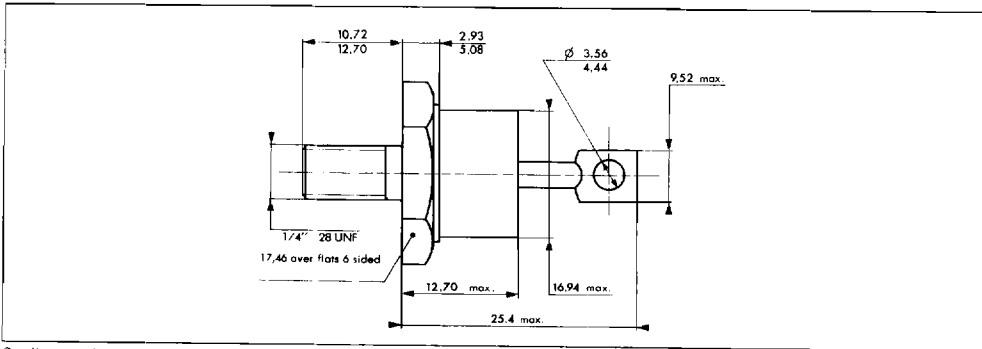

Cooling method : by conduction (method C)

Marking : type number

Weight : 18.84g

Recommended torque value : 250cm. N

Maximum torque value : 310cm. N

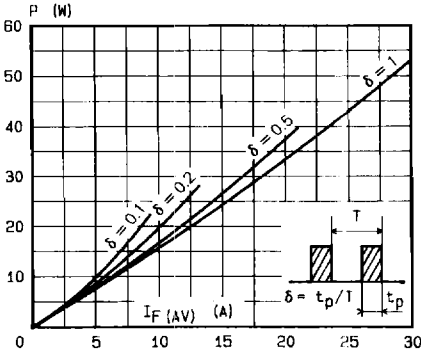

FIGURE 1 : Low frequency power losses versus average current.

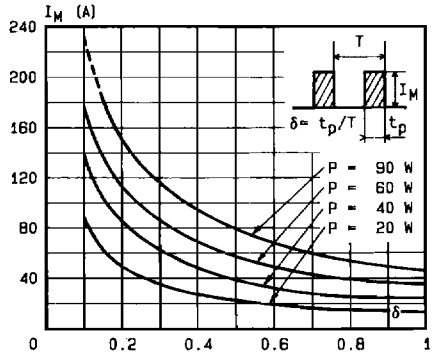

FIGURE 2 : Peak current versus form factor.

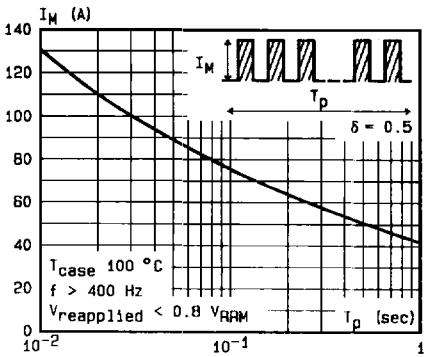

FIGURE 3 : Non repetitive peak surge current versus overload duration.

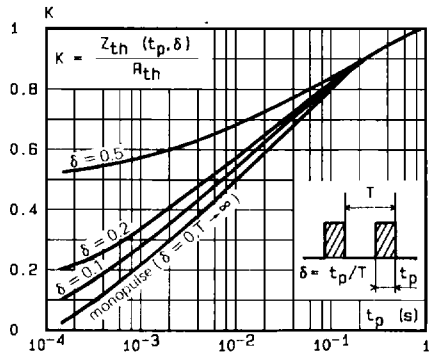

FIGURE 4 : Thermal impedance versus pulse width.

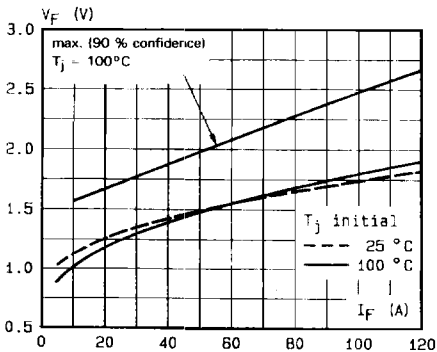

FIGURE 5 : Voltage drop versus forward current.

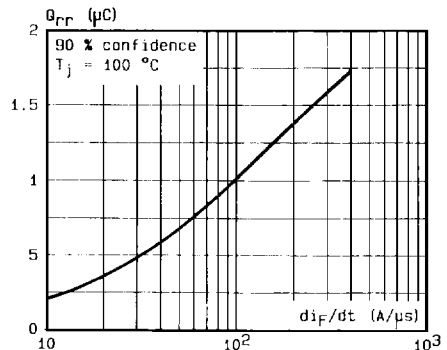

FIGURE 8 : Recovery charge versus di_F/dt .

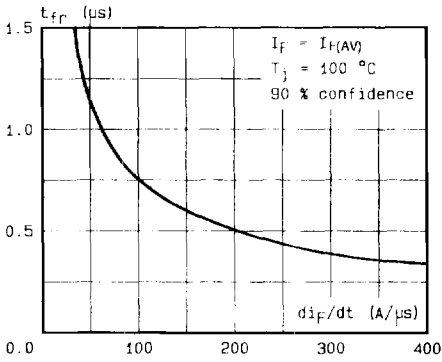

FIGURE 7 : Recovery time versus di_F/dt .

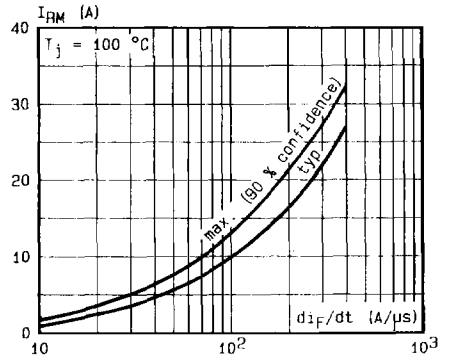

FIGURE 8 : Peak reverse current versus di_F/dt .

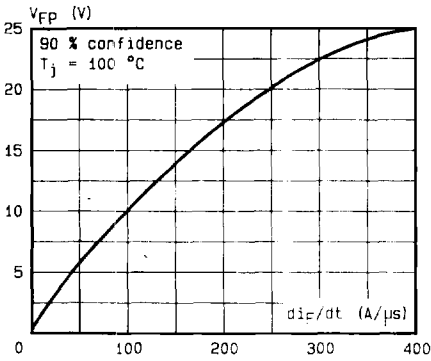

FIGURE 9 : Peak forward voltage versus di_F/dt .

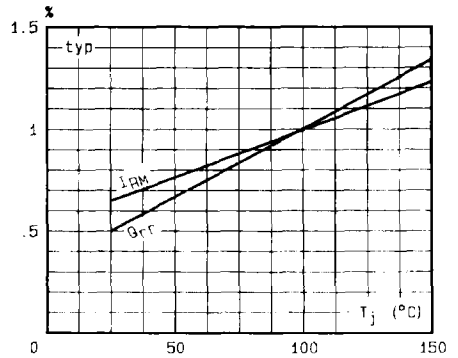

FIGURE 10 : Dynamic parameters versus junction temperature.

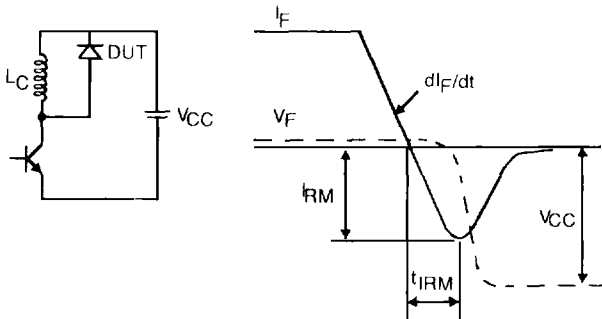

Figure 11 : Turn-off switching characteristics (without series inductance)

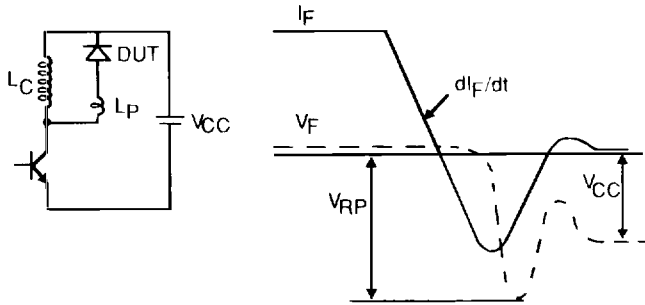

Figure 12 : Turn-off switching characteristics (with series inductance)