

FAST RECOVERY RECTIFIER DIODES

- VERY LOW REVERSE RECOVERY TIME
- VERY LOW SWITCHING LOSSES
- LOW NOISE TURN-OFF SWITCHING

SUITABLE APPLICATIONS

- FREE WHEELING DIODE IN CONVERTERS AND MOTOR CONTROL CIRCUITS
- RECTIFIER IN S.M.P.S.

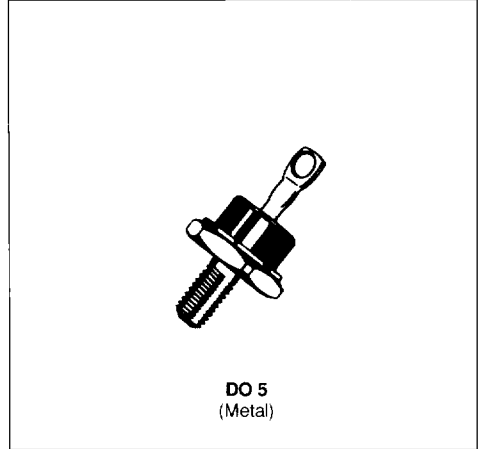

ABSOLUTE RATINGS (limiting values)

Symbol	Parameter		Value	Unit
I_{FRM}	Repetitive Peak Forward Current	$t_p \leq 10\mu s$	500	A
$I_{F(RMS)}$	RMS Forward Current		50	A
$I_{F(AV)}$	Average Forward Current	$T_{case} = 90^\circ C$ $\delta = 0.5$	30	A
I_{FSM}	Surge non Repetitive Forward Current	$t_p = 10ms$ sinusoidal	500	A
P	Power Dissipation	$T_{case} = 90^\circ C$	50	W
T_{stg} T_j	Storage and Junction Temperature Range		- 40 to + 150	$^\circ C$

Symbol	Parameter	BYT 30-			Unit
		200	300	400	
V_{RRM}	Repetitive Peak Reverse Voltage	200	300	400	V
V_{RSM}	Non Repetitive Peak Reverse Voltage	220	330	440	V

THERMAL RESISTANCE

Symbol	Parameter	Value	Unit
$R_{th(j-c)}$	Junction-case	1.2	$^\circ C/W$

ELECTRICAL CHARACTERISTICS

STATIC CHARACTERISTICS

Symbol	Test Conditions	Min.	Typ.	Max.	Unit
I _R	T _J = 25°C	V _R = V _{RRM}		35	μA
	T _J = 100°C				mA
V _F	T _J = 25°C	I _F = 30A		1.5	V
	T _J = 100°C				1.4

RECOVERY CHARACTERISTICS

Symbol	Test Conditions	Min.	Typ.	Max.	Unit
t _{rr}	T _J = 25°C	I _F = 1A di _F /dt = - 15A/μs V _R = 30V		100	ns
		I _F = 0.5A I _R = 1A t _{rr} = 0.25A		50	

TURN -OFF SWITCHING CHARACTERISTICS (Without Series Inductance)

Symbol	Test Conditions	Min.	Typ.	Max.	Unit
t _{IRM}	di _F /dt = - 120A/μs	V _{CC} = 200V I _F = 30A L _p ≤ 0.05μH T _J = 100°C See Figure 11		75	ns
	di _F /dt = - 240A/μs				
I _{IRM}	di _F /dt = - 120A/μs			9	A
	di _F /dt = - 240A/μs				

TURN -OFF OVERVOLTAGE COEFFICIENT (With Series Inductance)

Symbol	Test Conditions	Min.	Typ.	Max.	Unit
$C = \frac{V_{RP}}{V_{CC}}$	T _J = 100°C V _{CC} = 60V I _F = I _{F(AV)} di _F /dt = - 30A/μs L _p = 1μH See Figure 12		3.3		

To evaluate the conduction losses use the following equations :

$$V_F = 1.1 + 0.0095 I_F \quad P = 1.1 \times I_{F(AV)} + 0.0095 I_F^2 (RMS)$$

PACKAGE MECHANICAL DATA : DO 5 Metal

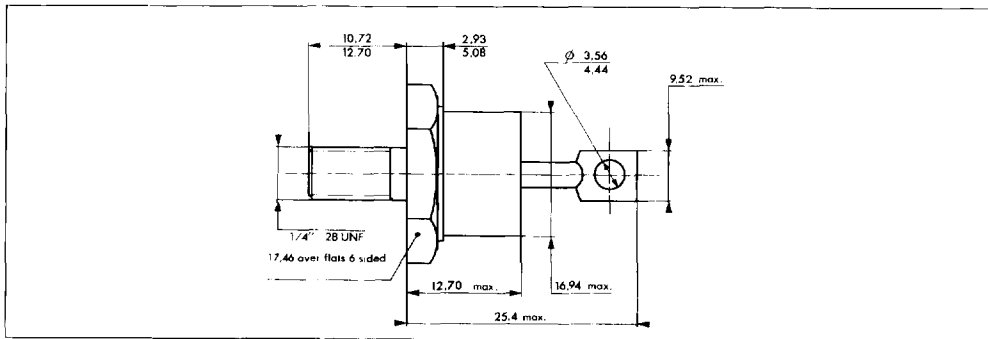

Cooling method : by conduction (method C)

Marking : Cathode connected to case : type number

Anode connected to case : type number + suffix R (consult us for these reverse version data sheets)

Weight : 18.84g

Recommended torque value : 250cm. N

Maximum torque value : 310cm. N

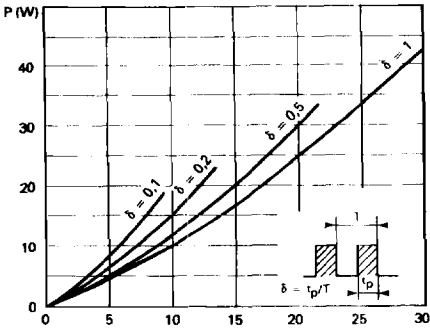

FIGURE 1: Low frequency power losses versus average current (A)

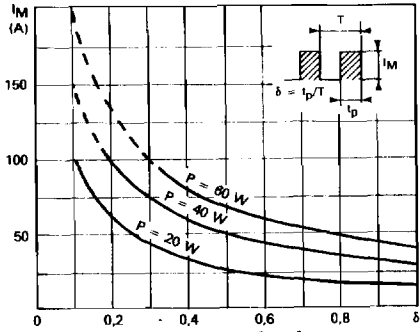

FIGURE 2: Peak current versus form factor.

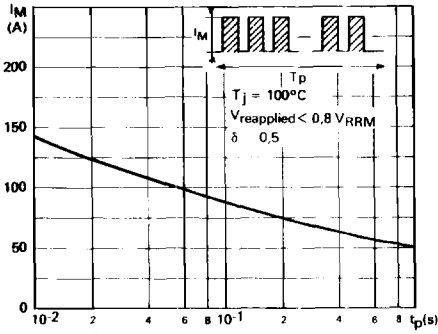

FIGURE 3: Non repetitive peak surge current versus overload duration.

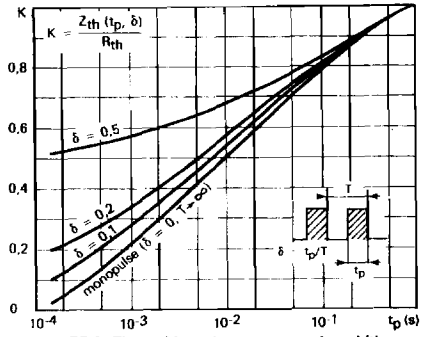

FIGURE 4: Thermal impedance versus pulse width.

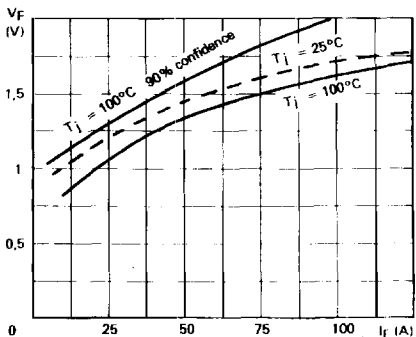

FIGURE 5: Voltage drop versus forward current.

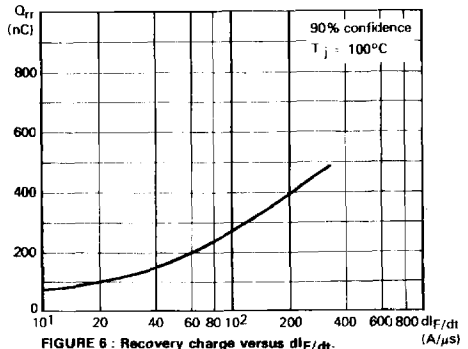

FIGURE 6: Recovery charge versus dI_f/dt .

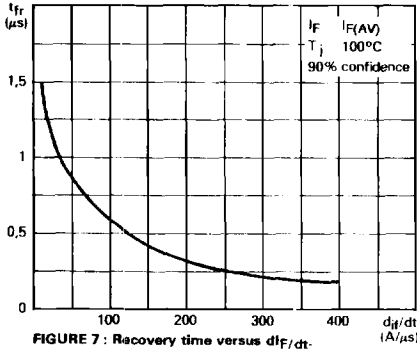

FIGURE 7 : Recovery time versus dI_F/dt .

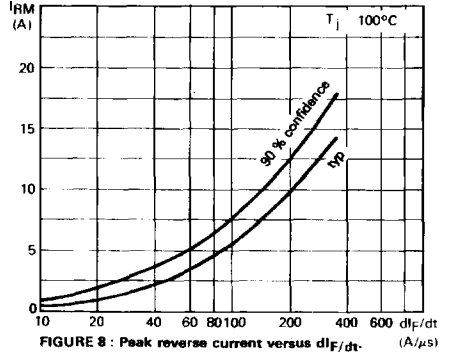

FIGURE 8 : Peak reverse current versus dI_F/dt .

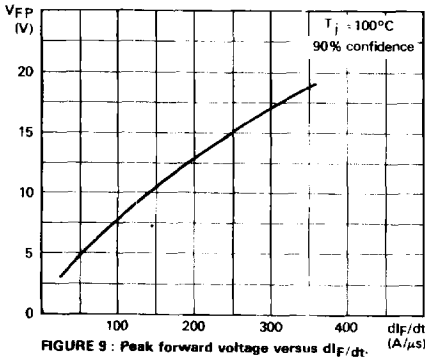

FIGURE 9 : Peak forward voltage versus dI_F/dt .

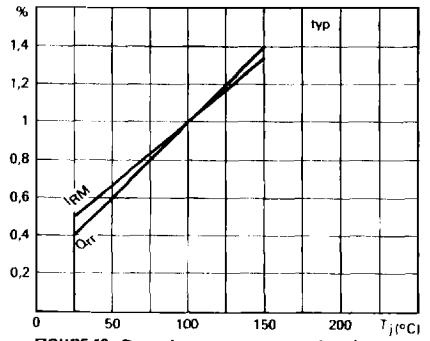

FIGURE 10 : Dynamic parameters versus junction temperature.

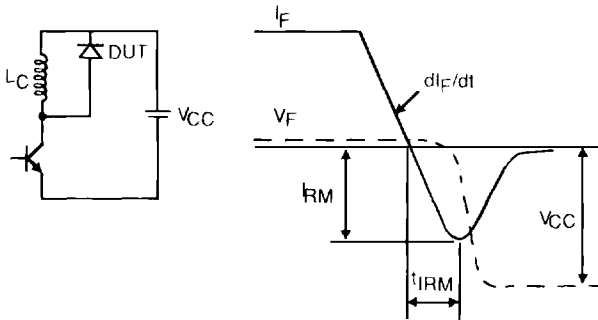

Figure 11 : Turn-off switching characteristics (without series inductance).

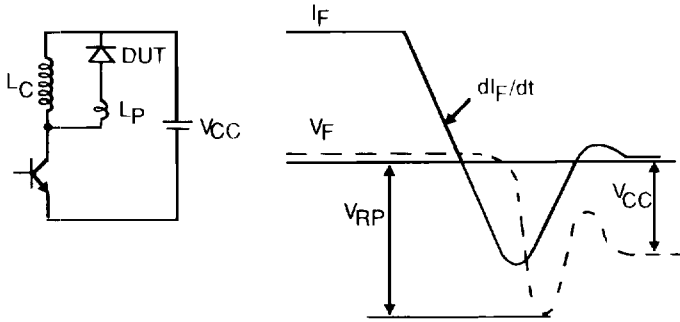

Figure 12 : Turn-off switching characteristics (with series inductance).