

BSS84 / BSS110 P-Channel Enhancement Mode Field Effect Transistor

General Description

These P-Channel enhancement mode power field effect transistors are produced using Fairchild's proprietary, high cell density, DMOS technology. This very high density process is designed to minimize on-state resistance, provide rugged and reliable performance and fast switching. They can be used, with a minimum of effort, in most applications requiring up to 0.17A DC and can deliver pulsed currents up to 0.68A. This product is particularly suited to low voltage applications requiring a low current high side switch.

Features

- BSS84: -0.13A, -50V. $R_{DS(ON)} = 10\Omega @ V_{GS} = -5V$.
BSS110: -0.17A, -50V. $R_{DS(ON)} = 10\Omega @ V_{GS} = -10V$
- Voltage controlled p-channel small signal switch.
- High density cell design for low $R_{DS(ON)}$.
- High saturation current.

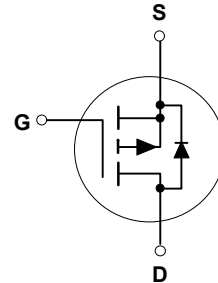
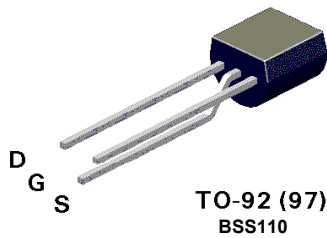
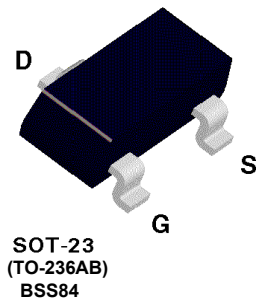

Absolute Maximum Ratings

$T_A = 25^\circ\text{C}$ unless otherwise noted

Symbol	Parameter	BSS84	BSS110	Units
V_{DSS}	Drain-Source Voltage		-50	V
V_{DGR}	Drain-Gate Voltage ($R_{GS} \leq 20\text{ K}\Omega$)		-50	V
V_{GSS}	Gate-Source Voltage - Continuous		± 20	V
I_D	Drain Current - Continuous @ $T_A = 30/35^\circ\text{C}$	-0.13	-0.17	A
	- Pulsed @ $T_A = 25^\circ\text{C}$	-0.52	-0.68	
P_D	Maximum Power Dissipation $T_A = 25^\circ\text{C}$	0.36	0.63	W
T_J, T_{STG}	Operating and Storage Temperature Range		-55 to 150	$^\circ\text{C}$
T_L	Maximum lead temperature for soldering purposes, 1/16" from case for 10 seconds		300	$^\circ\text{C}$

THERMAL CHARACTERISTICS

Symbol	Parameter	BSS84	BSS110	Units
$R_{\theta JA}$	Thermal Resistance, Junction-to-Ambient	350	200	$^\circ\text{C}/\text{W}$

ELECTRICAL CHARACTERISTICS ($T_A = 25^\circ\text{C}$ unless otherwise noted)

Symbol	Parameter	Conditions	Type	Min	Typ	Max	Units
OFF CHARACTERISTICS							
BV_{DSS}	Drain-Source Breakdown Voltage	$V_{GS} = 0\text{ V}, I_D = -250\ \mu\text{A}$	All	-50			V
I_{DSS}	Zero Gate Voltage Drain Current	$V_{DS} = -50\text{ V},$ $V_{GS} = 0\text{ V}$ $T_J = 125^\circ\text{C}$	All			-15	μA
						-60	μA
						-0.1	μA
I_{GSSR}	Gate - Body Leakage, Reverse	$V_{GS} = -20\text{ V}, V_{DS} = 0\text{ V}$	All			-10	nA
ON CHARACTERISTICS (Note 1)							
$V_{GS(th)}$	Gate Threshold Voltage	$V_{DS} = V_{GS}, I_D = -1\text{ mA}$	All	-0.8	-1.75	-2	V
$R_{DS(ON)}$	Static Drain-Source On-Resistance	$V_{GS} = -5\text{ V}, I_D = -0.10\text{ A}$ $V_{GS} = -10\text{ V}, I_D = -0.17\text{ A}$	BSS84		3.2	10	Ω
			BSS110		2.2	10	
g_{FS}	Forward Transconductance	$V_{DS} = -25\text{ V}, I_D = -0.10\text{ A}$ $V_{DS} = -10\text{ V}, I_D = -0.17\text{ A}$	BSS84	0.05	0.27		S
			BSS110	0.05	0.29		
DYNAMIC CHARACTERISTICS							
C_{iss}	Input Capacitance	$V_{DS} = -25\text{ V}, V_{GS} = 0\text{ V},$ $f = 1.0\text{ MHz}$	BSS84		37	45	pF
			BSS110		37	40	
C_{oss}	Output Capacitance		All		16	25	pF
C_{rss}	Reverse Transfer Capacitance		All		5	12	pF
SWITCHING CHARACTERISTICS (Note 1)							
$t_{D(on)}$	Turn - On Delay Time	$V_{DD} = -30\text{ V}, I_D = -0.27\text{ A},$ $V_{GS} = -10\text{ V}, R_{GEN} = 50\ \Omega$	All			12	nS
t_r	Turn - On Rise Time		All			50	nS
$t_{D(off)}$	Turn - Off Delay Time		All			10	nS
t_f	Turn - Off Fall Time		All			25	nS
DRAIN-SOURCE DIODE CHARACTERISTICS							
I_S	Continuous Source Diode Current		BSS84			-0.13	A
			BSS110			-0.17	
I_{SM}	Maximum Pulsed Source Diode Current (Note 1)		BSS84			-0.52	A
			BSS110			-0.68	
V_{SD}	Drain-Source Diode Forward Voltage	$V_{GS} = 0\text{ V}, I_S = -0.26\text{ A}$ (Note 1)	BSS84		-0.95	-1.2	V
		$V_{GS} = 0\text{ V}, I_S = -0.34\text{ A}$ (Note 1)	BSS110		-1	-1.2	

Note:

 1. Pulse Test: Pulse Width $\leq 300\ \mu\text{s}$, Duty Cycle $\leq 2.0\%$.

Typical Electrical Characteristics

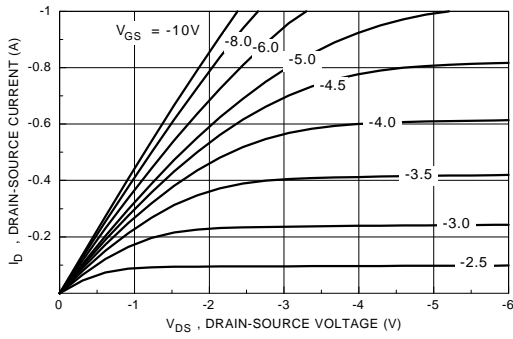

Figure 1. On-Region Characteristics

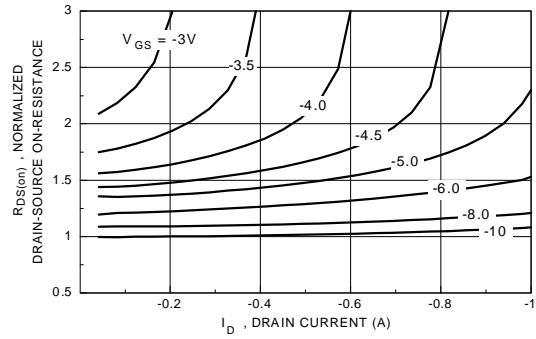

Figure 2. On-Resistance Variation with Drain Current and Gate Voltage

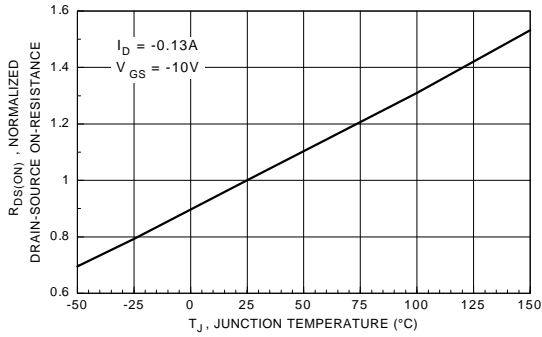

Figure 3. On-Resistance Variation with Temperature

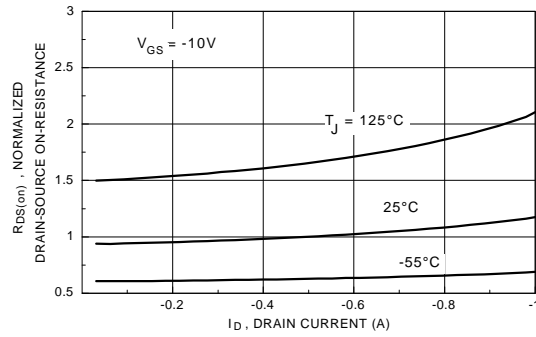

Figure 4. On-Resistance Variation with Drain Current and Temperature

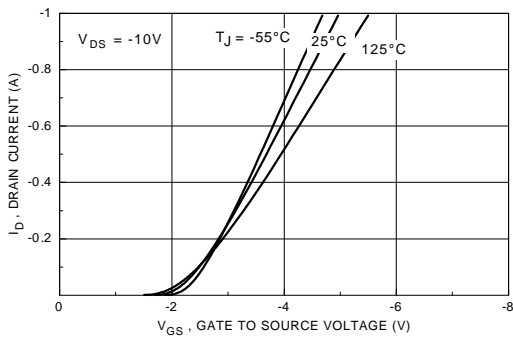

Figure 5. Transfer Characteristics

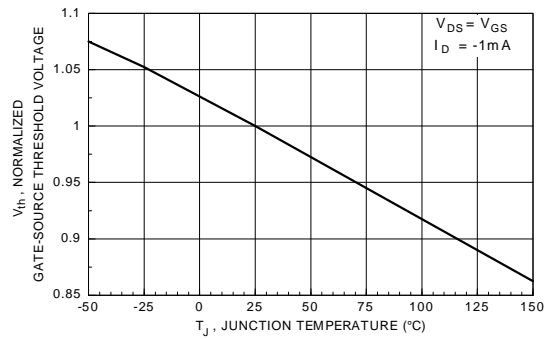

Figure 6. Gate Threshold Variation with Temperature

Typical Electrical Characteristics (continued)

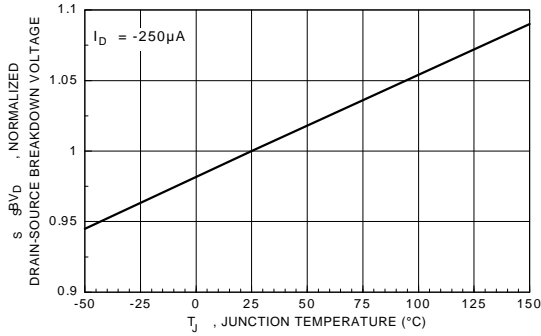

Figure 7. Breakdown Voltage Variation with Temperature

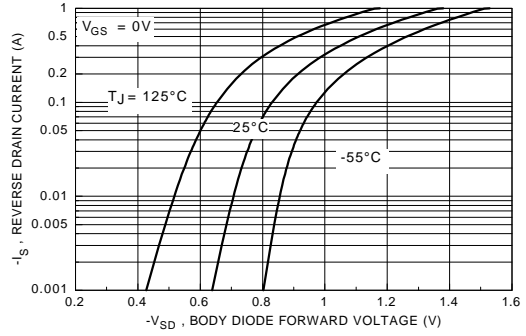

Figure 8. Body Diode Forward Voltage Variation with Source Current and Temperature

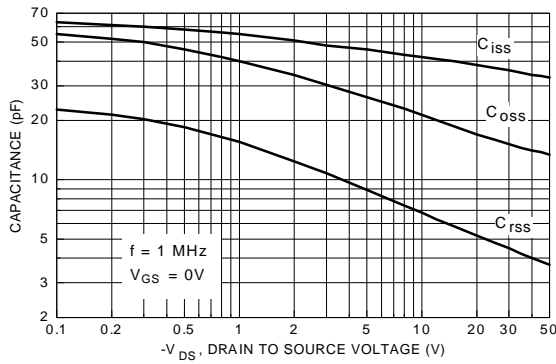

Figure 9. Capacitance Characteristics

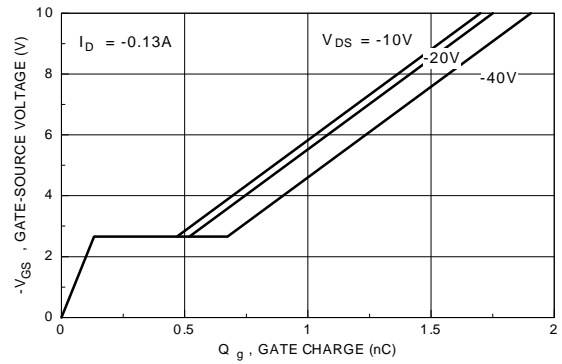

Figure 10. Gate Charge Characteristics

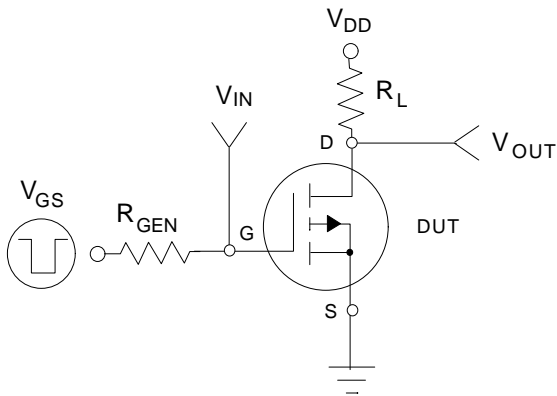

Figure 11. Switching Test Circuit

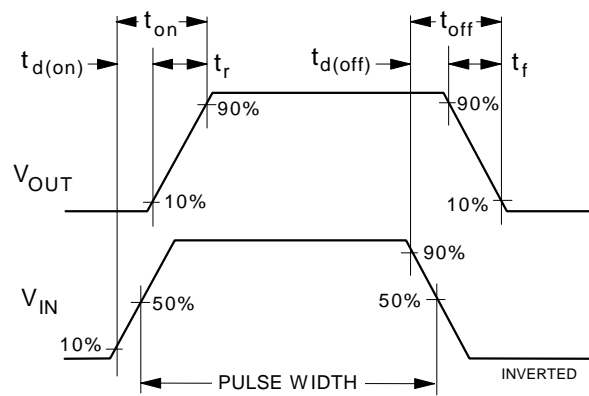

Figure 12. Switching Waveforms

Typical Electrical Characteristics (continued)

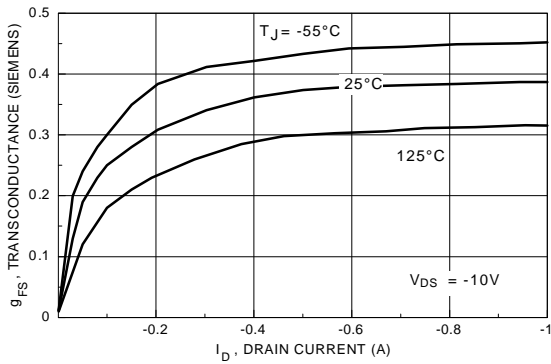

Figure 13. Transconductance Variation with Drain Current and Temperature

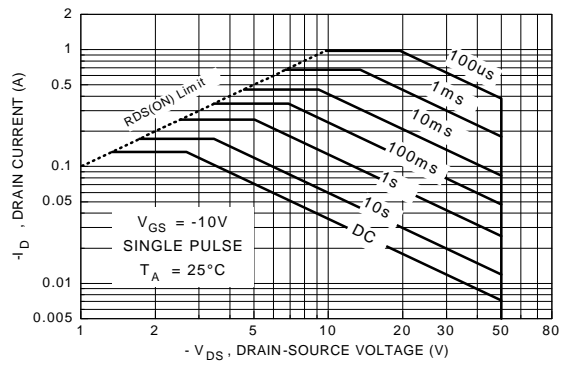

Figure 14. Maximum Safe Operating Area

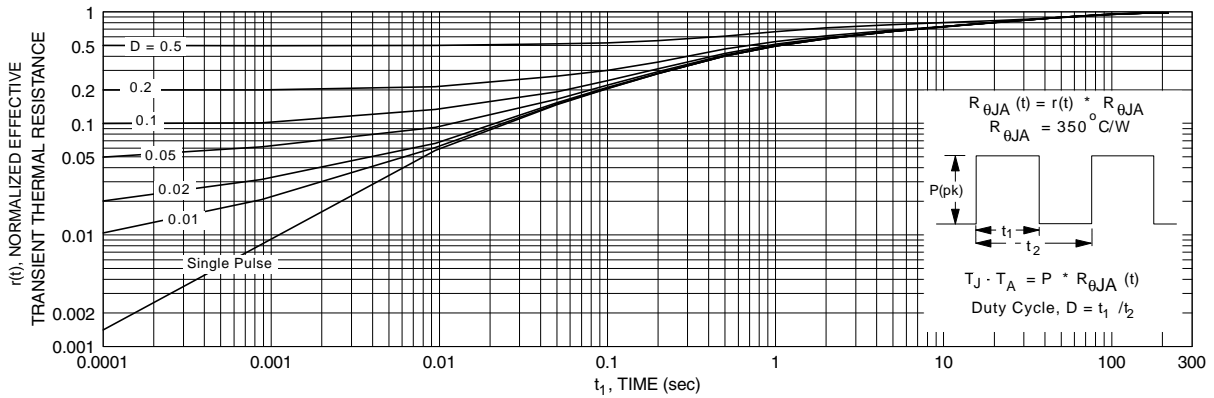

Figure 15. Transient Thermal Response Curve

Note : Characterization performed using a circuit board with 175°C/W typical case-to-ambient thermal resistance.

TO-92 Package Dimensions



TO-92; TO-18 Reverse Lead Form (J35Z Option) (FS PKG Code 92, 94, 96)

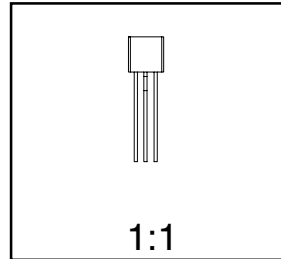
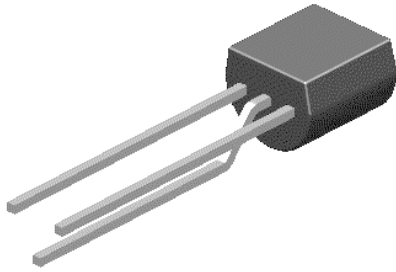

Scale 1:1 on letter size paper

Dimensions shown below are in:
inches [millimeters]

Part Weight per unit (gram): 0.22

TO-92(92,94,96,97*,98*);
TO-18 REVERSE LEADFORM
(J35Z)

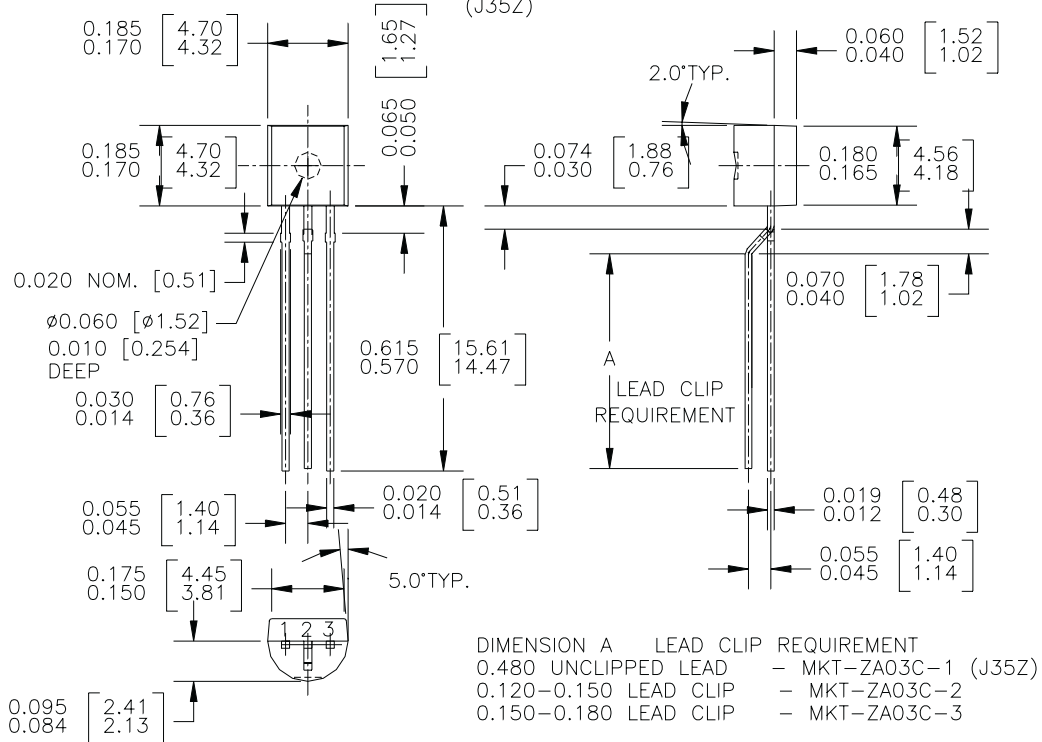

Note: All package 97 or 98 transistors are leadformed to this configuration prior to bulk shipment. Order L34Z option if in-line leads are preferred on package 97 or 98.

* Standard Option on 97 & 98 package code

TRADEMARKS

The following are registered and unregistered trademarks Fairchild Semiconductor owns or is authorized to use and is not intended to be an exhaustive list of all such trademarks.

ACE _x TM	FAST [®]	OPTOPLANAR TM	STAR*POWER TM
Bottomless TM	FAST _r TM	PACMAN TM	Stealth TM
CoolFET TM	FRFET TM	POP TM	SuperSOT TM -3
CROSSVOLT TM	GlobalOptoisolator TM	Power247 TM	SuperSOT TM -6
DenseTrench TM	GTO TM	PowerTrench [®]	SuperSOT TM -8
DOME TM	HiSeC TM	QFET TM	SyncFET TM
EcoSPARK TM	ISOPLANAR TM	QS TM	TinyLogic TM
E ² CMOS TM	LittleFET TM	QT Optoelectronics TM	TruTranslation TM
EnSigna TM	MicroFET TM	Quiet Series TM	UHC TM
FACT TM	MICROWIRE TM	SILENT SWITCHER [®]	UltraFET [®]
FACT Quiet Series TM	OPTOLOGIC TM	SMART START TM	VCX TM

STAR*POWER is used under license

DISCLAIMER

FAIRCHILD SEMICONDUCTOR RESERVES THE RIGHT TO MAKE CHANGES WITHOUT FURTHER NOTICE TO ANY PRODUCTS HEREIN TO IMPROVE RELIABILITY, FUNCTION OR DESIGN. FAIRCHILD DOES NOT ASSUME ANY LIABILITY ARISING OUT OF THE APPLICATION OR USE OF ANY PRODUCT OR CIRCUIT DESCRIBED HEREIN; NEITHER DOES IT CONVEY ANY LICENSE UNDER ITS PATENT RIGHTS, NOR THE RIGHTS OF OTHERS.

LIFE SUPPORT POLICY

FAIRCHILD'S PRODUCTS ARE NOT AUTHORIZED FOR USE AS CRITICAL COMPONENTS IN LIFE SUPPORT DEVICES OR SYSTEMS WITHOUT THE EXPRESS WRITTEN APPROVAL OF FAIRCHILD SEMICONDUCTOR CORPORATION. As used herein:

1. Life support devices or systems are devices or systems which, (a) are intended for surgical implant into the body, or (b) support or sustain life, or (c) whose failure to perform when properly used in accordance with instructions for use provided in the labeling, can be reasonably expected to result in significant injury to the user.
2. A critical component is any component of a life support device or system whose failure to perform can be reasonably expected to cause the failure of the life support device or system, or to affect its safety or effectiveness.

PRODUCT STATUS DEFINITIONS

Definition of Terms

Datasheet Identification	Product Status	Definition
Advance Information	Formative or In Design	This datasheet contains the design specifications for product development. Specifications may change in any manner without notice.
Preliminary	First Production	This datasheet contains preliminary data, and supplementary data will be published at a later date. Fairchild Semiconductor reserves the right to make changes at any time without notice in order to improve design.
No Identification Needed	Full Production	This datasheet contains final specifications. Fairchild Semiconductor reserves the right to make changes at any time without notice in order to improve design.
Obsolete	Not In Production	This datasheet contains specifications on a product that has been discontinued by Fairchild semiconductor. The datasheet is printed for reference information only.