

ACNV2601

High Insulation Voltage 10 MBd Digital Optocoupler



Data Sheet

Description

The ACNV2601 is an optically coupled gate that combines an AlGaAs light-emitting diode and an integrated photo detector housed in a widebody package. The distance-through-insulation (DTI) between the emitting diode and photo-detector is at 2 mm. The output of the detector IC is an open collector Schottky clamped transistor. The internal shield provides a guaranteed common mode transient immunity specification of 20 kV/ μ s at $V_{CM} = 1500$ V

With creepage and clearance of greater than 13 mm, ACNV2601 is designed to provide high isolation voltage (7500 V_{rms}). It can withstand a continuous high working voltage of 2262 V_{peak} and a surge voltage of 12,000 V_{peak} , meeting IEC60747-5-5, UL and CSA standard for reinforced insulation. ACNV2601 provides the high insulation voltage protection at a high data rate of 10 MBd.

Functional Diagram

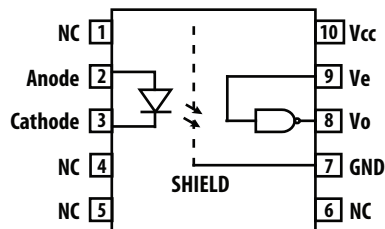

Truth Table
(Positive Logic)

LED	ENABLE	OUTPUT
On	H	L
Off	H	H
On	L	H
Off	L	H
On	NC	L
Off	NC	H

A 0.1 μ F bypass capacitor must be connected between pins V_{CC} and GND.

Features

- High Voltage Insulation with minimum 13 mm creepage and clearance
- 20 kV/ μ s Minimum Common Mode Rejection (CMR) at $V_{CM} = 1500$ V
- High Speed: 10 MBd Typical
- TTL Compatible
- Open Collector Output
- Guaranteed AC and DC performance over wide temperature: -40 °C to +105 °C
- Available in 10-pin widebody packages
- Safety Approval to be submitted for approval
 - Approval at 7500 V_{rms} for 1 minute per UL1577
 - CSA
 - IEC/EN/DIN EN 60747-5-5 with $V_{iorm} = 2262V_{peak}$

Applications

- High voltage insulation
- Instrument input/output isolation
- Line receivers
- Ground loop elimination
- Isolation of high speed logic systems
- Microprocessor system interfaces

CAUTION: It is advised that normal static precautions be taken in handling and assembly of this component to prevent damage and/or degradation which may be induced by ESD.

Ordering Information

ACNV2601 is UL recognized with 7500 Vrms for 1 minute per UL1577.

Part number	Option	Package	Surface Mount	Gull Wing	Tape & Reel	UL 7500 V _{rms} /1 Minute rating	IEC/EN/DIN EN 60747-5-5	Quantity
	RoHS Compliant							
ACNV2601	-000E	500 mil DIP-10				X	X	35 per tube
	-300E		X	X		X	X	35 per tube
	-500E		X	X	X	X	X	500 per reel

To order, choose a part number from the Part number column and combine with the desired option from the Option column to form an order entry.

Example 1:

ACNV2601-500E to order product of 500mil DIP-10 Widebody with Gull Wing Surface Mount package in Tape and Reel packaging with both UL 7500 V_{rms}/1min and IEC/EN/DIN EN 60747-5-5 Safety Approval in RoHS compliant.

Option datasheets are available. Contact your Avago sales representative or authorized distributor for information.

Schematic

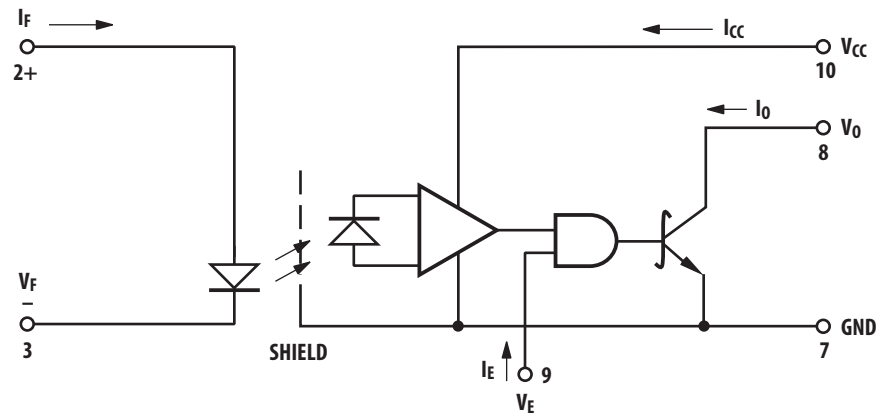

Use of a 0.1 μ F bypass capacitor connected between pins of 7 and 10 is recommended (see note 5)

10-Pin Widebody (500mils) DIP Package

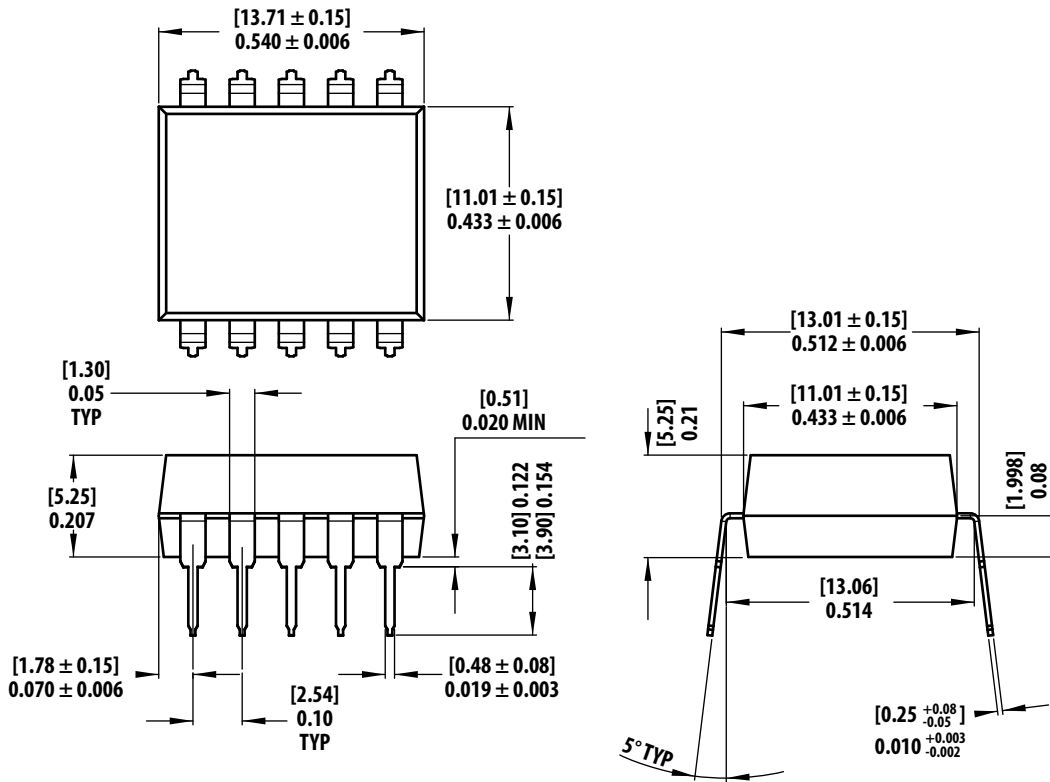

Dimensions in Inches [Millimeters]

10-Pin Widebody (500mils) DIP Package with Gull Wing Surface Mount Option 300

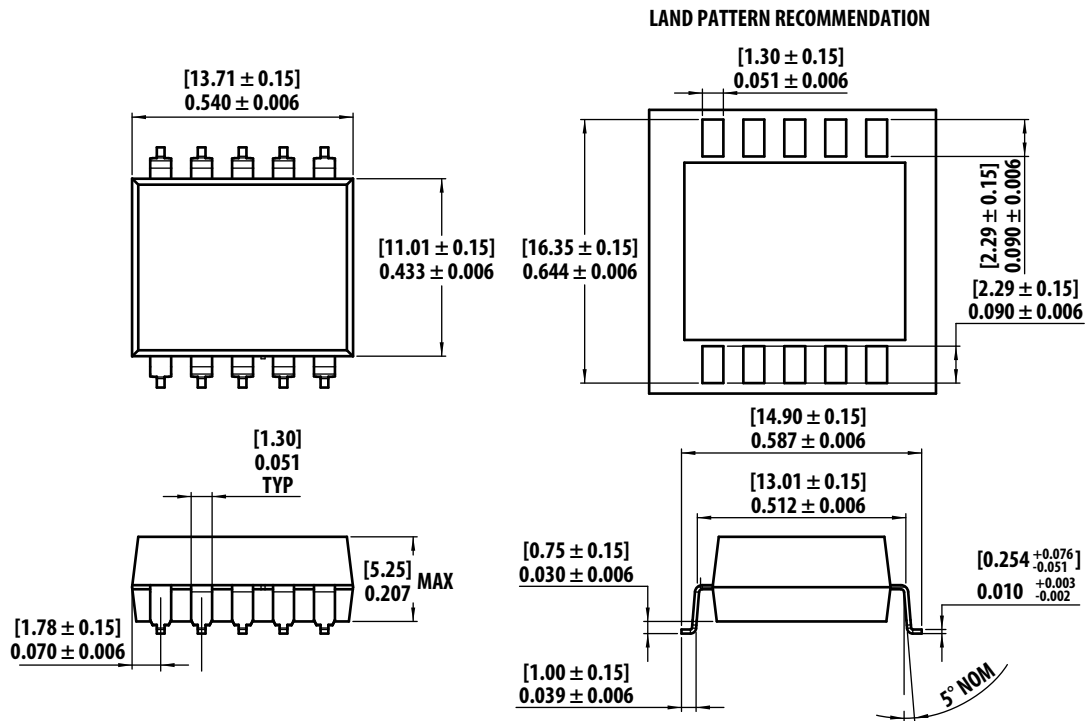

Dimension in Inches [Millimeter]

Solder Reflow Profile

Recommended reflow condition as per JEDEC Standard, J-STD-020 (latest revision). Non-Halide Flux should be used.

Insulation and Safety Related Specifications

Parameter	Symbol	ACNV2601	Units	Conditions
Minimum External Air Gap (External Clearance)	L(101)	13	mm	Measured from input terminals to output terminals, shortest distance through air.
Minimum External Tracking (External Creepage)	L(102)	13	mm	Measured from input terminals to output terminals, shortest distance path along body.
Minimum Internal Plastic Gap (Internal Clearance)		2.0	mm	Through insulation distance conductor to conductor, usually the straight line distance thickness between the emitter and detector.
Minimum Internal Tracking (Internal Creepage)		4.6	mm	Measured from input terminals to output terminals, along internal cavity.
Tracking Resistance (Comparative Tracking Index)	CTI	200	V	DIN IEC 112/VDE 0303 Part 1
Isolation Group		IIIa		Material Group (DIN VDE 0110, 1/89, Table 1)

IEC/EN/DIN EN 60747-5-5 Insulation Characteristics*

Description	Symbol	Characteristic	Unit
Installation classification per DIN VDE 0110/1.89, Table 1 for rated mains voltage $\leq 600 V_{rms}$ for rated mains voltage $\leq 1000 V_{rms}$		I – IV I – III	
Climatic Classification		55/105/21	
Pollution Degree (DIN VDE 0110/1.89)		2	
Maximum Working Insulation Voltage	V_{IORM}	2262	V_{peak}
Input to Output Test Voltage, Method b* $V_{IORM} \times 1.875 = V_{PR}$, 100% Production Test with $t_m = 1$ sec, Partial discharge < 5 pC	V_{PR}	4241	V_{peak}
Input to Output Test Voltage, Method a* $V_{IORM} \times 1.6 = V_{PR}$, Type and Sample Test, $t_m = 10$ sec, Partial discharge < 5 pC	V_{PR}	3619	V_{peak}
Highest Allowable Overvoltage (Transient Overvoltage $t_{ini} = 60$ sec)	V_{IOTM}	12000	V_{peak}
Safety-limiting values – maximum values allowed in the event of a failure.			
Case Temperature	T_S	150	$^{\circ}C$
Input Current**	$I_{S, INPUT}$	400	mA
Output Power**	$P_{S, OUTPUT}$	1	W
Insulation Resistance at T_S , $V_{IO} = 500$ V	R_S	$>10^9$	Ω

* Refer to the optocoupler section of the Isolation and Control Components Designer's Catalog, under Product Safety Regulations section, (IEC/EN/DIN EN 60747-5-5) for a detailed description of Method a and Method b partial discharge test profiles.

** Refer to the following figure for dependence of P_S and I_S on ambient temperature.

Absolute Maximum Ratings

Parameter	Symbol	Min.	Max.	Units
Storage Temperature	T_S	-55	125	°C
Operating Temperature	T_A	-40	105	°C
Average Input Current	$I_{F(AVG)}$		20	mA
Reverse Input Voltage	V_R		3	V
Input Power Dissipation	P_I		40	mW
Supply Voltage (1 Minute Maximum)	V_{CC}		7	V
Enable Input Voltage (Not to Exceed V_{CC} by more than 500mV)	V_E		$V_{CC}+0.5$	V
Enable Input Current	I_E		5	mA
Output Collector Current	I_O		50	mA
Output Collector Voltage	V_O		7	V
Output Collector Power Dissipation	P_O		85	mW
Lead Solder Temperature	T_{LS}		245°C for 10 sec, up to seat plane	

Recommended Operating Conditions

Parameter	Symbol	Min.	Max.	Units	Note
Input Current, Low Level	I_{FL}^*	0	250	μA	
Input Current, High Level	I_{FH}^{**}	9	16	mA	1
Power Supply Voltage	V_{CC}	4.5	5.5	V	
Low Level Enable Voltage	V_{EL}	0	0.8	V	
High Level Enable Voltage	V_{EH}	2.0	V_{CC}	V	
Operating Temperature	T_A	- 40	105	°C	
Fan Out (at $R_L = 1k \Omega$)	N		5	TTL Loads	
Output Pull-up Resistor	R_L	330	4k	Ω	

* The off condition can also be guaranteed by ensuring that $V_{FL} \leq 0.8$ volts.

** The initial switching threshold is 8mA or less. It is recommended that 9mA to 16mA be used for best performance and to permit at least a 20% LED degradation guardband.

Electrical Specifications (DC)

Over recommended operating conditions unless otherwise specified. All typicals at $V_{CC} = 5\text{ V}$, $T_A = 25^\circ\text{C}$.

Parameter	Symbol	Min.	Typ.	Max.	Units	Test Conditions	Fig.	Note
High Level Output Current	I_{OH}		5.5	100	μA	$V_{CC} = 5.5\text{ V}$, $V_E = 2.0\text{ V}$ $V_O = 5.5\text{ V}$, $I_{FL} = 250\ \mu\text{A}$		12
Input Threshold Current	I_{TH}		3.5	8	mA	$V_{CC} = 5.5\text{ V}$, $V_E = 2.0\text{ V}$, $V_O = 0.6\text{ V}$, $I_{OL} > 13\text{ mA}$	1, 2	12
Low Level Output Voltage	V_{OL}		0.35	0.6	V	$V_{CC} = 5.5\text{ V}$, $V_E = 2.0\text{ V}$, $I_F = 8\text{ mA}$, $I_{OL(\text{Sinking})} = 13\text{ mA}$	1, 2, 3, 4	12
High Level Supply Current	I_{CCH}		7.0	12	mA	$V_E = 0.5\text{ V}$ $V_{CC} = 5.5\text{ V}$, $V_E = V_{CC}$ $I_F = 0\text{ mA}$		
Low Level Supply Current	I_{CCL}		9.0	13	mA	$V_E = 0.5\text{ V}$ $V_{CC} = 5.5\text{ V}$, $V_E = V_{CC}$ $I_F = 10\text{ mA}$		
High Level Enable Current	I_{EH}		-0.7		mA	$V_{CC} = 5.5\text{ V}$, $V_E = 2.0\text{ V}$		
Low Level Enable Current	I_{EL}		-0.9		mA	$V_{CC} = 5.5\text{ V}$, $V_E = 0.5\text{ V}$		
High Level Enable Voltage	V_{EH}	2.0			mA	$V_{CC} = 5.5\text{ V}$, $V_E = 2.0\text{ V}$		12
Low Level Enable Voltage	V_{EL}			0.8	mA	$V_{CC} = 5.5\text{ V}$, $V_E = 0.5\text{ V}$		
Input Forward Voltage	V_F	1.25	1.64	1.85	V	$T_A = 25^\circ\text{C}$ $I_F = 10\text{ mA}$		5
		1.2		2.05				
Input Reverse Breakdown Voltage	BV_R	5			V	$I_R = 100\ \mu\text{A}$, $T_A = 25^\circ\text{C}$		
Input Capacitance	C_{IN}		60		pF	$f = 1\text{ MHz}$, $V_F = 0\text{ V}$		
Input Diode Temperature Coefficient	$\Delta V_F/\Delta T_A$		-1.9		mV/ $^\circ\text{C}$	$I_F = 10\text{ mA}$		

Switching Specifications (AC)

Over recommended temperature ($T_A = -40^{\circ}\text{C}$ to 105°C), $V_{CC} = 5\text{ V}$, $I_F = 10\text{ mA}$ unless otherwise specified. All typicals are at $T_A = 25^{\circ}\text{C}$, $V_{CC} = 5\text{ V}$.

Parameter	Symbol	Min.	Typ.	Max.	Units	Test Conditions	Fig.	Note
Propagation Delay Time to High Output Level	t_{PLH}	30	50	80 120	ns	$T_A = 25^{\circ}\text{C}$ $R_L = 350\ \Omega$, $C_L = 15\ \text{pF}$	6, 7, 8	3, 12
Propagation Delay Time to Low Output Level	t_{PHL}	35	55	80 120	ns	$T_A = 25^{\circ}\text{C}$		4, 12
Pulse Width Distortion	$ t_{PHL} - t_{PLH} $		5	40	ns	$R_L = 350\ \Omega$, $C_L = 15\ \text{pF}$	6, 7, 8, 9	6, 12
Propagation Delay Skew	t_{psk}			50	ns			5, 6, 12
Output Rise Time (10%-90%)	T_r		25		ns		10	12
Output Fall Time (10%-90%)	T_f		10		ns		10	12
Propagation Delay Time of Enable from V_{EH} to V_{EL}	t_{ELH}		30		ns	$R_L = 350\ \Omega$, $C_L = 15\ \text{pF}$, $V_{EL} = 0\ \text{V}$, $V_{EH} = 3\ \text{V}$	11, 12	7
Propagation Delay Time of Enable from V_{EL} to V_{EH}	t_{EHL}		20		ns	$R_L = 350\ \Omega$, $C_L = 15\ \text{pF}$, $V_{EL} = 0\ \text{V}$, $V_{EH} = 3\ \text{V}$	11, 12	8
Output High Level Common Mode Transient Immunity	$ CM_H $	20	25		kV/ μs	$V_{CC} = 5\ \text{V}$, $I_F = 0\ \text{mA}$, $V_{O(MIN)} = 2\ \text{V}$, $R_L = 350\ \Omega$, $T_A = 25^{\circ}\text{C}$, $V_{CM} = 1500\ \text{V}$	13	9, 11, 12
Output Low Level Common Mode Transient Immunity	$ CM_L $	20	25		kV/ μs	$V_{CC} = 5\ \text{V}$, $I_F = 10\ \text{mA}$, $V_{O(MAX)} = 0.8\ \text{V}$, $R_L = 350\ \Omega$, $T_A = 25^{\circ}\text{C}$, $V_{CM} = 1500\ \text{V}$		10, 11, 12

All typicals at $T_A = 25^{\circ}\text{C}$.

Parameter	Symbol	Min.	Typ.	Max.	Units	Test Conditions	Fig.	Note
Input-Output Insulation	V_{ISO}	7500			V_{rms}	$RH < 50\%$ for 1 min. $T_A = 25^{\circ}\text{C}$		13, 14
Input-Output Resistance	R_{I-O}	10^{12}			Ω	$V_{I-O} = 500\ \text{V}$		13
Input-Output Capacitance	C_{I-O}		0.5	0.6	pF	$f = 1\ \text{MHz}$, $T_A = 25^{\circ}\text{C}$		13

Notes:

- Peaking circuits may produce transient input currents up to 50 mA, 50 ns maximum pulse width, provided average current does not exceed 20mA.
- By passing of power supply line is required, with a 0.1 μF ceramic disc capacitor adjacent to each optocoupler as illustrated in Figure 15. Total lead length between both ends of the capacitor and the isolator pins should not exceed 20 mm.
- The t_{PLH} propagation delay is measured from the 5 mA point on the falling edge of the input pulse to the 1.5 V point on the rising edge of the output pulse.
- The t_{PHL} propagation delay is measured from the 5 mA point on the rising edge of the input pulse to the 1.5 V point on the falling edge of the output pulse.
- t_{psk} is equal to the worst case difference in t_{PHL} and/or t_{PLH} that will be seen between units at any given temperature and specified test conditions.
- See application section titled "Propagation Delay, Pulse-Width Distortion and Propagation Delay Skew" for more information.
- The t_{ELH} enable propagation delay is measured from the 1.5 V point on the falling edge of the enable input pulse to the 1.5 V point on the rising edge of the output pulse.
- The t_{EHL} enable propagation delay is measured from the 1.5 V point on the rising edge of the enable input pulse to the 1.5 V point on the falling edge of the output pulse.
- CM_H is the maximum tolerable rate of rise of the common mode voltage to assure that the output will remain in a high logic state (i.e., $V_O > 2.0\ \text{V}$).
- CM_L is the maximum tolerable rate of fall of the common mode voltage to assure that the output will remain in a low logic state (i.e., $V_O < 0.8\ \text{V}$).
- For sinusoidal voltages, $(|dV_{CM}| / dt)_{max} = \pi f C_M V_{CM(p-p)}$.
- No external pull up is required for a high logic state on the enable input. If the V_E pin is not used, tying V_E to V_{CC} will result in improved CM_R performance.
- Device considered a two-terminal device: pins 1, 2, 3, 4 and 5 shorted together, and pins 6, 7, 8, 9 and 10 shorted together.
- In accordance with UL1577, each optocoupler is proof tested by applying an insulation test voltage $\geq 9000 V_{rms}$ for one second (leakage detection current limit, $I_{I-O} \leq 5\ \mu\text{A}$). This test is performed before the 100% production test for partial discharge (Method b) shown in the IEC/EN/DIN EN 60747-5-5 Insulation Characteristics Table, if applicable.

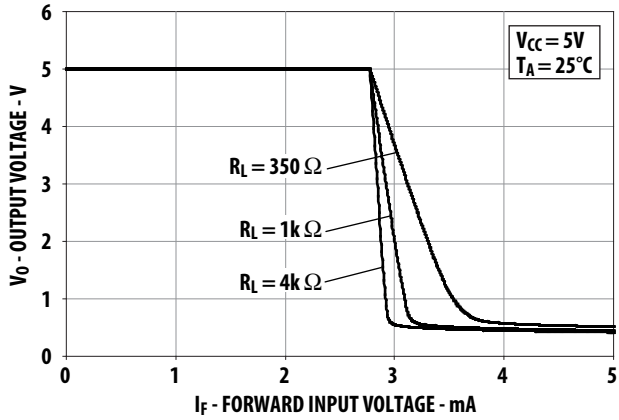

Figure 1. Typical output voltage vs. forward input voltage current

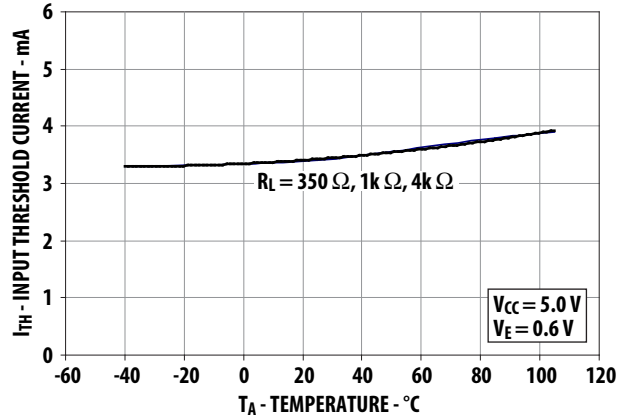

Figure 2. Typical input threshold current vs. temperature

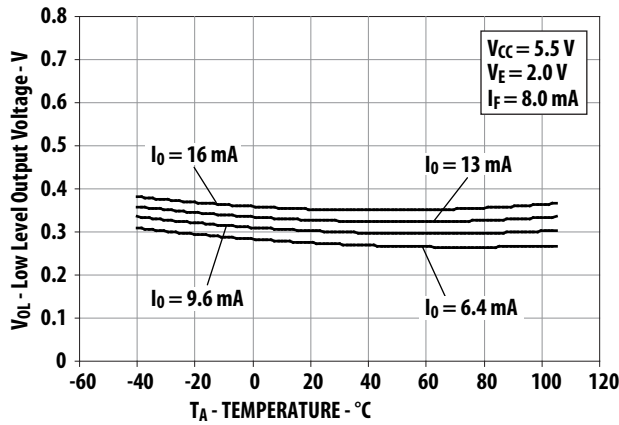

Figure 3. Typical low level output voltage vs. temperature

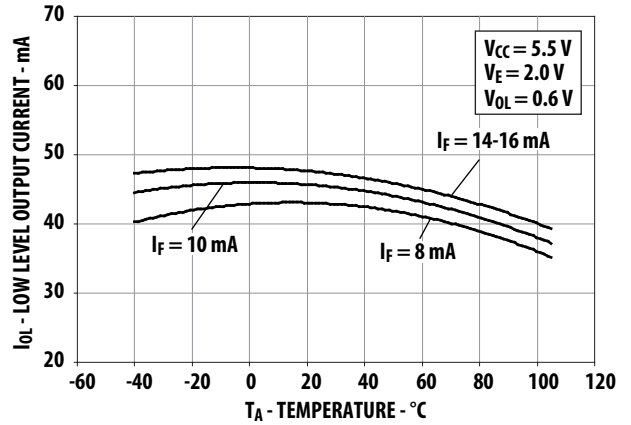

Figure 4. Typical low level output current vs. temperature

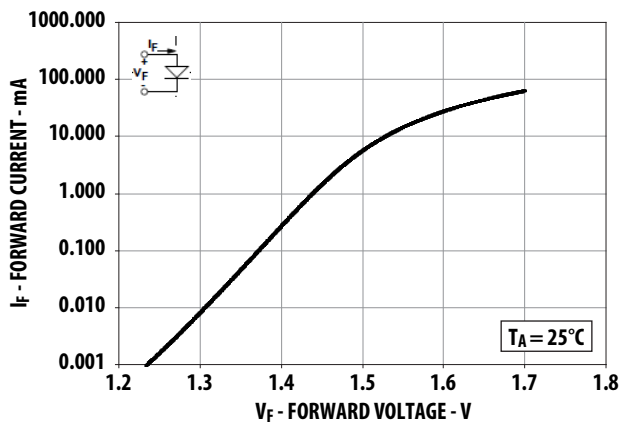

Figure 5. Typical input diode forward characteristic

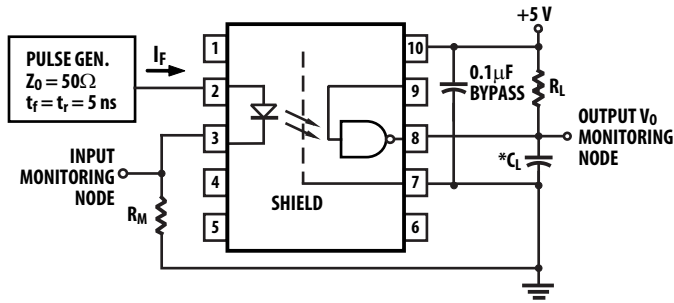

Figure 6. Test circuit for t_{pHL} and t_{pLH}

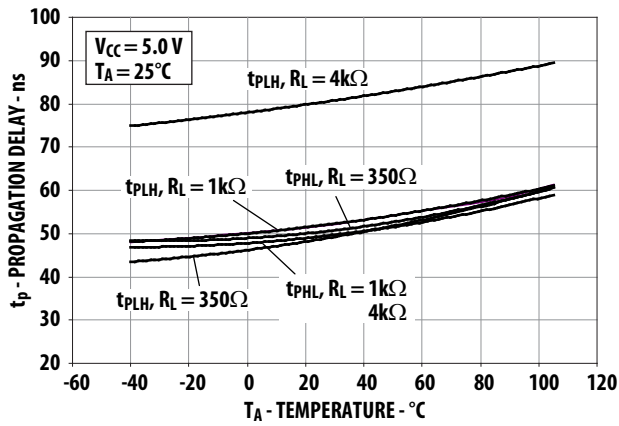
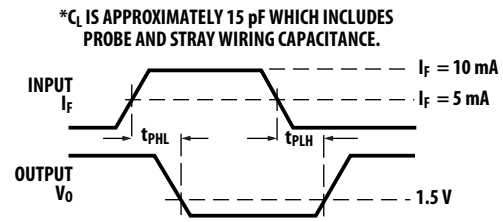

Figure 7. Typical propagation delay vs. temperature

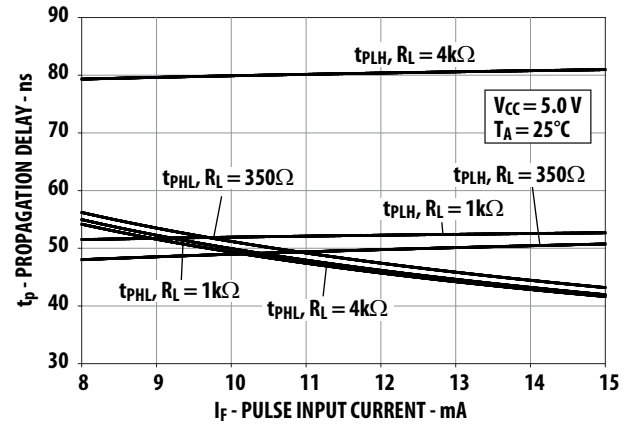

Figure 8. Typical propagation delay vs. pulse input current

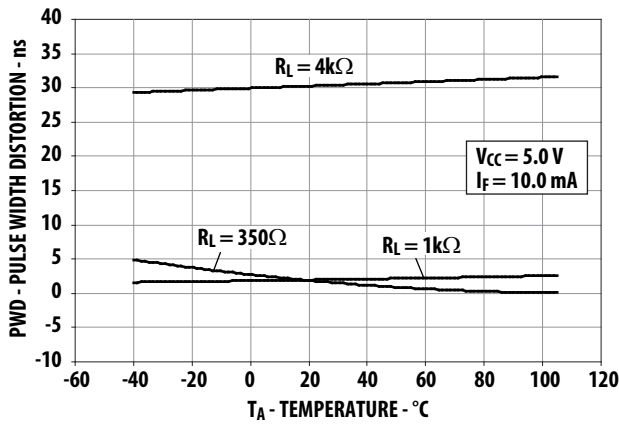

Figure 9. Typical pulse width distortion vs. temperature

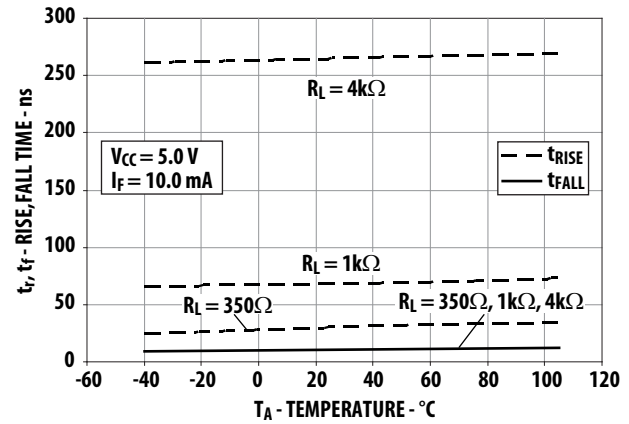
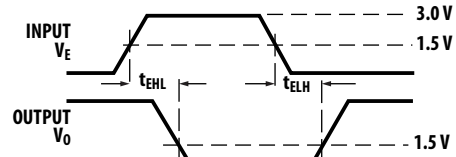
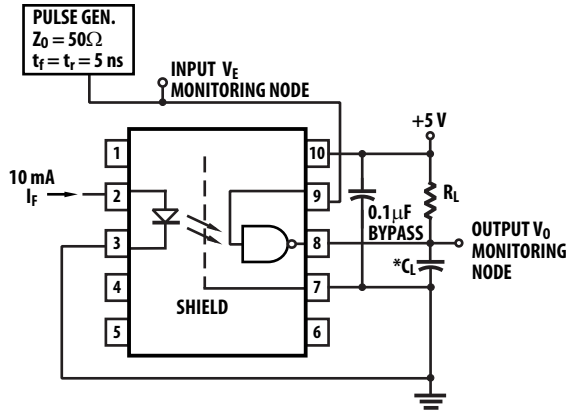

Figure 10. Typical rise and fall time vs. temperature



* C_L IS APPROXIMATELY 15 pF WHICH INCLUDES PROBE AND STRAY WIRING CAPACITANCE.

Figure 11. Test circuit for t_{EHL} and t_{ELH}

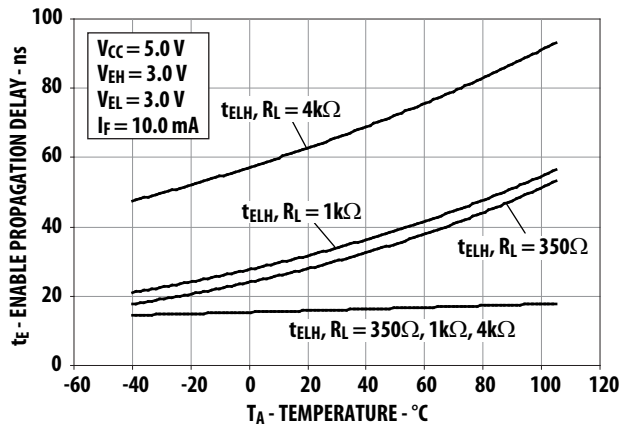

Figure 12. Typical enable propagation delay vs. temperature

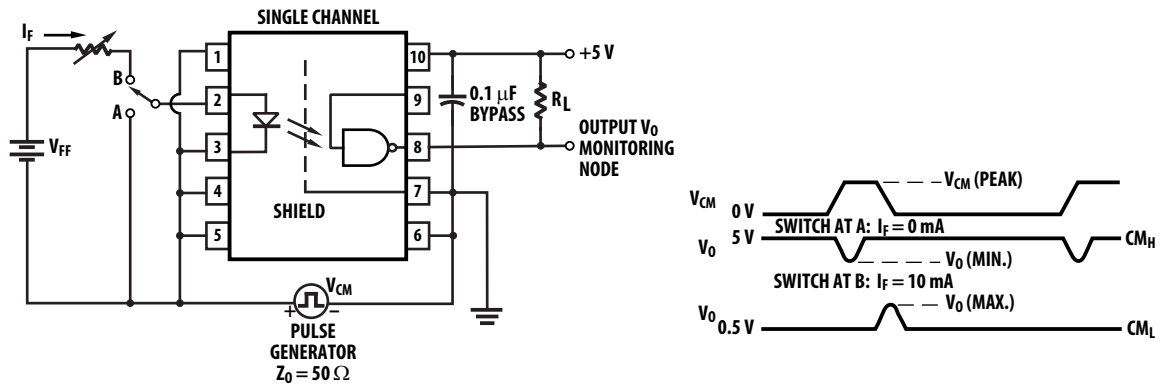

Figure 13. Test circuit for common mode transient immunity and typical waveforms

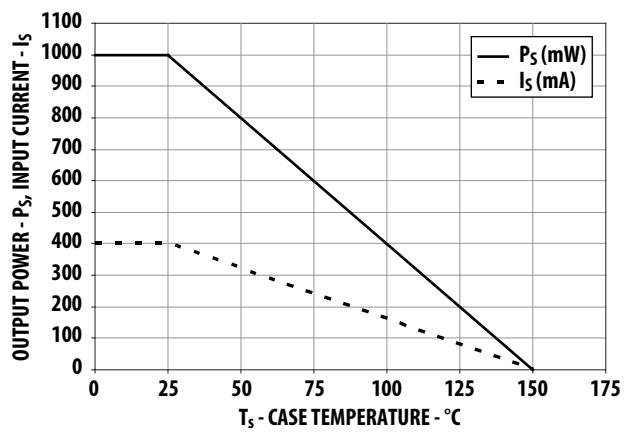

Figure 14. Thermal derating curve, dependence of safety limiting value with case temperature per IEC/EN/DIN EN 60747-5-5

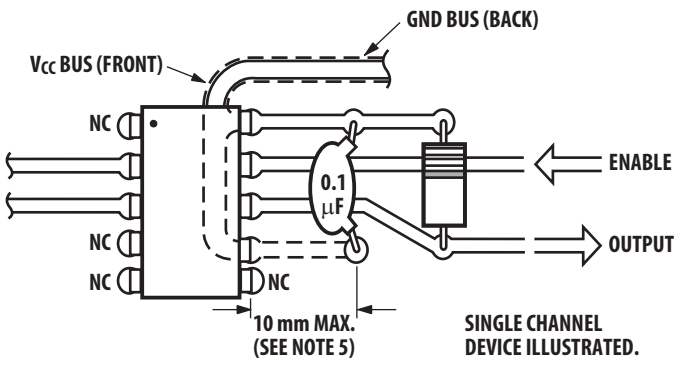

Figure 15. Recommended printed circuit board layout

For product information and a complete list of distributors, please go to our web site: www.avagotech.com

Avago, Avago Technologies, and the A logo are trademarks of Avago Technologies in the United States and other countries. Data subject to change. Copyright © 2005-2013 Avago Technologies. All rights reserved. AV02-2456EN - April 15, 2013

